

SLE6000

Instructions for use
V2.0.98



When the smallest thing matters



SLE Limited
Twin Bridges Business Park
232 Selsdon Road
South Croydon
Surrey CR2 6PL

CE 2797

Telephone: **+44 (0)20 8681 1414**

Fax: **+44 (0)20 8649 8570**

E-mail: **sales@sle.co.uk**

Web site: **www.sle.co.uk**



Emergency Cyber Security contact

E-mail: **customerfeedback@sle.co.uk**

Distributor

This manual is only to be used with:
SLE6000 infant ventilators.

All rights reserved. No part of this publication may be reproduced, stored in any retrieval system, or transmitted in any form or by any means, electronic, mechanical, photocopy, recording or otherwise, without prior permission of SLE.

OxyGenie® is a registered trade mark in the EEA.

© Copyright SLE 21/04/2022
Document ref: UM165/UK Issue 16

REF UM165/UK

Fast index

This index allows users to move directly to the areas of interest.

A full contents page is available on page 5.

Section	Page
Patient circuit selection for invasive ventilation and modification for non invasive ventilation	50
Ventilator setup Invasive ventilation	66
Ventilator setup Non invasive ventilation - Dual limb patient circuit	82
Ventilator setup Non invasive ventilation - Single limb patient circuit	90
Ventilator setup Non invasive ventilation - High flow nasal cannula therapy	94
Invasive mode basic operation	
CPAP	66
CMV	68
PTV	70
PSV	72
SIMV	74
HFOV	76
HFOV+CMV	78
Non invasive mode basic operation - Dual limb patient circuit	
nCPAP	82
NIPPV	84
NIPPV Tr.	86
nHFOV	88
Non invasive mode basic operation - Single limb patient circuit	
NCPAP	90
DuoPAP	92
O2 therapy	94
Technical information	
SpO₂ & etCO₂ sensors	98
OxyGenie®	110
Description of user interface	128
Technical data	147
Troubleshooting	244
Functional testing	252
User Preferences	266
Installation instructions	260

This page is intentionally left blank.

Contents

1. Introduction	14
1.1 Software modules (V2.0).....	14
2. Identifying software and hardware.	15
2.1 Pneumatic module identification for HFOV applicability.....	15
3. Description of the Ventilation Modes (Invasive)	16
3.1 CPAP.....	16
3.2 CMV	16
3.3 PTV	17
3.4 PSV	17
3.5 SIMV	18
3.6 HFOV	19
3.7 HFOV+CMV	19
4. Description of the Ventilation Modes (Non Invasive - Dual limb patient circuits)	20
4.1 nCPAP.....	20
4.2 NIPPV	20
4.3 NIPPV Tr.	21
4.4 nHFOV	21
5. Description of the Ventilation Modes (Non Invasive - Single limb patient circuits)	22
5.1 nCPAP.....	22
5.2 DuoPAP.....	22
6. Description of the Ventilation Modes (Non Invasive - O2 cannula)	22
6.1 O2 therapy	22
7. Intended use of the SLE6000	24
7.1 Summary statement.....	24
7.1.1 Medical indication.....	24
7.1.2 Medical contraindication.....	24
7.1.3 Patient type	24
7.1.4 Body part under treatment	24
7.1.5 Clinical therapy.....	24
7.1.6 Main User Profile.....	24
7.2 Condition of use	24
8. Warnings & Cautions - Ventilator 26	
8.1 Warnings - general.....	26
8.2 Warnings - EMC	27
8.3 Cautions - EMC	27
8.4 Warnings - patient circuit & humidifier	27
8.5 Warnings - nCPAP (single Limb)	28
8.6 Warnings - clinical	28
8.6.1 Monitoring.....	28
8.6.2 Clinical - invasive.....	28
8.6.3 Clinical - non invasive.....	28
8.7 Cautions - general	28
8.7.1 Bacterial filters.....	29
8.7.2 Flow sensor	29
8.8 Cautions - clinical	29
9. Warnings & Cautions - External sensors	29
9.1 Warnings for Masimo SET®	29
9.2 Cautions for Masimo SET®	30
9.2.1 General.....	30
9.2.2 Cleaning	31
9.2.3 Cautions for alarms	31
9.2.4 Cautions for measurements	31
9.2.5 Cautions for Masimo sensors.....	32
9.3 Warnings for Oridion Micropod™	33
9.4 Cautions for Oridion Micropod™	34
10. Warnings & Cautions - OxyGenie®	35
10.1 Warnings for OxyGenie®	35
10.2 Cautions for OxyGenie®	35
10.3 Clinical warnings	35
11. Ventilator layout	38
11.1 Front	38
11.2 Rear	39
12. Ventilator basic setup	42
12.1 Pre-use Inspection	42
12.2 Connection of equipotential bonding cable	42
12.3 Connection of mains power.....	42
12.3.1 IEC/BS 1363/A3 specification power leads	42
12.3.2 Schuko and NEMA specification power leads	42
12.4 Connection of 24V DC auxiliary power.....	42
12.4.1 Mains or auxiliary power supply - power switch status indicator	43
12.5 Fitting the silencer and exhalation block ..	43
12.6 Gas connections.....	43
12.7 Ventilator - patient & operator position	43
12.8 Turning the ventilator On	44

12.8.1 With mains connected	44	14.5 Modification of BC6188 or BC6188/DHW circuits for non-invasive single limb ventilation.	58
12.8.2 Without mains connected	44	14.5.1 Bacterial filters	58
12.8.3 With DC power connected	44	14.5.2 Humidification chamber	58
12.9 Pre-use functional test	44	14.5.3 Fitting the temperature probes	59
12.9.1 Power on self test.....	44	14.5.4 Fitting a single limb nCPAP generator. ...	60
12.9.2 Reserve power check.....	44	14.6 Modification of BC6188 or BC6188/DHW circuits for non-invasive single limb O ₂ therapy.	61
12.9.3 Patient circuit selection	45	61
12.9.4 Pre-functional test checks	45	14.6.1 Bacterial filters	61
12.9.5 Functional testing (Invasive dual limb) ..	45	14.6.2 Humidification chamber	61
12.9.6 Functional testing (Non invasive dual limb)	46	14.6.3 Fitting the temperature probes	62
12.9.7 Functional testing (Non invasive single limb)	46	14.6.4 Fitting a oxygen therapy nasal cannula.	63
12.10 Turning the ventilator Off	47		
12.10.1 Isolation from mains supply.....	47		
13. Battery care and storage instructions	48	15. Ventilation - Invasive	66
13.1 Battery care.....	48	15.1 CPAP	66
13.1.1 Storage less than 6 months.	48	15.2 CMV	68
13.1.2 Storage greater than 6 months.	48	15.3 PTV	70
14. Patient circuit selection	50	15.4 PSV	72
14.1 Type of ventilation	50	15.5 SIMV.....	74
14.1.1 Invasive	50	15.6 HFOV	76
14.1.2 Non-Invasive (Dual limb).....	50	15.7 HFOV+CMV	78
14.1.3 Non-Invasive (Single limb)	50	15.8 Common warnings	80
14.1.4 Non-Invasive O ₂ therapy (Single limb) .	50	15.9 Common cautions	80
14.1.4.1 Patient circuit selection	50	15.9.1 Common alternate functions (Conventional ventilation).....	80
14.2 Assembly of BC6188 (Ø10 mm) or BC6198 (Ø15 mm) patient circuit.....	50	15.9.1.1 Manual breath or Inspiratory hold.....	80
14.2.1 Bacterial filters.....	50	15.9.1.2 O ₂ Boost or O ₂ suction.....	80
14.2.2 Humidification chamber.....	51	15.9.2 Common alternate functions (High frequency ventilation).....	80
14.2.3 Fitting the temperature probes to a BC6188 patient circuit.....	52	15.9.2.1 Sigh or Sigh hold	80
14.2.4 Fitting the temperature probes to a BC6198 patient circuit.....	52	15.9.2.2 O ₂ Boost or O ₂ suction.....	80
14.2.5 Fitting the flow sensor to a BC6188 patient circuit.....	53	15.10 Ventilation without a flow sensor	80
14.2.6 Fitting the flow sensor to a BC6198 patient circuit.....	53		
14.2.7 Fitting the test lung.....	53	16. Non-invasive - Dual limb	82
14.3 Assembly of BC6188/DHW patient circuit	54	16.1 nCPAP D	82
14.3.1 Bacterial filters.....	54	16.2 NIPPV D	84
14.3.2 Humidification chamber.....	54	16.3 NIPPV Tr.....	86
14.3.3 Fitting the test lung.....	56	16.4 nHFOV	88
14.4 Modification of BC6188 or BC6188/DHW circuits for non-invasive dual limb ventilation. ...	57	17. Non-invasive - Single limb	90
14.4.1 Fitting a dual limb nCPAP generator.	57	17.1 nCPAP S	90
		17.2 DuoPAP	92
		17.3 O ₂ therapy.....	94
		17.4 Common warnings	96
		17.5 Common cautions	96
		17.6 Common note.....	96
		18. SpO₂ and etCO₂ monitoring	98
		18.1 SpO ₂ monitoring (Masimo SET).....	98
		18.1.1 Principle of Operation.....	98
		18.2 Masimo SET [®] Connection	99

18.2.1 Connection to ventilator	99	18.21 Cleaning the MicroPod™ Enclosure	107
18.2.2 Disconnection.....	99	19. OxyGenie®	110
18.2.3 Selection of Masimo SET® Sensors.....	99	19.1 Introduction.....	110
18.2.4 Sensor application sites	99	19.1.1 OxyGenie® modes of operation.....	110
18.2.5 Connection of a sensor	99	19.1.1.1 Auto mode	110
18.2.6 Disconnection.....	99	19.1.1.2 Fallback mode:.....	110
18.3 Configuration.....	100	19.1.1.3 Manual override.....	111
18.3.1 SpO ₂ monitoring ON/OFF	100	19.1.1.4 Inactive mode	111
18.3.2 FastSat™	100	19.2 OxyGenie® Fall back mode.....	111
18.3.3 Averaging Time	100	19.2.1 Checking the OxyGenie® response.....	111
18.3.4 Alarm Delay	100	19.2.2 Activating OxyGenie®	111
18.3.5 Auto O ₂ : SpO ₂ Target range limits	100	19.2.3 Deactivating OxyGenie®	111
18.3.6 SpO ₂ Sensitivity	100	19.2.4 Activating manual override	112
18.3.7 Rapid Desat	101	19.2.5 Changing the SpO ₂ target range.....	112
18.3.8 Perf Index.....	101	19.2.6 Averaging Time.....	112
18.4 Monitored values.....	101	19.3 SpO ₂ Waveform display option and OxyGenie®	112
18.5 SpO ₂ alarms thresholds	101	19.4 OxyGenie® and O ₂ Boost.....	113
18.6 SpO ₂ Waveform and display options	101	19.5 OxyGenie® and O ₂ Suction.....	113
18.7 Standard Waveform display option	102	20. Operational features	116
18.7.0.1 SpO ₂ and etCO ₂ dual waveform display	102	20.1 General.....	116
18.8 SpO ₂ Waveform display option	102	20.1.1 Standby Mode	116
18.8.1 SpO ₂ Waveform in O ₂ therapy.....	103	20.1.2 Apnoea alarm set to “Off”	116
18.9 SpO ₂ module testing	103	20.1.3 Reserve power source	116
18.10 Operation during mains power interruption (Mains power fail).....	103	20.1.4 Parameter Memory.....	116
18.11 EtCO ₂ monitoring (MicroPod™)	104	20.1.5 HFO variable I:E ratio (Only available with HFOV and nHFOV options).....	116
18.11.1 Principle of Operation	104	20.1.6 Pressure Support Breaths Not Delivered as Set.....	117
18.11.2 Connection to ventilator.....	104	20.1.7 Trigger sensitivity.....	117
18.11.3 Initialization Time.....	104	20.1.8 Volume Targeted Ventilation, Vte (VTV)	117
18.11.4 Disconnection.....	104	20.1.8.1 Ti.....	117
18.11.5 Mounting of module.....	104	20.1.8.2 Vte Target Resolution	117
18.11.6 Connection of a FilterLine™	105	20.1.9 Max Ti in PSV.....	117
18.12 Configuration.....	105	20.1.10 Suctioning (Closed suction).....	117
18.12.1 EtCO ₂ Monitoring	105	20.1.11 VTV & HFOV	117
18.12.2 Pump control	105	20.1.11.1 Vte Target Resolution	117
18.12.3 Breath absence alarm time	105	20.2 Types of leak compensation	118
18.12.4 Device information	105	20.2.1 VTV and patient leak	118
18.13 Waveforms	106	20.2.2 NIV modes and patient leak	118
18.13.0.1 EtCO ₂ and SpO ₂ dual waveform display	106	20.2.3 PSV mode automatic leak Compensation	118
18.14 Monitored values.....	106	20.3 O ₂ Suction.....	118
18.15 EtCO ₂ alarms thresholds	106	20.4 O ₂ Boost	119
18.16 Flow measurement compensation when using side stream etCO ₂ monitoring.....	106	20.5 Alarm thresholds.....	120
18.17 EtCO ₂ module testing	106	20.5.1 Alarm thresholds for conventional modes (invasive and non invasive - dual limb).	120
18.18 EtCO ₂ module Calibration.....	106	20.5.2 Alarm thresholds for Oscillatory modes (invasive and non invasive - dual limb).	121
18.19 Operational notes related to etCO ₂ monitoring using MicroPod™	107	20.5.2.1 HFOV & nHFOV	121
18.20 Operation during mains power interruption (Mains power fail).....	107	20.5.2.2 HFOV+CMV (invasive - dual limb)	122

20.5.3 Alarm thresholds for conventional modes (non invasive - single limb)..... 122

20.5.4 High pressure threshold alarm operation.123

20.5.5 Low pressure threshold alarm operation123

20.6 Patient Circuits, Humidification and Nitric Oxide Therapy 124

20.6.1 Invasive ventilation & autofeed humidification chambers 124

20.6.2 Non-Invasive ventilation & autofeed humidification chambers 124

20.6.3 Nitric Oxide Therapy 124

20.6.4 Nebulization of Medication 125

20.6.4.1 Nebulization using Aerogen® 125

20.7 Using the SLE6000 with SLE500E and SLE500S medical air compressors 125

21. User interface description 128

21.1 Standby mode 128

21.1.1 User interface (1) 128

21.1.2 Information panel (2)..... 128

21.1.3 Information bar (3)..... 128

21.1.4 Generic button/panel functions 128

21.1.4.1 Panel functions..... 128

21.1.4.2 Parameter time out..... 128

21.1.4.3 Panel time out 128

21.1.4.4 Button states 128

21.1.4.5 Mode button (A) 128

21.1.4.6 Start/Resume Ventilation button (E)... 128

21.1.4.7 Alarms (B) 128

21.1.4.8 Utilities button (C)..... 128

21.1.4.9 Calibration & Utilities button (F) 129

21.1.4.10 Layout button (D) 129

21.1.4.11 Multi function button (G)..... 129

21.1.5 Mode button & Start/Resume Ventilation button 129

21.1.6 Alarm button 129

21.1.6.1 Limits tab 129

21.1.6.2 History tab 130

21.1.6.3 Loudness tab..... 130

21.1.7 Utilities & Calibration & Utilities button.. 130

21.1.7.1 Sensors tab (without external sensor/s) 131

21.1.7.2 Sensors tab (with external sensor/s) 131

21.1.7.3 Brightness tab 131

21.1.7.4 System Tab 132

21.1.7.5 Data tab..... 133

21.1.7.6 Downloading screen captures..... 134

21.1.8 Layout Tab..... 135

21.1.8.1 Waveforms 135

21.1.8.2 Loops 136

21.1.9 Capturing, Retrieving & Deleting Loops. 136

21.1.9.1 To capture Loops..... 136

21.1.9.2 Trends 137

21.1.9.3 Single & double trend display 138

21.1.9.4 Viewing trends 138

21.2 Ventilation mode 140

21.2.1 Alarm mute and pre-mute button (A) 140

21.2.2 Parameters 140

21.2.2.1 Parameter types 140

21.2.2.2 Parameter states 140

21.2.2.3 Modifying a parameter..... 140

21.2.2.4 Turning “ON” a parameter function.... 140

21.2.3 Preview mode..... 141

21.2.4 Patient circuit selection..... 141

21.2.5 Monitored values 141

21.2.5.1 Single column/double column layout.. 141

21.2.6 Alarms tab - ventilatory mode 142

21.2.6.1 Adjusting an alarm threshold 142

21.2.6.2 Alarm auto tracking/auto set thresholds 142

21.2.7 History and Loudness..... 143

21.2.8 Utilities tab - ventilatory mode 143

21.2.8.1 Flow sensor calibration..... 143

21.2.8.2 O₂ calibration 144

21.2.9 Brightness tab - ventilatory mode..... 144

21.2.10 System tab - ventilatory mode..... 144

21.2.11 Data tab - ventilatory mode 144

21.2.12 Layout..... 144

21.2.13 Lock screen button 144

21.2.14 Pause/play..... 144

21.2.15 Screen capture 144

21.2.16 Alarm bar 145

21.2.17 Mode specific controls..... 145

21.2.17.1 Manual breath (Inspiratory Hold)..... 145

21.2.17.2 Sigh (Sigh Hold) 145

21.2.18 Oscillation Pause..... 145

21.2.19 HFO Activity..... 145

22. Technical description 148

23. Description of ventilatory modes (Invasive) 149

23.1 CPAP 149

23.2 CMV 149

23.2.1 CMV & VTV 149

23.3 PTV 149

23.3.1 PTV & VTV 149

23.4 PSV 149

23.4.1 PSV & VTV 149

23.5 SIMV 149

23.5.1 SIMV with P Support 150

23.5.2 SIMV & VTV 150

23.6 HFOV 150

23.6.1 HFO & VTV 150

23.7 HFOV+CMV 150

24. Description of ventilatory modes (Non-invasive)	150	27.5.2 Volume controlled breath accuracy	165
24.1 nCPAP (Dual and Single limb)	150	27.5.3 Pressure controlled breath accuracy (Invasive Ventilation)	165
24.2 NIPPV (Dual limb)	150	27.5.4 Pressure controlled breath accuracy (Non-invasive Ventilation).....	165
24.3 NIPPV Tr. (Dual limb)	150	27.5.5 Measured parameters	165
24.4 nHFOV (Dual limb only)	150	27.5.5.1 Oxygen Concentration	166
24.5 O ₂ Therapy (Single limb only)	150	27.5.5.2 Pressure	166
25. Oxygen Calibration Routines	151	27.5.5.3 Trends	166
25.1 One Point O ₂ Calibration.....	151	27.5.5.4 Sound pressure level.....	166
25.2 Two Point O ₂ Calibration.....	151	27.5.5.5 Exhalation Block Port Jet Sizes	166
26. N5402-REV2 & N5302 flow sensor	152	27.5.6 BS EN ISO 80601-2-12 Disclosure	167
26.1 Calibration of the Flow Sensor	152	27.5.7 Measurement uncertainties	167
26.2 Cleaning and high level disinfection of the N5402-REV2 Sensor.....	153	27.6 Patient circuits.....	167
26.2.1 Cleaning:	153	27.7 Breathing system filters	167
26.2.2 Disinfection:.....	153	27.7.1 N3029.....	167
26.2.3 High level disinfection	153	27.7.2 N3587.....	167
27. Technical specification	154	27.7.3 N3588.....	168
27.1 Operating Modes - Conventional Invasive Ventilation	154	27.7.4 N3688.....	168
27.1.1 CPAP mode.....	154	27.7.5 N3590.....	168
27.1.2 CMV mode	154	27.8 Maximum limited Pressures	168
27.1.3 PTV mode	155	27.9 Gas supplies	168
27.1.4 PSV mode	155	27.9.1 Oxygen supply	168
27.1.5 SIMV mode	156	27.9.2 Air supply	168
27.1.6 HFOV mode	157	27.10 Service life	168
27.1.7 HFOV+CMV mode	157	27.11 Power, Dimensions, Classification.....	168
27.2 Operating Modes Conventional Non Invasive Ventilation	158	27.11.1 Power AC.....	168
27.2.1 nCPAP D mode (Dual Limb).....	158	27.11.2 Power DC	168
27.2.2 NIPPV D mode (Dual Limb)	158	27.12 Operating Environment	169
27.2.3 NIPPV Tr. mode (Dual Limb).....	158	27.12.1 Connectors	169
27.2.4 nHFOV mode (Dual Limb).....	159	27.13 Classification (Electrical)	169
27.2.5 nCPAP S mode (Single Limb)	159	27.14 GMDN classification number	169
27.2.6 DuoPAP mode (Single Limb).....	159	27.15 IP rating	169
27.2.7 O ₂ therapy (Single Limb)	160	27.16 Environmental Storage Conditions.....	169
27.2.8 OxyGenie	160	28. Output ports (Electrical)	170
27.2.8.1 OxyGenie PCLCS attributes	160	28.1 RS232 port	170
27.3 Mode of operation	160	28.2 SLE6000 basic data output (V2.0).	170
27.4 Controls.....	160	28.2.1 SLE6000 basic data output specifications (V2.0).....	170
27.4.1 Power Button	160	28.2.2 Communications Settings (V2.0).....	170
27.4.2 User Interface.....	160	28.2.2.1 Data Rate & Size (V2.0)	170
27.4.2.1 Buttons	160	28.2.2.2 Data Format	170
27.4.2.2 Tabs.....	163	28.2.3 Data Layout.....	170
27.4.2.3 Controls	163	28.2.4 Data Format	171
27.5 Measurement	165	28.3 SLE6000 enhanced data output (V3.0)....	176
27.5.1 Flow sensor.....	165	28.3.1 SLE6000 enhanced data output specifications (V3.0).....	176
		28.3.2 Communications Settings (V3.0).....	176
		28.3.2.1 Data Rate & Size (V3.0)	176
		28.3.2.2 Data Format	176
		28.3.3 Data Layout.....	176

28.3.4 Data Format	177	31.7 “Monitor hardware fault” fault table.....	221
28.4 Vuelink & IntelliBridge EC10.....	184	32. Sensor Alarms	222
28.4.1 Connecting to the VueLink patient monitor	184	32.1 Alarm Priorities	222
28.4.2 Connecting to the IntelliBridge EC10 module	184	32.1.1 Status messages.....	222
28.4.3 Parameter Descriptions.....	185	32.2 SpO ₂ monitoring (System alarms).....	223
28.4.4 Alarm messages.....	186	32.3 SpO ₂ monitoring (Patient alarms).....	226
28.4.5 Waveform	188	32.4 EtCO ₂ monitoring (System alarms).....	227
28.4.6 VueLink Task Window Layout	188	32.5 EtCO ₂ monitoring (Patient alarms).....	230
28.5 Nurse call	189	33. Sensor Status messages	232
28.5.1 Nurse call delay.....	189	33.1 SpO ₂ Status messages	232
28.6 Ethernet.....	189	33.2 EtCO ₂ Status messages	233
28.7 USB (Data).....	189	34. Cleaning and disinfection	235
28.8 USB (Power)	189	34.1 Instructions	235
28.9 External Monitor	189	34.2 External surface cleaning instructions.....	235
29. Input ports (Electrical)	190	34.3 External surface disinfection instructions	236
29.1 SpO ₂ and etCO ₂	190	34.4 Exhalation block cleaning instructions.....	236
29.2 Flow sensor.....	190	34.5 Exhalation block disinfection instructions	236
29.3 DC 24V.....	190	34.6 Reusable Silencer disinfection instructions	236
30. Sensor Specifications	190	34.7 Gas jet ports disinfection	236
30.1 Masimo SET®	190	34.8 Occlusion valve	236
30.1.1 Functional SpO ₂ (%)	190	34.9 Cleaning of main air intake filter	236
30.1.2 Pulse rate (BPM).....	190	35. EMC compliance	237
30.1.3 Perfusion index (%).....	191	35.1 Emissions test compliance levels.....	237
30.1.3.1 Senor Wavelength range	191	35.2 Immunity tests compliance levels.....	237
30.1.4 Accuracy notes.....	191	35.3 Warnings - EMC	238
30.1.5 Environmental	192	35.4 Cautions - EMC	238
30.1.5.1 Operating Conditions	192	36. Pneumatic unit diagram	239
30.1.5.2 Storage Conditions.....	192	36.1 HFO capable pneumatic unit.....	239
30.1.5.3 Implied license statement.....	192	36.2 Conventional pneumatic unit.....	240
30.2 MicroPod™	192	36.3 Patient circuit pneumatic diagrams	241
30.2.1 Alarm limits.....	193	37. Software version identification ..	242
30.2.2 Measurement formats	193	38. Troubleshooting Chart	244
30.2.3 Calculation methods for Capnography..	193	38.1 Ventilation Related Problems	244
30.2.4 Environmental	193	38.2 Ventilator Related Problems.....	246
30.2.4.1 Operating Conditions	193	38.3 Sensor Related Problems	249
30.2.4.2 Storage Conditions.....	193	39. Planned preventative Maintenance (PPM)	252
30.2.4.3 Trademarks	193	39.1 PPM schedule	252
31. Alarms	194	39.2 PPM kits	252
31.1 Alarm Prioritization	194	39.2.1 Kit A.....	252
31.1.1 Alarm Characteristics	194	39.2.2 Kit B.....	252
31.1.2 Alarm sounder volume	194	39.3 Kit part numbers.....	252
31.1.3 Alarm log	194		
31.2 Alarm Indicators characteristics	194		
31.3 Alarm table	197		
31.4 “Power supply fault” fault table.....	219		
31.5 “Ventilator out of calibration” fault table....	220		
31.6 “Controller hardware fault” fault table.....	221		

39.4 Mains cable replacement	252	43.1.5 Regional tab	268
39.5 MicroPod™ PPM.....	253	43.1.6 Save / Quit tab.....	268
40. Ventilator Functional testing	253	44. SLE 6000 Event and Patient Log	270
40.1 Alarm testing	253	viewer software	270
40.1.1 High Oxygen/Low Oxygen/Loss of gas supply		44.1 Minimum system requirements	270
alarm test	253	44.1.1 Memory stick requirements	270
40.1.2 Obstruction alarm - Blocked fresh gas ..	254	44.2 Installation of software.....	270
40.1.3 Partial occlusion alarm - Continuing positive		44.3 Downloading the Patient log or Event log	
pressure	254	270
40.1.4 High Pressure alarm - High pressure		44.4 Export file formats	271
threshold exceeded.....	254	44.4.1 File types	271
40.1.5 Expired volume alarm - Tidal volume above/		44.4.1.1 RealtimeLog	271
below threshold	254	44.4.1.2 AlarmsLog	271
40.1.6 Volume alarm - Minute volume above/below		44.4.1.3 TrendsDataLog.....	272
threshold	254	44.4.1.4 SystemLog	272
40.1.7 Power supply failure alarm - Main power fail		44.4.1.5 DebugLog.....	272
and battery check.....	254	44.4.1.6 Log records	272
40.2 Performance testing.....	255	44.5 Log Viewer Features	273
40.2.1 Conventional	255	44.5.1 Load Files.....	273
40.2.2 Oscillatory	255	44.5.2 Export to XML.....	273
41. External sensor functional testing		44.5.3 Export to Excel	273
.....	256	44.5.3.1 Events Log / Trends Log	273
41.1 Masimo SET®.....	256	44.5.4 Search Filter.....	274
41.1.1 Masimo SET® Functional testing	256	44.5.5 Load Trend data by day.....	274
41.1.2 Masimo SET® SpO ₂ and PR alarms.....	256	44.5.6 Trends Settings	274
41.2 MicroPod™	257	44.5.6.1 Trends button	274
41.2.1 MicroPod™ Functional testing	257	44.5.6.2 Trend Data button.....	274
41.2.2 MicroPod™ etCO ₂ alarm	257	44.5.7 All Trends	274
42. Installation instructions	260	44.5.8 Load Real-time Data	274
42.0.1 Tools required for trolley assembly.....	260	44.5.8.1 Wave Data.....	274
42.1 Unpacking.....	260	44.5.8.2 Entire Waves	274
42.2 Medicart assembly	261	44.5.8.3 Waves.....	274
42.2.1 Medicart kit contents	261	44.5.9 “UTAS” option.....	275
42.2.2 Assembly.....	261	44.5.10 Timeline	275
42.3 Ventilator unpacking.....	262	44.5.11 Display data from last day	275
42.4 Ventilator lifting points	263	45. Training (User)	277
42.5 Ventilator assembly to Medicart	263	46. Training (service)	277
42.6 Mains cable attachment	264	47. Consumables & Accessories	280
42.7 Pre-use functional test.	264	48. Glossary	285
42.8 Ventilator configuration.....	264	49. SLE6000 markings and symbols	287
43. User preferences	266	49.1 Description of ventilator markings	287
43.1 Accessing user preferences	266	49.2 Description of option markings	288
43.1.1 Parameters tab.....	266	49.3 Description of interface markings.	288
43.1.1.1 Parameters.....	266	49.4 Description of Micropod™ markings.	290
43.1.2 Ventilation tab.....	267	49.5 Description of Packaging markings.....	290
43.1.3 Alarms tab	267		
43.1.4 Interface tab	268		

This page is intentionally left blank.

Introduction



1. Introduction

The SLE6000 infant ventilator running version 2.0 software is modular in design. This release has 9 modules that fit into the core module.

The graphic below shows how all the modules when purchased interface with the core module.

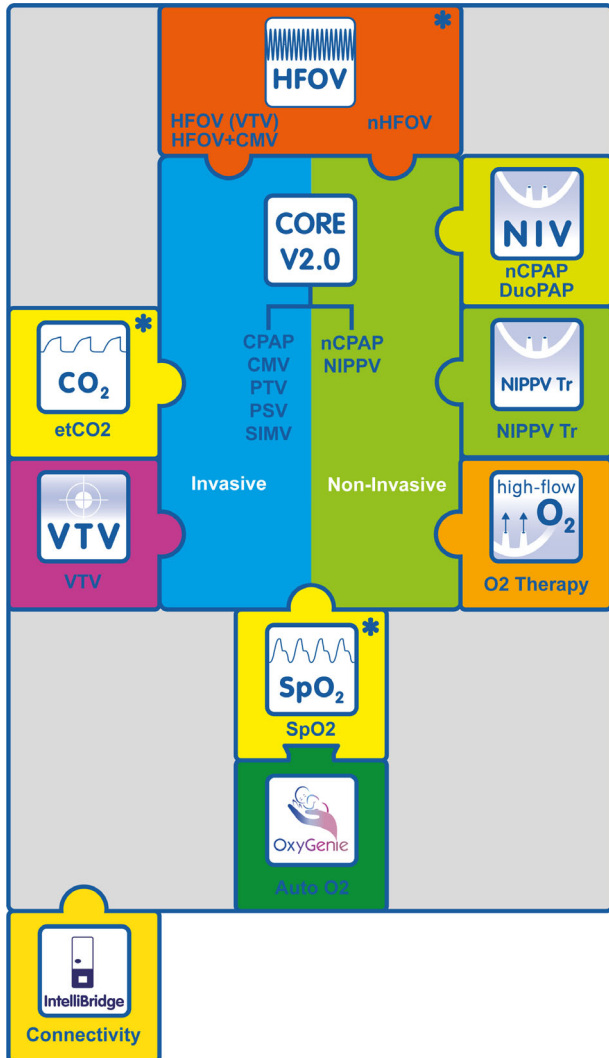

The software modules with an asterisk (*) require additional hardware.

For HFOV the ventilator requires the HFO module. (Factory fitted or service upgrade).

For CO₂ the user will have to purchase the etCO₂ module and accessories.

For SpO₂ the user will have to purchase the SpO₂ module and sensors.

For CO₂ and SpO₂ modules and accessories see Section '47. Consumables & Accessories' on page 280.

1.1 Software modules (V2.0)

CORE V2.0 **Core Configuration Software Module**
Core software is installed on all SLE6000 ventilators and includes invasive modes (CPAP, CMV, PTV, PSV, SIMV) and non-invasive modes (nCPAP, NIPPV) as standard.

HFOV **SLE6000 HFOV (including HFOV VTV) Software Module**
This software module adds HFOV to the SLE6000 allowing both invasive and non-invasive (dual limb) HFOV. Invasive HFOV includes VTV as standard.

Note: The software module requires the HFO pneumatic module to be installed.

NIV **SLE6000 Single Limb NIV Software Module**
This software module adds the facility to ventilate using nCPAP and DuoPAP with a single limb circuit.

NIPPV Tr **SLE6000 NIPPV Tr. Software Module**
This software module adds the facility to ventilate using NIPPV with support of patient triggered breaths with a dual limb circuit.

high-flow O₂ **SLE6000 Oxygen Therapy Software Module**
This software module adds the facility to use nasal O₂ therapy sets with a single limb circuit.

VTV **SLE6000 VTV (Conventional Ventilation) Software Module**
This software module adds VTV to all of the conventional invasive monitoring modes.

CO₂ **SLE6000 etCO₂ Monitoring Software Module**
This software module adds etCO₂ software that allows an Oridion MicroPod™ to interface with the SLE6000. It requires an Oridion MicroPod™ and neonatal sampling lines.



SLE6000 Masimo SpO₂ Monitoring Software Module

This software module adds SpO₂ software that allows a Masimo uSpO₂ module to interface with the SLE6000. It requires a SLE uSpO₂ cable (Masimo SET) and infant, neonatal and neonatal/paediatric SpO₂ sensors.



SLE6000 OxyGenie® Software Module

This software module adds the Auto-O₂ system that is intended to control the inspired oxygen delivery, to keep the SpO₂ of the patient within a predefined range of SpO₂.



SLE6000 IntelliBridge Software Module

This software module adds the connectivity to the external monitoring systems provided by the Philips Vuelink and IntelliBridge modules.

2. Identifying software and hardware.

To identify the software modules refer to the icon panel on the side of the ventilator.

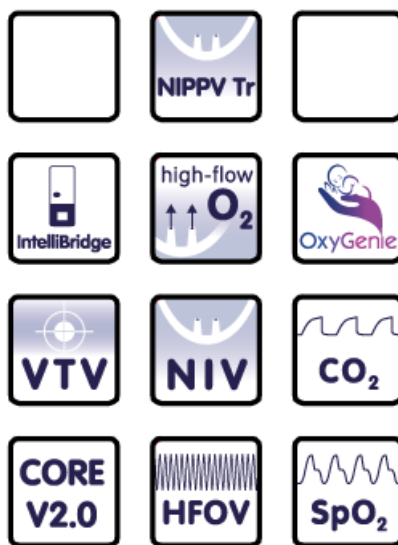
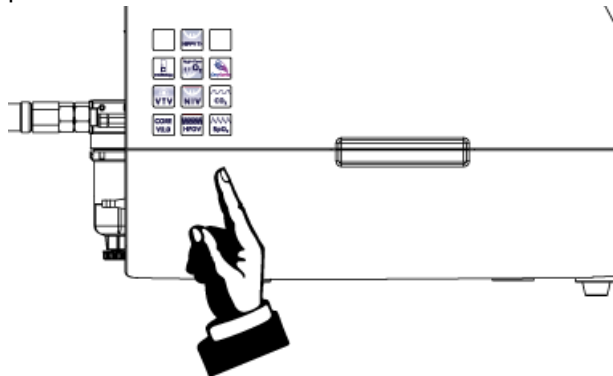

For your ventilator the installed software modules will be shown in the ICON panel.

2.1 Pneumatic module identification for HFOV applicability

To confirm if you can install the HFOV module please refer to the ventilators serial number (Located on the rear of the ventilator).

If the second digit of the number is zero (60104612345) then the HFOV software can be installed.

If the second digit of the number is five (651048612345) then a pneumatic unit upgrade is required to allow the HFOV software module to activate. (Please contact SLE or your distributor for more information).

3. Description of the Ventilation Modes (Invasive)

The ventilator has the ability to be used as either a pressure controlled, volume targeted ventilator, as a pressure limited, time cycled ventilator, and as a high frequency oscillation ventilator (Only available with HFOV option).

3.1 CPAP

Continuous Positive Airway Pressure

**CORE
V2.0**

The ventilator generates a continuous positive airway pressure at a level set by the User. The apnoea alarm will sound if the patient has not made any breath attempts within the set apnoea period.

User sets the following:-

- Ti (Inspiratory time)
- CPAP
- PIP
- O₂%

Additional features

- RR backup
- Rise time
- Trigger Sensitivity (Flow or Pressure breath detection threshold)

Alarms

- High and low PIP
- High and low CPAP
- High RR
- Apnoea time (Can be turned OFF)

Alarms available when flow sensor connected

- High and low V_te
- High and low V_{min}
- Percentage leak (Active when flow sensor connected)

Additional items

- Manual breath or Inspiratory hold button

Features with SpO₂ module

- Pleth waveform when selected
- High and low SpO₂ alarm thresholds
- High and low PR alarm thresholds



OxyGenie® + SpO₂ module

- SpO₂ target range
- High O₂% alarm

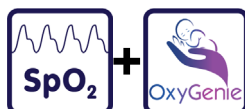

Features with etCO₂ module

- etCO₂ waveform when selected
- High and low etCO₂ alarm thresholds

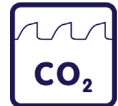

3.2 CMV

Continuous Mandatory Ventilation

**CORE
V2.0**

In this mode the inspiratory cycle is initiated by the ventilator at a set RR rate. The breaths are time cycled.

User sets the following:-

- PEEP
- PIP
- RR (Respiratory rate)
- Ti (Inspiratory time)
- O₂%

Additional features

- Rise time

Alarms thresholds

- High and low PIP
- High and low PEEP

Alarms available when flow sensor connected

- High and low V_te
- High and low V_{min}
- Percentage leak

Additional items

- Manual breath or Inspiratory hold button

Features with VTV module

- VTV of CMV breaths



Features with SpO₂ module

- Pleth waveform when selected
- High and low SpO₂ alarm thresholds
- High and low PR alarm thresholds



OxyGenie® + SpO₂ module

- SpO₂ target range
- High O₂% alarm

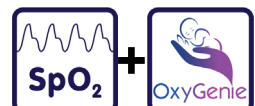

Features with etCO₂ module

- etCO₂ waveform when selected
- High and low etCO₂ alarm thresholds



3.3 PTV

Patient Triggered Ventilation

**CORE
V2.0**

In this mode all the patient's breath attempts are pressure supported. Mechanical breaths are delivered at the set parameters (Ti, PEEP and PIP) if no patient effort is recognised.

User sets the following:-

- RR (Respiratory rate)
- Ti (Inspiratory time)
- PEEP
- PIP
- O₂%

Additional features

- Rise time
- Trigger Sensitivity (Flow or Pressure breath detection threshold)

Alarms thresholds

- High and low PIP
- High and low PEEP
- High RR
- Apnoea time (Can be turned OFF)

Alarms available when flow sensor connected

- High and low Vte
- High and low Vmin
- Percentage leak

Additional items

- Manual breath or Inspiratory hold button

Features with VTV module

- VTV of patient breaths



Features with SpO₂ module

- Pleth waveform when selected
- High and low SpO₂ alarm thresholds
- High and low PR alarm thresholds



OxyGenie® + SpO₂ module

- SpO₂ target range
- High O₂% alarm



Features with etCO₂ module

- etCO₂ waveform when selected
- High and low etCO₂ alarm thresholds



3.4 PSV

Pressure Supported Ventilation

**CORE
V2.0**

This is a pressure limited mode of ventilation in which each breath is patient triggered and supported. The breath is patient triggered, pressure supported and patient terminated. The infant therefore has control of the whole cycle, i.e. the inspiratory time and frequency. This form of ventilation is dependant on the use of a flow sensor placed between the ET tube connector and the patient circuit. Changes in flow or volume signal detects spontaneous breathing.

The termination sensitivity is also user adjustable from 0% - 50%.

User sets the following:-

- RR (Respiratory rate)
- Max Ti (Maximum Inspiratory time.)
- PEEP
- PIP
- O₂%

Additional features

- Rise time
- Trigger Sensitivity (Flow or Pressure breath detection threshold)
- Termination Sensitivity

Alarms thresholds

- High and low PIP
- High and low PEEP
- High RR
- Apnoea time (Can be turned OFF)

Alarms available when flow sensor connected

- High and low Vte
- High and low Vmin
- Percentage leak

Additional items

- Manual breath or Inspiratory hold button

Features with VTV module

- VTV of all breaths



Features with SpO₂ module

- Pleth waveform when selected
- High and low SpO₂ alarm thresholds
- High and low PR alarm thresholds



OxyGenie® + SpO₂ module

- SpO₂ target range
- High O₂% alarm

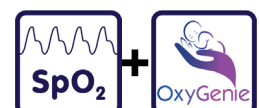

Features with etCO₂ module

- etCO₂ waveform when selected
- High and low etCO₂ alarm thresholds

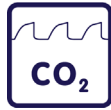
**3.5 SIMV****Synchronised Intermittent Mandatory Ventilation**

The frequency of mandatory breaths is determined by the RR control. When a mandatory breath is due an assist window opens and waits for a patient's inspiratory effort. When this occurs the ventilator delivers a synchronised breath (SIMV breaths). Once the breath has been delivered the assist window closes until the next set breath is due.

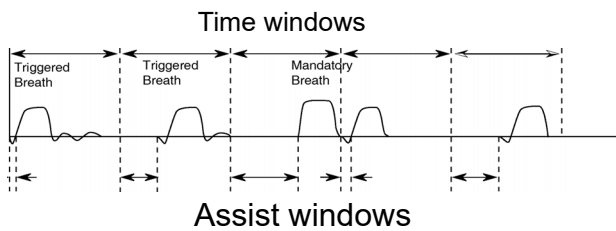

If the ventilator does not see a patient's attempt to breathe before the end of the defined time window then a mandatory breath is delivered. The mandatory breath point is the Time Window minus the Inspiratory Time.

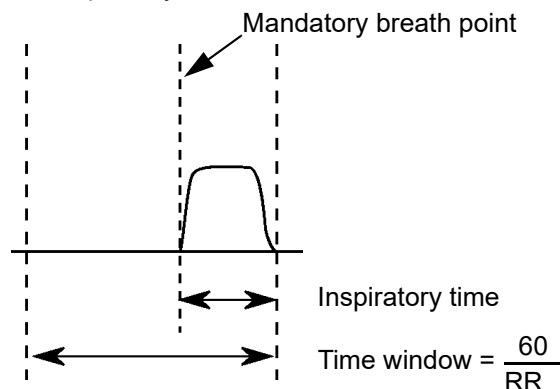
**User sets the following:-**

- RR (Respiratory rate)
- Ti (Inspiratory time)
- PEEP
- PIP
- O₂%

Additional features

- Rise time
- Trigger Sensitivity (Flow or Pressure breath detection threshold) – The patient effort required for the ventilator to recognise the breath.
- Pressure support

Alarms thresholds

- High and low PIP
- High and low PEEP
- High RR
- Apnoea time (Can be turned OFF)

Alarms available when flow sensor connected

- High and low V_te
- High and low V_{min}
- Percentage leak

Features with VTV module

- VTV of all breaths

**Features with SpO₂ module**

- Pleth waveform when selected
- High and low SpO₂ alarm thresholds
- High and low PR alarm thresholds

**OxyGenie® + SpO₂ module**

- SpO₂ target range
- High O₂% alarm

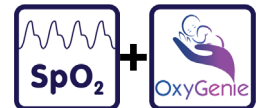
**Features with etCO₂ module**

- etCO₂ waveform when selected
- High and low etCO₂ alarm thresholds



3.6 HFOV

High Frequency Oscillation

In this mode, the ventilator shall deliver continuous high frequency oscillation. There is no patient interaction.



User sets the following:-

- Frequency
- I:E ratio
- MAP
- Delta P
- VTV
- O₂%

Additional features

- Sigh RR
- Sigh Ti
- Sigh P

Alarms thresholds

- High and low Paw

Alarms available when flow sensor connected

- High and low Vte
- High and low Vmin
- Percentage leak

Features with SpO₂ module

- Pleth waveform when selected
- High and low SpO₂ alarm thresholds
- High and low PR alarm thresholds



OxyGenie® + SpO₂ module

- SpO₂ target range
- High O₂% alarm



3.7 HFOV+CMV

A combination of oscillations during the expiratory or inspiratory & expiratory phase of a time cycled, pressure limited breath in CMV mode.



User sets the following:-

- RR (Respiratory rate)
- Ti (Inspiratory time)
- Frequency
- PEEP
- PIP
- Delta P
- O₂%

Additional features

- HFOV activity

Features with SpO₂ module

- Pleth waveform when selected
- High and low SpO₂ alarm thresholds
- High and low PR alarm thresholds



OxyGenie® + SpO₂ module

- SpO₂ target range
- High O₂% alarm

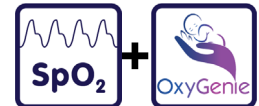

4. Description of the Ventilation Modes (Non Invasive - Dual limb patient circuits)

4.1 nCPAP

Nasal Continuous Positive airway pressure.

**CORE
V2.0**

The ventilator generates a continuous positive airway pressure at a level set by the User.

User sets the following:-

- Ti (Inspiratory time)
- CPAP
- PIP
- O₂%

Additional features

- RR backup
- Rise time
- Trigger Sensitivity Pressure breath detection threshold – The patient effort required for the ventilator to recognise the breath.

Alarms

- High and low PIP
- High and low CPAP
- High RR
- Apnoea time (Can be turned OFF)

Features with SpO₂ module

- Pleth waveform when selected
- High and low SpO₂ alarm thresholds
- High and low PR alarm thresholds



OxyGenie® + SpO₂ module

- SpO₂ target range
- High O₂% alarm

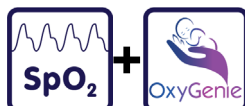

4.2 NIPPV

Non invasive positive pressure ventilation.

**CORE
V2.0**

In this mode the inspiratory cycle is initiated by the ventilator at a set respiratory rate. The breaths are time cycled.

User sets the following:-

- RR (Respiratory rate)
- Ti (Inspiratory time)
- PEEP
- PIP
- O₂%

Additional features

- Rise time

Alarms

- High and low PIP
- High and low PEEP

Additional items

- Manual breath or Inspiratory hold button

Features with SpO₂ module

- Pleth waveform when selected
- High and low SpO₂ alarm thresholds
- High and low PR alarm thresholds



OxyGenie® + SpO₂ module

- SpO₂ target range
- High O₂% alarm



4.3 NIPPV Tr.

Non invasive positive pressure ventilation Triggered



In this mode all the patient's breath attempts are pressure supported. Mechanical breaths are delivered at the set parameters (Ti, PEEP and PIP) if no patient effort is recognized.

User sets the following:-

- RR (Respiratory rate)
- Ti (Inspiratory time)
- PEEP
- PIP
- O₂%

Additional features

- Rise time
- Trigger Sensitivity Pressure breath detection threshold

Alarms

- High and low PIP
- High and low PEEP

Additional items

- Manual breath or Inspiratory hold button

Features with SpO₂ module

- Pleth waveform when selected
- High and low SpO₂ alarm thresholds
- High and low PR alarm thresholds



OxyGenie® + SpO₂ module

- SpO₂ target range
- High O₂% alarm

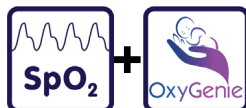

4.4 nHFOV

Nasal high frequency oscillation



In this mode, the ventilator shall deliver continuous high frequency oscillation. There is no patient interaction.

User sets the following:-

- Frequency
- I:E ratio
- MAP
- Delta P
- O₂%

Additional features

- Sigh RR
- Sigh Ti
- Sigh P

Alarms thresholds

- High and low Paw

Additional items

- Sigh button or Sigh Hold

Features with SpO₂ module

- Pleth waveform when selected
- High and low SpO₂ alarm thresholds
- High and low PR alarm thresholds



OxyGenie® + SpO₂ module

- SpO₂ target range
- High O₂% alarm

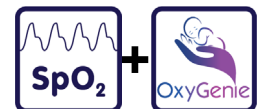

5. Description of the Ventilation Modes (Non Invasive - Single limb patient circuits)

5.1 nCPAP

Nasal Continuous Positive airway pressure.



The ventilator generates a continuous positive airway pressure at a level set by the User.

User sets the following:-

- Ti (Inspiratory time)
- CPAP
- PIP
- O₂%

Additional features

- RR backup
- Rise time
- Trigger Sensitivity Pressure breath detection threshold – The patient effort required for the ventilator to recognise the breath.

Alarms

- High and low PIP
- High and low CPAP
- High RR
- Apnoea time (Can be turned OFF)

Additional items

- Manual breath or Inspiratory hold button

Features with SpO₂ module

- Pleth waveform when selected
- High and low SpO₂ alarm thresholds
- High and low PR alarm thresholds



OxyGenie® + SpO₂ module

- SpO₂ target range
- High O₂% alarm

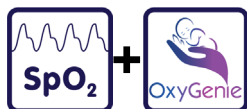

5.2 DuoPAP

Non invasive positive pressure ventilation.



In this mode the inspiratory cycle is initiated by the ventilator at a set respiratory rate. The breaths are time cycled.

User sets the following:-

- RR (Respiratory rate)
- Ti (Inspiratory time)
- PEEP
- PIP
- O₂%

Additional items

- Manual breath or Inspiratory hold button

Features with SpO₂ module

- Pleth waveform when selected
- High and low SpO₂ alarm thresholds
- High and low PR alarm thresholds



OxyGenie® + SpO₂ module

- SpO₂ target range
- High O₂% alarm



6. Description of the Ventilation Modes (Non Invasive - O₂ cannula)

6.1 O₂ therapy

The ventilator generates a continuous flow at a level set by the User.



The User sets the following:-

- Flow
- O₂%

Features with SpO₂ module

- Pleth waveform when selected
- High and low SpO₂ alarm thresholds



OxyGenie® + SpO₂ module

- SpO₂ target range
- High O₂% alarm

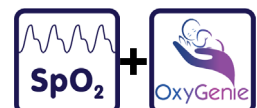

Intended use

“Summary statement” on page 24

“Condition of use” on page 24



7. Intended use of the SLE6000

7.1 Summary statement

The SLE6000 ventilator is intended to provide continuous or intermittent respiratory support for premature neonates greater than 0.3kg, term neonates and infants, as well as paediatric patients up to 30kg depending on condition.

The ventilator is intended for use in either invasive or non-invasive applications. The available ventilator modes and features are configurable to customer requirements such as High Frequency Oscillation, etCO₂ monitoring and SpO₂ monitoring (measuring and monitoring blood oxygen saturation level using the SLE SpO₂ cable) and OxyGenie® a function that automatically adjusts the delivered O₂ to increase time spent in the SpO₂ target range).

The SLE6000 ventilator is intended for use by a physician or authorised qualified medical personnel.

The ventilator is mobile when trolley mounted but intended for static operation in a Professional Healthcare Facility. See section '8. Warnings & Cautions - Ventilator' on page 26 for exclusions.

7.1.1 Medical indication

Any pathology, where optimal gas exchange is compromised and/or where patient condition necessitates respiratory support.

7.1.2 Medical contraindication

There are no known contra-indications to ventilation.

Cautions and warnings in this manual should be adhered to.

Use of OxyGenie® is contraindicated on patients whose target SpO₂ is outside the following target ranges.

90-94%
91-95%
92-96%
94-98%

7.1.3 Patient type

The SLE6000 series ventilator is intended to be used on neonatal through paediatric patients with weight ranging from 0.3 to 30 kg and dependent on lung condition.

7.1.4 Body part under treatment

The ventilator is designed to administer ventilation to the patient's respiratory system.

7.1.5 Clinical therapy

The SLE 6000 is used in conventional or High Frequency Oscillation modes of ventilation for:

- Non-life support ventilation
- Life support ventilation (needs Vte or etCO₂ measurement)
- Non-invasive and invasive ventilation

Indications for the need for mechanical ventilation include:

- Prematurity
- Birth Asphyxia
- Respiratory Distress Syndrome
- Congenital abnormalities
- Infection
- Multiple birth (infants normally premature)
- Gastro intestinal conditions
- Meconium Aspiration Syndrome
- Central Nervous System problems
- Persistent Pulmonary Hypertension
- Hypoxia that does not improve with continuous airway pressure

7.1.6 Main User Profile

The SLE 6000 is intended to be used in clinical application only by appropriately trained medical personnel and operated only by trained technicians during maintenance and service.

7.2 Condition of use

The SLE6000 ventilator is intended to provide continuous or intermittent respiratory support for premature and term neonates, infants, and paediatric patients depending on condition. The ventilator is mobile when trolley mounted but intended for static operation in a hospital intensive care unit in normal use.

The ventilator is intended for use within an appropriate medically clean environment, with medical grade Air and Oxygen and with appropriate MEDICALLY CLEAN ventilator breathing system and accessories.

Warnings and cautions

“Warnings & Cautions - Ventilator” on page 26

“Warnings & Cautions - External sensors” on page 29



8. Warnings & Cautions - Ventilator

8.1 Warnings - general

The following warnings must be read and understood before using the ventilator. Failure to do so could lead to injury or death of the patient.

- 1 The whole of this manual should be read and understood before using the ventilator. Operators must be suitably trained and clinically authorized for using the ventilator with patients. Particular care should be taken to check the ventilator pressures prior to changing modes.
- 2 Oxygen - Clinical use. Oxygen is a drug and should be prescribed as such.
- 3 Oxygen - Fire Hazard. Oxygen vigorously supports combustion and its use requires special precaution to avoid fire hazards. Keep all sources of ignition away when oxygen is in use. Do not use oil or grease on oxygen fittings or where oxygen is used.
- 4 Check the condition of the gas supply hoses to the ventilator. Do not use any hose that shows signs of cracking, abrasion, kinking, splits, excessive wear or ageing. Make sure that the Air or O₂ hose has not come into contact with oil or grease.
- 5 When the ventilator is being used on a patient, a suitably trained person must be in attendance at all times to take prompt action should an alarm or other indication of a problem occur.
- 6 Do not enter the "Standby" mode when connected to a patient. No ventilation is delivered.
- 7 In case of ventilator failure, the lack of immediate access to appropriate alternative means of ventilation can result in patient death.
- 8 Do not touch the patient and ventilator metalwork at the same time to avoid earthing the patient.
- 9 The ventilator shall not be used in a hyperbaric chamber.
- 10 The ventilator shall not be used in a MRI (Magnetic Resonance Imaging) scanner.
- 11 The ventilator shall not be used with helium or mixtures with helium.
- 12 The ventilator accuracy can be affected by the gas added by use of a nebuliser.
- 13 Any computer connected to the ventilator must be specified for medical use.
- 14 The VGA port shall not be used when connected to a patient. It is for training purposes only.
- 15 The ventilator does not use Latex, nor was it used in its construction.
- 16 Disconnect the mains power supply from the ventilator prior to cleaning.
- 17 Do not cover the ventilator during use or allow the ventilator to become covered by any fabric or curtain. Do not allow the exhaust ports or inlet vents to become obstructed or blocked by positioning the ventilator near curtains or fabric.
- 18 The ventilator has no emergency air intake.
- 19 In a "Mains Power Fail" condition and if the user clears the "Mains Power Fail" alarm, the next power related alarm that will trigger will be the medium priority "Battery Low" alarm. This indicates that the internal power supply has reached 25% capacity. If the user clears the medium priority "Mains Power Fail" alarm, the next power related alarm that will trigger will be the high priority "Battery Low" alarm. This indicates that the internal power supply has a less than 10 minutes remaining battery life. The user shall remove the patient to an alternative form of ventilation at this point if mains power cannot be restored.
- 20 Do not allow the batteries to remain in a deep discharged state. Recharge the batteries as soon as possible to preserve battery life. If the ventilator is to be placed in storage then ensure the batteries are fully charged.
- 21 When the ventilator is used without the flow sensor and ventilating a patient with a 3mm or smaller size endotracheal tubes, in the case of patient extubation or the ET tube disconnecting from its ET connector, only the monitoring of flow, or of SpO₂, or of transcutaneous Oxygen and Carbon Dioxide will dependably alert the medical team to an alarm situation, not the monitoring of pressures.
- 22 Failure to comply with the recommended service programs could lead to injury of the patient, operator or damage to the ventilator. It is the owners responsibility to ensure that the equipment is regularly maintained.
- 23 To avoid the risk of electric shock, this equipment must only be connected to a supply mains with protective earth.
- 24 The ventilator must not be started or used on battery power alone.

- 25 If the ventilator is adversely affected by equipment emitting electromagnetic interference then that equipment should be switched off or removed from the vicinity. Conversely, if the ventilator is the source of interference to other neighbouring equipment, it should be switched off or taken to another location.
- 26 The functioning of this machine may be adversely affected by the operation of equipment such as high frequency surgical (diathermy) equipment, defibrillators, mobile phones or short-wave therapy equipment in the vicinity.
- 27 The equipment is not suitable for use with, or in the presence of flammable anaesthetic mixtures.
- 28 Do not clean the touchscreen whilst the ventilator is in operation.
- 29 No modification of the ventilator is allowed. Any modification of the ventilator or system requires evaluation to BS EN 60601-1. (Please contact SLE if you require modification of the ventilator or the system).
- 30 The ventilator shall only be used with SLE approved accessories.
- 31 The RS232 port shall not be connected to an IT network.
- 32 USB data devices shall not be connected to the data port during patient use.
- 33 Only the Aerogen USB controller shall be connected to the rear mounted USB port marked Aerogen USB controller.
- 34 Ensure that the ventilator is not positioned in such a way that it is difficult to operate the disconnection device.
- 35 When the air or oxygen supplies are known to contain moisture and the ventilator is to be used continuously the user is required to check the rear mounted water traps at regular intervals.
- 36 The user needs to be aware that SLE6000 ventilator alarms can be configured to user defined presets. This can lead to units within a single locale having different alarm presets.

8.2 Warnings - EMC

- 1 Use of this equipment adjacent to or stacked with other equipment should be avoided because it could result in improper operation. If such use is necessary, this equipment and the other equipment should be observed to verify that they are operating normally.

- 2 Use of accessories, transducers and cables other than those specified or provided by the manufacturer of this equipment could result in increased electromagnetic emissions or decreased electromagnetic immunity of this equipment and result in improper operation.
- 3 Portable RF communications equipment (including peripherals such as antenna cables and external antennas) should be used no closer than 30 cm (12 inches) to any part of the SLE6000, including cables specified by the manufacturer. Otherwise, degradation of the performance of this equipment could result.

8.3 Cautions - EMC

Only use the cables listed in chapter '47. Consumables & Accessories' on page 280 for connection to accessories or transducers.

8.4 Warnings - patient circuit & humidifier

- 4 Use only SLE approved patient circuits. The accuracy of controlled and measured parameters is only guaranteed by use of the approved circuits.
- 5 On no account should antistatic or electrically conductive tubing be used.
- 6 The humidifier used in the patient circuit must be operated and maintained in accordance with the manufacturer's instructions.
- 7 Any water trap used in the patient circuit must be held in the upright positions below the patient and drained regularly before it is full.
- 8 The patient circuit should not be modified other than the way described for non invasive use. Modified patient circuits or circuits with additional sections or components may produce too high a circuit resistance and circuit compliance for effective ventilation.
- 9 Do not allow the heated section of the patient circuit to come into contact with the patient.
- 10 Adding attachments or other components or sub-assemblies to the ventilator breathing system can change the pressure gradient across the ventilator breathing system and that such changes to the ventilator breathing system can adversely affect the ventilator performance.
- 11 Nebulisation or humidification can increase the resistance of breathing system filters and that the operator needs to monitor the breathing system filter frequently for increased resistance and blockage.

- 12 Do not allow heated section of the patient circuit to become covered, i.e. by a blanket or covering.
- 13 Do not touch the humidifier hot plate if exposed, as it may burn the skin when hot.
- 14 Ensure the temperature probes are cleaned and sterilized as per the manufacturers instructions.

8.5 Warnings - nCPAP (single Limb)

- 1 When using Small or Extra Small nasal prongs during CPAP, the Ventilator may not raise an alarm if a patient disconnection occurs. It is recommended that back-up breaths are always turned on as this will deliver back up breaths and alert the user to a low PIP condition if the nasal prongs become detached. Only the monitoring of SpO₂, or of transcutaneous Oxygen and Carbon Dioxide will dependably alert the medical team to a patient disconnection.

8.6 Warnings - clinical

- 1 Failure to take corrective action when the alarms are activated could result in injury or death to the patient.
- 2 Use of the nurse call function does not remove the need to monitor both the patient or ventilator at regular intervals.

8.6.1 Monitoring

The minimum bedside patient monitoring requirements are:

- ECG/heart rate.
- Blood pressure.
- Respiratory rate.
- Oxygen saturation.

If the bedside patient monitor cannot provide blood pressure and oxygen saturation monitoring then independent blood pressure and oxygen saturation monitoring shall be used - if available Sp₂O monitoring on the ventilator can be used.

Additional monitoring HFOV and non invasive ventilation

- Transcutaneous carbon dioxide monitoring.

Additional monitoring conventional invasive modes

- Transcutaneous carbon dioxide monitoring or etCO₂ monitoring

For units that are without Transcutaneous carbon dioxide monitoring or etCO₂ monitoring facilities for arterial / venous or capillary blood sampling must be available.

8.6.2 Clinical - invasive

- 1 When switching from conventional to high-frequency ventilation, or vice-versa, alterations in ventilator settings and inspired oxygen concentrations may be required.

- 2 All ventilation should only be initiated by fully trained and experienced medical personnel.
- 3 Incorrect humidification; could cause mobilisation of secretions and airway blockage.
- 4 Intra-ventricular haemorrhage, cerebral ischaemia due to increased levels of carbon dioxide.
- 5 Volutrauma resulting in (bronchopulmonary dysplasia in the newborn);
- 6 The use of an uncuffed ET tube causing leaks preventing oxygenation and ventilation.
- 7 Maintenance of an adequate airway is of paramount importance.

8.6.3 Clinical - non invasive

- 1 Damage to nares.
- 2 Under- or over- ventilatory support (with consequent abnormalities in blood gases);
- 3 Incorrect humidification; could cause mobilisation of secretions and airway blockage.
- 4 Damage to trachea and bronchi;
- 5 Over- or under- inflation of the lung;
- 6 Atelectasis;
- 7 Air leak syndrome (pneumothorax, pneumomediastinum, pneumopericardium, pulmonary interstitial emphysema).

8.7 Cautions - general

- 1 During use apart from the flow sensor there are no serviceable ventilator items.
- 2 The ventilator should be disposed of in accordance to the local WEEE (Waste Electrical and Electronic Equipment) guidelines.
- 3 Do not use solvent based cleaning solutions to clean the touchscreen or covers.
- 4 Do not use a sharp instrument, such as a pen to activate the controls as the excessive pressure applied by the point will damage the touchscreen membrane.
- 5 The ventilator contains temperature dependant devices which perform normally in controlled environments in hospitals. However if the ventilator has been stored at a temperature different to that in which it will be used, allow the unit to acclimatize before powering up. (Operating temperature range +10°C to +40°C)
- 6 Disposal of the Oxygen cell should be in accordance with local regulations for hazardous substances. Do not incinerate. SLE offers a cell disposal service.

- 7 Care should be taken when attaching other equipment as this may affect mechanical stability.
- 8 When using the SLE6000 in conjunction with either the SLE500E or SLE500S medical air compressors the user needs to be aware that the HFOV performance is limited. The SLE500E or SLE500S medical air compressors maximum flow is 60 l/min the SLE6000 requires 85 l/min. This disparity will only be evident in HFOV mode where Delta P pressures of greater than 150 mbar will cause the MAP (mean airway pressure) to be unstable.

8.7.1 Bacterial filters

- 1 The use of bacterial filters between the fresh gas port and humidifier supply line & exhalation block and the expiratory supply line is recommended.

8.7.2 Flow sensor

- 1 The reusable and single use flow sensor are serviceable items and may require cleaning during use.

8.8 Cautions - clinical

- 1 Avoid setting the alarm limits to their extreme values as this can limit the ventilators ability to detect hazardous conditions.

9. Warnings & Cautions - External sensors



9.1 Warnings for Masimo SET®

- 1 Explosion hazard. Do not use the pulse oximeter in the presence of flammable anesthetics or other flammable substance in combination with air, oxygen-enriched environments, or nitrous oxide.
- 2 A pulse oximeter should NOT be used as an apnoea monitor.
- 3 Do not start or operate the pulse oximeter unless the setup was verified to be correct.
- 4 Do not use the pulse oximeter if it appears or is suspected to be damaged.
- 5 To ensure safety, avoid stacking multiple devices or placing anything on the device during operation.
- 6 Pulse rate measurement is based on the optical detection of a peripheral flow pulse and therefore may not detect certain arrhythmias. The pulse oximeter should not be used as a replacement or substitute for ECG based arrhythmia analysis.
- 7 A pulse oximeter should be considered an early warning device. As a trend towards patient deoxygenation is indicated, blood samples should be analyzed by a laboratory co-oximeter to completely understand the patient's condition.
- 8 If an alarm condition (other than exceptions listed herein) occurs while the alarm silence period is set to off, the only alarm indications will be visual displays and symbols related to the alarm condition.
- 9 To protect from electric shock, always remove the sensor and completely disconnect the pulse oximeter before bathing the patient.
- 10 Measure the oximeter's leakage current whenever an external device is connected to the serial port. Leakage current must not exceed 100 microamperes.
- 11 Do not place the pulse oximeter or accessories in any position that might cause it to fall on the patient.
- 12 Do not use extension cords or adaptors of any type. The power cord and plug must be intact and undamaged.
- 13 If there is any doubt about the integrity of the protective earth conductor arrangement, operate the oximeter on internal battery power until the

AC power supply protective conductor is fully functional.

- 14 To ensure patient electrical isolation, connect only to other equipment with electronically isolated circuits.
- 15 As with all medical equipment, carefully route patient cabling to reduce the possibility of patient entanglement or strangulation.
- 16 Interfering Substances: Carboxyhemoglobin may erroneously increase readings. The level of increase is approximately equal to the amount of carboxyhemoglobin present. Dyes, or any substance containing dyes, that change usual arterial pigmentation may cause erroneous readings.
- 17 Do not use the pulse oximeter or Masimo oximetry sensors during magnetic resonance imaging (MRI) scanning. Induced current could potentially cause burns. The pulse oximeter may affect the MRI image, and the MRI unit may affect the accuracy of the oximetry measurements.
- 18 RS-232 System Interconnection. Consult IEC-601-1-1 for system interconnection guidance. The specific requirements for system interconnection are dependent upon the device connected to the pulse oximeter and the relative locations of each device from the patient, and the relative location of the connected device to the medically used room containing the pulse oximeter. In all circumstance the pulse oximeter must be connected to a grounded AC power supply. The pulse oximeter is referred to as an IEC 601/F device in the summary of situations table contained in IEC 601-1-1.

9.2 Cautions for Masimo SET®

9.2.1 General

- 1 Do not place the pulse oximeter where the controls can be changed by the patient.
- 2 When patients are undergoing photodynamic therapy they may be sensitive to light sources. Pulse oximetry may be used only under careful clinical supervision for short time periods to minimize interference with photodynamic therapy.
- 3 Do not place the pulse oximeter on electrical equipment that may affect the device, preventing it from working properly.
- 4 Change the application site or replace the sensor and/or patient cable when a “Replace sensor” and/or “Replace patient cable”, or a persistent poor signal quality message (such as “Low SIQ”) is displayed on the host monitor. These messages may indicate that patient monitoring time is exhausted on the patient cable or sensor.
- 5 If using pulse oximetry during full body irradiation, keep the sensor out of the radiation field. If the sensor is exposed to the radiation, the reading might be inaccurate or the device might read zero for the duration of the active irradiation period.
- 6 Electrical Shock Hazard: Carry out periodic tests to verify that leakage currents of patient-applied circuits and the system are within acceptable limits as specified by the applicable safety standards. The summation of leakage currents must be checked and in compliance with IEC 60601-1 and UL60601-1. The system leakage current must be checked when connecting external equipment to the system. When an event such as a component drop of approximately 1 meter or greater or a spillage of blood or other liquids occurs, retest before further use. Injury to personnel could occur.
- 7 Disposal of product - Comply with local laws in the disposal of the device and/or its accessories.
- 8 To minimize radio interference, other electrical equipment that emits radio frequency transmissions should not be in close proximity to the pulse oximeter.
- 9 Do not loop the patient cabling into a tight coil or wrap around the device, as this can damage the patient cabling.

- 10 Additional information specific to the Masimo sensors compatible with the pulse oximeter, including information about parameter/ measurement performance during motion and low perfusion, may be found in the sensor's directions for use (DFU).
- 11 Cables and sensors are provided with X-Cal™ technology to minimize the risk of inaccurate readings and unanticipated loss of patient monitoring. Refer to the Cable or Sensor DFU for the specified duration of the patient monitoring time.
- 12 Do not adjust, repair, open, disassemble, or modify the pulse oximeter or accessories. Injury to personnel or equipment damage could occur.

9.2.2 Cleaning

- 1 Use cleaning solutions only as instructed in this operator's manual.
- 2 Electrical shock and flammability hazard: Before cleaning, always turn off the device and disconnect from any power source.
- 3 Do not submerge the pulse oximeter in any cleaning solution or attempt to sterilize by autoclave, irradiation, steam, gas, ethylene oxide or any other method. This will seriously damage the pulse oximeter.
- 4 Do not soak or immerse the monitor in any liquid.
- 5 Use the cleaning solution sparingly. Excessive solution can flow into the monitor and cause damage to internal components.
- 6 Do not attempt to clean the device while monitoring a patient.
- 7 Do not touch, press, or rub the display panels with abrasive cleaning compounds, instruments, brushes, rough surface materials, or bring them into contact with anything that could scratch the panel.
- 8 Do not use petroleum-based or acetone solutions, or other harsh solvents, to clean the oximeter. These substances attack the device's materials and device failure can result.

9.2.3 Cautions for alarms

- 1 Check alarm limits each time the pulse oximeter is used to ensure that they are appropriate for the patient being monitored.

9.2.4 Cautions for measurements

Variation in measurements may be profound and may be affected by sampling technique as well as the patient's physiological conditions. Any results exhibiting inconsistency with the patient's clinical status should be repeated and/or supplemented with additional test data. Blood samples should be analyzed by laboratory instruments prior to clinical decision making to completely understand the patient's condition.

The pulse oximeter should not be used as the sole basis for medical decisions. It must be used in conjunction with clinical signs and symptoms.

If the accuracy of any measurement does not seem reasonable, first check the patient's vital signs by alternate means and then check the pulse oximeter for proper functioning.

Inaccurate measurements may be caused by:

- 1 Incorrect sensor application or use
- 2 Significant levels of dysfunctional hemoglobins. (e.g., carboxyhemoglobin or methemoglobin)
- 3 Intravascular dyes such as indocyanine green or methylene blue.
- 4 Interfering Substances: Dyes, Nail polish or any substance containing dyes, that change usual blood pigmentation may cause erroneous readings.
- 5 Pulse rate measurement is based on the optical detection of a peripheral flow pulse and therefore may not detect certain arrhythmias. The pulse oximeter should not be used as a replacement or substitute for ECG based arrhythmia analysis.
- 6 Exposure to excessive illumination, such as surgical lamps (especially ones with a xenon light source),
- 7 Bilirubin lamps, fluorescent lights, infrared heating lamps, or direct sunlight (exposure to excessive illumination can be corrected by covering the sensor with a dark or opaque material)
- 8 Excessive patient movement.
- 9 SpO₂ is empirically calibrated to functional arterial oxygen saturation in healthy adult volunteers with normal levels of carboxyhemoglobin (COHb) and methemoglobin (MetHb). A pulse oximeter cannot measure elevated levels of COHb or MetHb. Increases in either COHb or MetHb will affect the accuracy of the SpO₂ measurement.

For increased COHb: COHb levels above normal tend to increase the level of SpO₂. The level of increase is approximately equal to the amount of COHb that is present.

NOTE: High levels of COHb may occur with a seemingly normal SpO₂. When elevated levels of COHb are suspected, laboratory analysis (CO-Oximetry) of a blood sample should be performed.

- 10 For increased MethHb: the SpO₂ may be decreased by levels of MethHb of up to approximately 10% to 15%. At higher levels of MethHb, the SpO₂ may tend to read in the low to mid 80s. When elevated levels of MethHb are suspected, laboratory analysis (CO-Oximetry) of a blood sample should be performed.
- 11 Venous congestion may cause under reading of actual arterial oxygen saturation. Therefore, assure proper venous outflow from monitored site. Sensor should not be below heart level (e.g. sensor on hand of a patient in a bed with arm dangling to the floor).
- 12 Venous pulsations may cause erroneous low readings (e.g. tricuspid valve regurgitation).
- 13 Patient suffers from abnormal pulse rhythm.
- 14 The pulsations from intra-aortic balloon support can be additive to the pulse rate on the oximeter pulse rate display. Verify patient's pulse rate against the ECG heart rate.
- 15 Use only Masimo approved accessories.
- 16 Motion artifact may lead to inaccurate measurements.
- 17 Elevated levels of Total Bilirubin may lead to inaccurate SpO₂ measurements.
- 18 With very low perfusion at the monitored site, the readings may read lower than core arterial oxygen saturation.
- 19 If the Low Perfusion message is frequently displayed, find a better perfused monitoring site. In the interim, assess the patient and, if indicated, verify oxygenation status through other means.
- 20 Do not expose the Pulse CO-Oximeter to excessive moisture such as direct exposure to rain.
- 21 Excessive moisture can cause the Pulse CO-Oximeter to perform inaccurately or fail.
- 22 Do not immerse the sensor or patient cable in water or, solvents, or cleaning solutions (The sensors and connectors are not waterproof).

- 23 Placement of a sensor on an extremity with a blood pressure cuff, arterial catheter, or intravascular line.
- 24 If SpO₂ values indicate hypoxemia, a laboratory blood sample should be taken to confirm the patient's condition.
- 25 A functional tester cannot be used to assess the accuracy of the pulse oximeter.
- 26 High-intensity extreme lights (such as pulsating strobe lights) directed on the sensor, may not allow the pulse oximeter to obtain vital sign readings.
- 27 When using the Maximum Sensitivity setting, performance of the "Sensor Off" detection may be compromised. If the device is in this setting and the sensor becomes dislodged from the patient, the potential for false readings may occur due to environmental "noise" such as light, vibration, and excessive air movement.
- 28 Loss of pulse signal can occur in any of the following situation:
 - The sensor is too tight.
 - There is excessive illumination from light sources such as a surgical lamp, a bilirubin lamp, or sunlight.
 - A blood pressure cuff is inflated on the same extremity as the one with a SpO₂ sensor attached.
 - The patient has hypotension, severe vasoconstriction, severe anemia, or hypothermia.
 - There is arterial occlusion proximal to the sensor.
 - The patient is in cardiac arrest or is in shock.
- 29 The pulse oximeter may be used during electrocautery, but this may affect the accuracy or availability of the parameters and measurements.
- 30 Sensors applied too tightly or that become tight due to edema will cause inaccurate readings and can cause pressure necrosis.

9.2.5 Cautions for Masimo sensors

- 1 Before use, carefully read the sensor directions for use.
- 2 Use only Masimo oximetry sensors for SpO₂ measurements. Other oxygen transducers (sensors) may cause improper MS board performance.

- 3 Tissue damage can be caused by incorrect application or use (for example by wrapping the sensor too tightly). Inspect the sensor site as directed in the sensor Directions for Use to ensure skin integrity and correct positioning and adhesion of the sensor.
- 4 Do not use damaged sensors. Do not use any sensor with exposed optical components.
- 5 Do not immerse the sensor in water, solvents, or cleaning solutions (the sensors and connectors are not waterproof). Do not sterilize by irradiation, steam, or ethylene oxide. See the cleaning instructions in the directions for use for reusable Masimo sensors.
- 6 Do not use damaged patient cables. Do not immerse the patient cables in water, solvents, or cleaning solutions (the patient cable connectors are not waterproof). Do not sterilize by irradiation, steam, or ethylene oxide. See the cleaning instructions in the directions for use for reusable Masimo patient cables.



9.3 Warnings for Oridion Micropod™

- 1 If uncertain about the accuracy of any measurement, first check the patient's vital signs by alternate means, and then make sure the module is functioning correctly.
- 2 The module should not be used as an apnoea monitor.
- 3 To ensure patient safety, do not place the module in any position that might cause it to fall on the patient.
- 4 Carefully route the FilterLine™ to reduce the possibility of patient entanglement or strangulation.
- 5 Check CO₂ and O₂ tubing regularly during use to ensure that no kinks are present. Kinked tubing may cause inaccurate CO₂ sampling or affect O₂ delivery to patient.
- 6 Do not lift the module by the FilterLine™, as the FilterLine™ could disconnect from the module, causing the module to fall on the patient.
- 7 Do not pull the module so that it becomes detached from the patient monitor. After readjusting the position of the module for any reason, ensure that it has not become detached from the monitor.
- 8 To ensure accurate performance and prevent device failure, do not expose the module to extreme moisture, such as rain.
- 9 The use of accessories and cables other than those specified may result in increased emission and/or decreased immunity of the equipment and/or system.
- 10 CO₂ readings and respiratory rate can be affected by certain ambient environmental conditions, and certain patient conditions.
- 11 The module is a prescription device and is to be operated by qualified healthcare personnel only.
- 12 If calibration does not take place as instructed, the module may be out of calibration. A module that is out of calibration may provide inaccurate results.
- 13 Do not use the FilterLine™ H Set Infant/Neonatal during magnetic resonance imaging (MRI) scanning. Using the FilterLine™ H Set Infant/Neonatal during MRI scanning could create an artefact on the MRI image.
- 14 Do not silence the audible alarm on the monitor if patient safety may be compromised.

-
- 15 Always respond immediately to a system alarm since the patient may not be monitored during certain alarm conditions.
 - 16 Before each use, verify that the alarm limits are appropriate for the patient being monitored.
 - 17 When using the MicroPod™ with anesthetics, nitrous oxide or high concentrations of oxygen, connect the gas outlet to a scavenger system.
 - 18 The MicroPod™ is not suitable for use in the presence of flammable anesthetic mixture with air, oxygen or nitrous oxide.
 - 19 The FilterLine™ may ignite in the presence of O₂ when directly exposed to laser, ESU devices, or high heat. When performing head and neck procedures involving laser, electrosurgical devices or high heat, use with caution to prevent flammability of the FilterLine™ or surrounding surgical drapes.
 - 20 To protect against electric shock hazard, the module cover is to be removed only by qualified service personnel. There are no user-serviceable parts inside.
 - 21 To ensure patient electrical isolation, connect only to other equipment with circuits that are electrically isolated.
 - 22 Operating high frequency electrosurgical equipment in the vicinity of the module can produce interference in the module and cause incorrect measurements.
 - 23 Do not use the module with nuclear spin tomography (MRT, NMR, NMT) as the function of the module may be disturbed.
 - 24 Do not modify this equipment without authorization of the manufacturer.
 - 25 If this equipment is modified, appropriate inspection and testing must be conducted to ensure continued safe use of the equipment.
 - 26 When using a sampling line for intubated patients with a closed suction system, do not place the airway adaptor between the suction catheter and endotracheal tube. This is to ensure that the airway adaptor does not interfere with the functioning of the suction catheter.
 - 27 Loose or damaged connections may compromise ventilation or cause an inaccurate measurement of respiratory gases. Securely connect all components and check connections for leaks according to standard clinical procedures.
 - 28 Do not cut or remove any part of the sample line. Cutting the sample line could lead to erroneous readings.
 - 29 Do not use compressed air to clean the FilterLine™.
 - 30 If too much moisture enters the sampling line (i.e., from patient secretions), the message Clearing FilterLine™ will appear in the message area. If the sampling line cannot be cleared, the message FilterLine™ Blockage will appear in the message area. Replace the sampling line once the FilterLine™ Blockage message appears.
- 9.4 Cautions for Oridion Micropod™**
- 1 If the MicroPod™ sustains structural damage so that its internal components are visible, it should not be used.
 - 2 An extension cable should not be used with the USB version or either RS-232 version of the MicroPod™.
 - 3 Caution: Exercise care when removing the MicroPod™ from a mount so that your finger does not get caught in the clip during removal.
 - 4 During MRI scanning, the module must be placed outside the MRI suite. When the module is used outside the MRI suite, etCO₂ monitoring can be implemented using the FilterLine™ XL.
 - 5 In high-altitude environments, etCO₂ values may be lower than values observed at sea level, as described by Dalton's law of partial pressures. When using the module in high-altitude environments, it is advisable to take this into account and to consider adjusting etCO₂ alarm settings accordingly.
 - 6 Electrical installation of the room or the building in which the module is to be used must comply with regulations specified by the country in which the equipment is to be used.
 - 7 A strong magnetic field located 1 cm or less from the MicroPod™ may temporarily affect performance of the MicroPod™.
 - 8 Microstream™ etCO₂ sampling lines are designed for single patient use, and are not to be reprocessed. Do not attempt to clean, disinfect, sterilize or flush any part of the sampling line as this can lead to damage to the module.
 - 9 Dispose of sampling lines and packaging according to standard operating procedures or local regulations for the disposal of contaminated medical waste.
 - 10 Before use, carefully read the Microstream™ etCO₂ sampling lines Directions for Use.
 - 11 Only use Microstream™ etCO₂ sampling lines to ensure the monitor functions properly.
-

- 12 Ensure that tubing is not stretched during use.
- 13 Use of a CO₂ sampling line with H in its name (indicating that it is for use in humidified environments) during MRI scanning may cause interference. These sampling lines include CapnoLine H/Long, CapnoLine H O₂, Smart CapnoLine H/Long, Smart CapnoLine H O₂, and Smart CapnoLine H Plus O₂/Long. The use of non H sampling lines is advised.
- 14 CO₂ sampling lines used with the monitor are marked with the upper limit of oxygen that may be provided with the sampling line. At levels of oxygen provision higher than those marked on the sampling line packaging, dilution of CO₂ readings may occur, leading to lower CO₂ values.
- 15 When monitoring with capnography during sedation, please note that sedation may cause hypoventilation and CO₂ waveform distortion or disappearance. Waveform attenuation or disappearance is an indicator that the status of the patient's airway should be assessed.
- 16 When monitoring patients during upper endoscopy, partial blockage of the oral airway due to endoscope positioning may cause periods of low readings and rounded waveforms. The occurrence will be more pronounced with high oxygen delivery levels.
- 17 If CO₂ insufflation is performed during CO₂ monitoring, the EtCO₂ values will accordingly rise very significantly and this may result in device alarms and abnormally high waveforms until the CO₂ is evacuated from the patient.

10. Warnings & Cautions - OxyGenie®

10.1 Warnings for OxyGenie®

- 1 Do not use OxyGenie® if the difference between SpO₂ and SaO₂ is greater than 5%.

10.2 Cautions for OxyGenie®

- 1 An increasing requirement for oxygen while using OxyGenie® may be indicative of an underlying condition which has to be addressed, even if SpO₂ is within the target range.
- 2 Before initiating (or re initiating) OxyGenie, check (and adjust if necessary) that the O₂ setting is appropriate for the patients current clinical condition. This initial O₂ setting optimises the initial response and initial response time of the algorithm.
- 3 Additional ventilator independent patient monitoring (bedside vital monitoring blood gas analyser) should be performed - if available Sp₂O monitoring on the ventilator can be used.

10.3 Clinical warnings

- 1 Use of OxyGenie® is contraindicated on patients whose target SpO₂ is outside the following target ranges. 90-94%, 91-95%, 92-96%, 94-98%.

This page is intentionally left blank.

Ventilator layout



11. Ventilator layout

This section details the physical features of a SLE6000 infant ventilator.

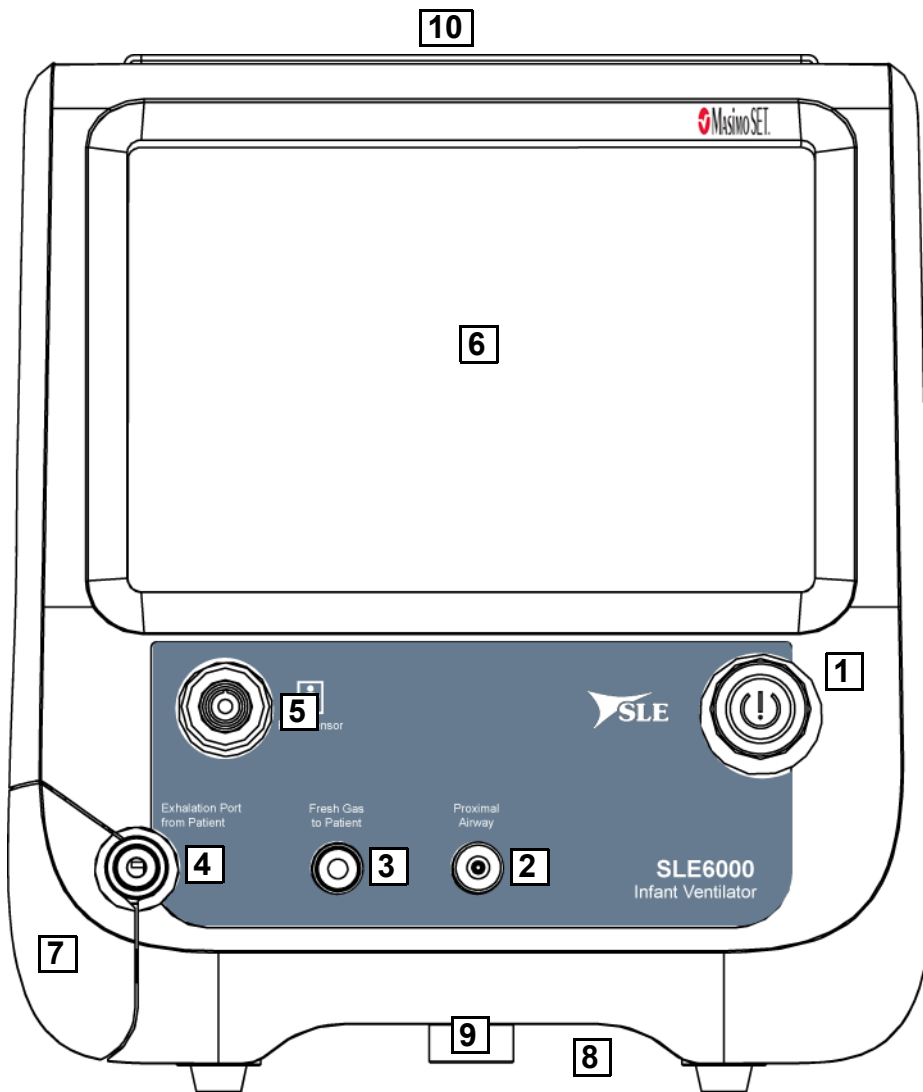

11.1 Front

- 1 Mains power button (Ventilator On/Off control)
- 2 Proximal airway port (Pressure monitor port)
- 3 Fresh gas to patient port
- 4 Exhalation port from patient
- 5 Flow sensor (Electrical connector)
- 6 Touch screen
- 7 Exhalation block cover
- 8 Front lifting point
- 9 Trolley securing point
- 10 Light bar

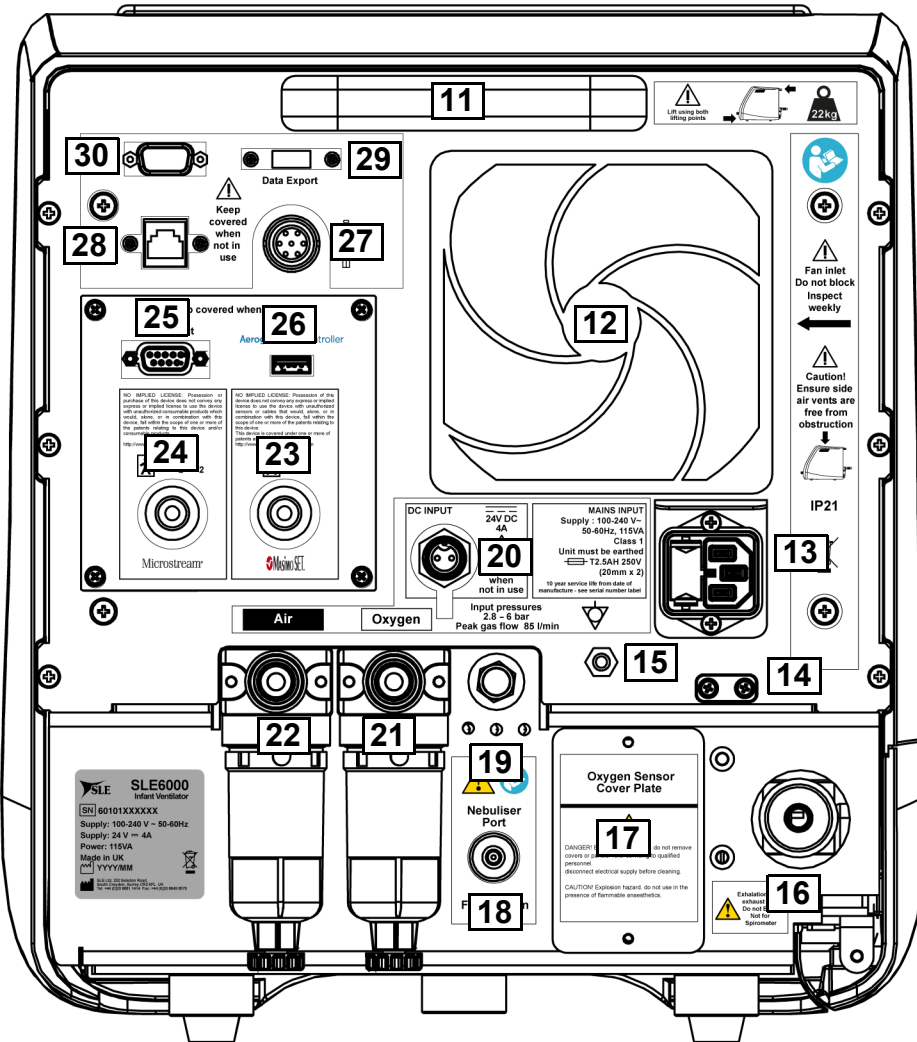

11.2 Rear

- 11 Rear carry handle
- 12 Main cooling fan and filter
- 13 IEC mains inlet socket
- 14 Mains inlet cable locking clamp
- 15 Equipotential stud
- 16 Exhaust port
- 17 Oxygen cell cover plate
- 18 Nebuliser port
- 19 Pressure relief valve and exhaust ports.
- 20 24V DC input electrical connector
- 21 Oxygen inlet port and water trap (Optional)
- 22 Air inlet port and water trap
- 23 SpO₂ electrical connector

- 24 EtCO₂ electrical connector
- 25 RS232 interface (9 way D-sub)
- 26 Aerogen Nebuliser power connector (USB)
- 27 Nurse call electrical connector
- 28 Ethernet interface (RJ-45)
- 29 Data port (USB)
- 30 VGA or DisplayPort output connector

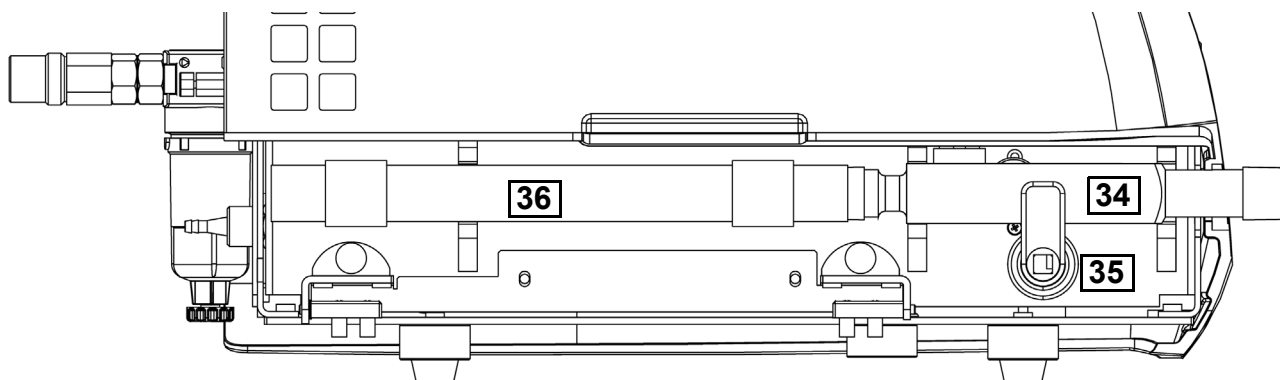
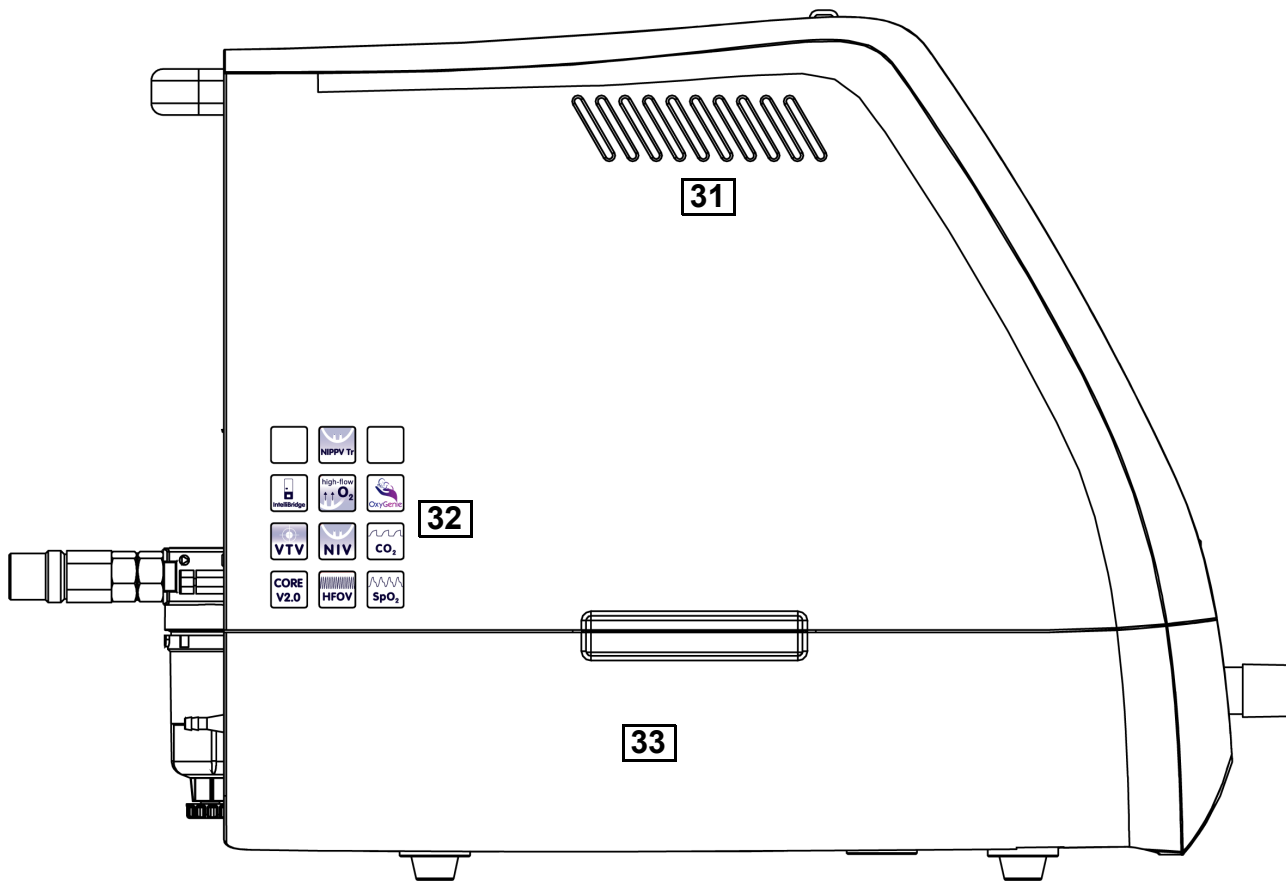

- 31 Air vent (Exhaust)
- 32 Software option ID stickers
- 33 Exhalation block flap
- 34 Exhalation block
- 35 Exhalation block clamp
- 36 Silencer

Ventilator setup

- “Pre-use Inspection” on page 42
- “Connection of equipotential bonding cable” on page 42
 - “Connection of mains power” on page 42
 - “Connection of 24V DC auxiliary power” on page 42
- “Fitting the silencer and exhalation block” on page 43
 - “Gas connections” on page 43
- “Turning the ventilator On” on page 44



12. Ventilator basic setup

This section details the setup of an in-service SLE6000 infant ventilator.

12.1 Pre-use Inspection

A. Check that the water trap/s are empty.

Caution. If the water trap/s are fitted with the manual drain plug and contain water, manually drain the water before proceeding with the setup.

B. Check that the rear fan filter is free from dust.

Note: If the filter is dirty please follow the cleaning procedure in the maintenance section on page 235.

C. Ensure all covers are intact and that the ventilator does not show signs of excessive wear or corrosion on the visible metal parts.

12.2 Connection of equipotential bonding cable

Note: If hospital guidelines require equipotential bonding of the medical devices connect as described below. (Equipotential bonding involves connecting together all non-current carrying metalwork to form a zone within which it is not possible for exposed metalwork to be at different voltage levels, which could cause a shock i.e. to create an earthed equipotential zone).

The ventilator is equipped with one rear mounted bonding point.

Connect the equipotential bonding cable (1) to the rear equipotential bonding stud (2).

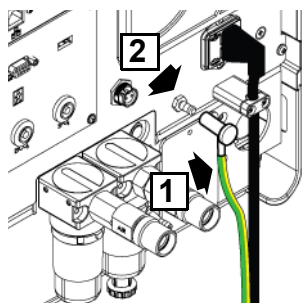

Connect the free end of the equipotential bonding cable from the ventilator (3) to the equipotential bonding point (4).

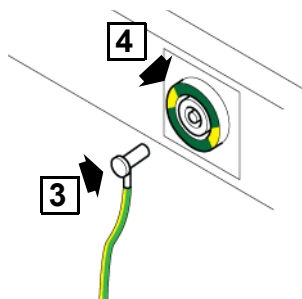

12.3 Connection of mains power

Note: Hospital environment may provide unswitched sockets for medical devices.

12.3.1 IEC/BS 1363/A3 specification power leads

Insert the mains plug into the mains socket.

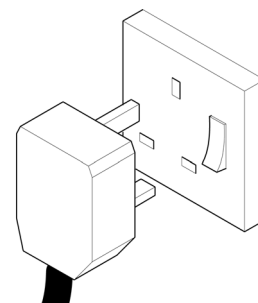

Turn on the mains power

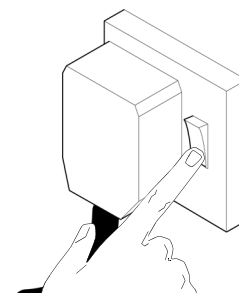

12.3.2 Schuko and NEMA specification power leads

Insert the mains plug into the mains socket.

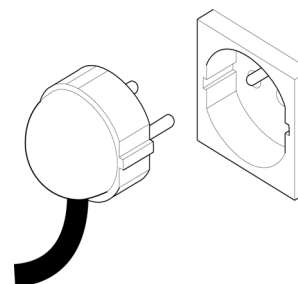

Note: Schuko lead shown.

12.4 Connection of 24V DC auxiliary power

Connect the 24V DC power supply cable to the 24VDC auxiliary power input connector located on the rear of the ventilator.

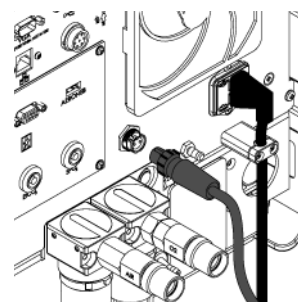

Caution: Use only a medical grade 24V DC power supply with a current rating of 4 A.

Note: The mains cable does not have to be disconnected when using the 24V DC auxiliary power.

12.4.1 Mains or auxiliary power supply - power switch status indicator

When mains or auxiliary power is not connected to the ventilator the halo indicator around the mains switch will be off.



When mains power or auxiliary is connected to a ventilator that is "OFF" the halo indicator around the mains switch will illuminate. A static halo shows that the internal batteries are fully charged.



A flashing halo shows that the internal batteries are partially or fully discharged and they are charging.



12.5 Fitting the silencer and exhalation block

Open the exhalation block access cover.

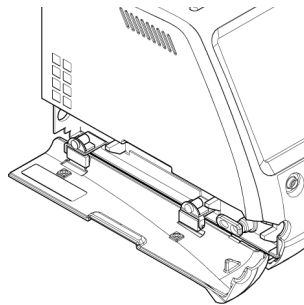

Clean the gas ports with an alcohol wipe.

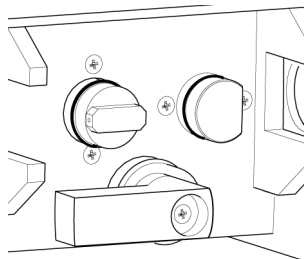

Connect the Silencer and exhalation block together.

The relief valve balls indicate the rear of the exhalation block.

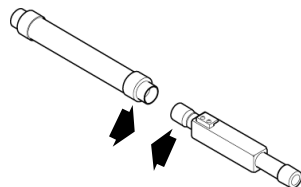

Note: Ensure that the silencer and Exhalation block have been cleaned in accordance with the Cleaning and disinfection instructions on page 235.

Fit the assembly to the gas ports and lock in place.

Note: The user will be unable to close the access cover unless the exhalation block is locked in place.

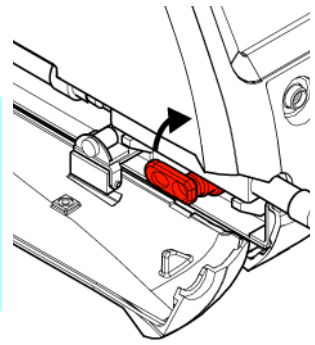

Close the access cover.

12.6 Gas connections

Warning. Check the condition of the gas supply hoses to the ventilator. Do not use any hose that shows signs of cracking, abrasion, kinking, splits, excessive wear or ageing. Make sure that the Air or O₂ hose has not come into contact with oil or grease.

Connect the Air and Oxygen hoses to the rear of the ventilator.

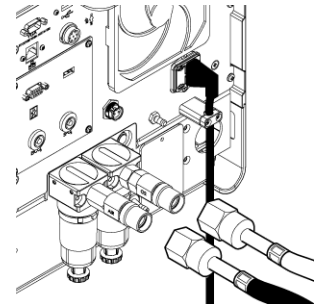

Ensure the connecting nuts are hand tight.

Note: NIST connectors shown.

Connect the probes to the wall connections

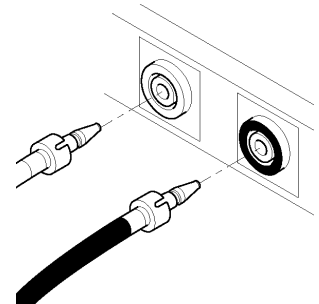

Note: BS probes shown.

12.7 Ventilator - patient & operator position

In a standard setup the ventilator should be placed to one side of the head end of the incubator/cot. The operator position is standing in front of the ventilator.

Routing of the patient circuit is left to the discretion of the user.

Warning. Ensure that the water trap is always situated below the patient.

12.8 Turning the ventilator On

12.8.1 With mains connected

Push and hold the mains switch for 3 seconds.

The halo light should be amber (static or flashing).



The halo light should change colour to green.

The ventilator will now power up and enter standby mode.



The battery icon will be accompanied by the mains power icon to show that the ventilator is running on mains power.



12.8.2 Without mains connected

Push and hold the mains switch for 3 seconds.

The halo light should be off.



The halo light should change colour to green.

The ventilator will now power up and enter standby mode.



The battery icon only will appear to show that the unit is running on battery power.



Note: After the unit enters Standby mode the user will have to acknowledge the Mains power fail alarm message once the Calibrate flow sensor/Flow sensor not connected alarms is cleared.

12.8.3 With DC power connected

Push and hold the mains switch for 3 seconds.

The halo light should be amber (static or flashing).



The halo light should change colour to green.

The ventilator will now power up and enter standby mode.



The DC power icon will appear to show that the unit is running on 24V DC power.



12.9 Pre-use functional test

12.9.1 Power on self test

Each time the ventilator is turned on it will perform a power on self test (POST).

The POST checks the pneumatic unit for correct function. Any issues will be shown by the machine displaying a technical alarm.

The ventilator also activates the visual and audible components of the alarm system.

- 1 Turn the unit on
- 2 Verify that the alarm light bar cycles Red, Amber & Cyan.
- 3 Verify that a single high priority audible alarm was sounded.

12.9.2 Reserve power check

Look at the battery status icon to see the charge status of the reserve power source.



The capacity is rated in a percentage from 100% fully charged to 0% complete discharge.

If using the ventilator without the mains supply or the 24V DC supply the following is a guide to the approximate operating time on the internal battery.

The ventilator will typically run for over 3 hours from 100% battery charge to complete discharge, both in conventional and HFOV modes. Actual battery discharge duration will depend on battery condition and ventilation settings applied. Please refer to the caution for actual safe operation times.

Caution. When the ventilator internal power source reaches 25% the user is required to transfer the patient to an alternate form of ventilation if re-connection to the mains supply is not possible. At 25% the ventilator will display and sound the “Battery Low” alarm.

12.9.3 Patient circuit selection

- 1 To carry out the patient circuit setup, as per chapter '14. Patient circuit selection' on page 50.
- 2 When the patient circuit has been assembled continue with one of the following tests
 - **Invasive dual limb**
Invasive test section '12.9.5 Functional testing (Invasive dual limb)' on page 45.
 - **Non invasive dual limb**
Non invasive test dual limb section '12.9.6 Functional testing (Non invasive dual limb)' on page 46.
 - **Non invasive single limb**
Non invasive test single limb section '12.9.7 Functional testing (Non invasive single limb)' on page 46.

12.9.4 Pre-functional test checks

- Check that the humidifier is turned on. (Refer to the manufacturers instructions for more details).
- Check that the humidification chamber is filled with appropriate sterile water to the designated level.
- Check that the patient circuit heating connector is connected to the humidifier securely. (Refer to the manufacturers instructions for more details).
- Check the patient circuit, make sure all the connections are secure and that the water trap is empty and positioned upright.
- Check that the humidifier temperature probes are correctly inserted into the patient circuit monitoring ports.

12.9.5 Functional testing (Invasive dual limb)

- 1 Remove the flow sensor and test lung.
- 2 Occlude the ET manifold.
- 3 Select and enter CMV mode.

Note: If a 15 mm circuit is fitted select the 15 mm patient circuit setting.

- 4 Press "Continue without flow sensor"
- 5 Set the low PEEP alarm threshold to -1 mbar.
- 6 Ensure that the ventilator is cycling and that no alarms are present.
- 7 Ensure that the set PIP and measured PIP are within 1 mbar.
- 8 Ensure that the set PEEP and measured PEEP are within 1 mbar.

Note: If the readings for step 7 & 8 are outside the stated tolerance check the patient circuit then re-check.

- 9 Disconnect the Air supply.
- 10 Ensure that the "No Air Supply" alarm is triggered.
- 11 Disconnect the Oxygen supply.
- 12 Ensure that the "No Gas" alarm is triggered.
- 13 Re-connect the Air supply.
- 14 Reset the low PIP alarm message.
- 15 Ensure that the "No Oxygen Supply" alarm is triggered.
- 16 Reconnect the oxygen supply.
- 17 Ensure all alarms cancel.
- 18 Select and enter HFOV mode.
- 19 Set a Delta P of 10 mbar.
- 20 Ensure that the ventilator is oscillating and that no alarms are present.
- 21 Ensure that the set MAP and measured MAP are within 1 mbar.

Note: If the reading for step 21 is outside the stated tolerance check the patient circuit then re-check.

- 22 Remove the Fresh Gas limb.
- 23 Ensure that the "Leaking Fresh gas" alarm is triggered.
- 24 Block the fresh gas port.
- 25 Ensure that the "Blocked Fresh gas" alarm is triggered.
- 26 Refit the Fresh Gas limb. Check that all the alarms clear.
- 27 Reconnect the flow sensor and flow sensor cable.
- 28 Calibrate the flow sensor.
- 29 Wait for the text "Calibration completed" to appear.
- 30 Refit the flow sensor and test lung.
- 31 Disconnect the mains power supply.
- 32 Ensure that the "Mains Power Fail" alarm is triggered. Check that the mains power symbol disappears.
- 33 Re-connect the mains power supply.
- 34 Ensure that the "Mains Power Fail" alarm cancels. Check that the mains power symbol reappears.
- 35 Return to standby mode
- 36 Functional testing is now complete.

12.9.6 Functional testing (Non invasive dual limb)

Note: The non invasive ventilation does not require the use of the flow sensor. If the flow sensor or flow sensor cable is connected please disconnect prior to commencing the functional test.

- 1 Select and enter NIPPV D - dual limb mode.
- 2 Occlude the prongs.
- 3 Set the low PEEP alarm threshold to -1 mbar.
- 4 Ensure that the ventilator is cycling and that no alarms are present.
- 5 Ensure that the set PIP and measured PIP are within 1 mbar.
- 6 Ensure that the set PEEP and measured PEEP are within 1 mbar.

Note: If the readings for step 5 & 6 are outside the stated tolerance check the patient circuit then re-check.

- 7 Disconnect the Air supply.
- 8 Ensure that the "No Air Supply" alarm is triggered.
- 9 Disconnect the Oxygen supply.
- 10 Ensure that the "No Gas" alarm is triggered.
- 11 Re-connect the Air supply.
- 12 Reset the low PIP alarm message.
- 13 Ensure that the "No Oxygen Supply" alarm is triggered.
- 14 Reconnect the oxygen supply.
- 15 Ensure all alarms cancel.
- 16 Remove the Fresh Gas limb.
- 17 Ensure that the "Leaking Fresh gas" alarm is triggered.
- 18 Block the fresh gas port.
- 19 Ensure that the "Blocked Fresh gas" alarm is triggered.
- 20 Refit the Fresh Gas limb. Check that all the alarms clear.
- 21 Select and enter NHFOV - dual limb mode.
- 22 Set a Delta P of 10 mbar.
- 23 Ensure that the ventilator is oscillating and that no alarms are present. Ensure that the set MAP and measured MAP are within 1 mbar.

Note: If the reading for step 23 is outside the stated tolerance check the patient circuit then re-check.

- 24 Disconnect the mains power supply.
- 25 Ensure that the "Mains Power Fail" alarm is triggered. Check that the mains power symbol disappears.
- 26 Re-connect the mains power supply.
- 27 Ensure that the "Mains Power Fail" alarm cancels. Check that the mains power symbol reappears.
- 28 Return to standby mode
- 29 Functional testing is now complete.

12.9.7 Functional testing (Non invasive single limb)

Note: The non invasive ventilation does not require the use of the flow sensor. If the flow sensor or flow sensor cable is connected please disconnect prior to commencing the functional test.

- 1 Select and enter nCPAP single limb mode.
- 2 Occlude the prongs
- 3 Set the CPAP control to 5 mbar
- 4 Ensure that the set CPAP and measured CPAP are within 1 mbar.
- 5 Disconnect the Air supply.
- 6 Ensure that the "No Air Supply" alarm is triggered.
- 7 Disconnect the Oxygen supply.
- 8 Ensure that the "No Gas" alarm is triggered.
- 9 Re-connect the Air supply.
- 10 Reset the low PIP alarm message.
- 11 Ensure that the "No Oxygen Supply" alarm is triggered.
- 12 Reconnect the oxygen supply.
- 13 Ensure all alarms cancel.
- 14 Remove the Fresh Gas limb.
- 15 Ensure that the "low pressure" alarm is triggered.
- 16 Block the fresh gas port.
- 17 Ensure that the "Blocked Fresh gas" alarm is triggered.
- 18 Refit the Fresh Gas limb. Check that all the alarms clear.
- 19 Disconnect the mains power supply.
- 20 Ensure that the "Mains Power Fail" alarm is triggered. Check that the mains power symbol disappears.
- 21 Re-connect the mains power supply.

- 22 Ensure that the “Mains Power Fail” alarm cancels. Check that the mains power symbol reappears.
- 23 Return to standby mode
- 24 Functional testing is now complete.

12.10 Turning the ventilator Off

On completion of the session the user should enter standby mode. Press and hold the power button for 2 seconds.



The information panel will be replaced by the shutdown dialog box and button.

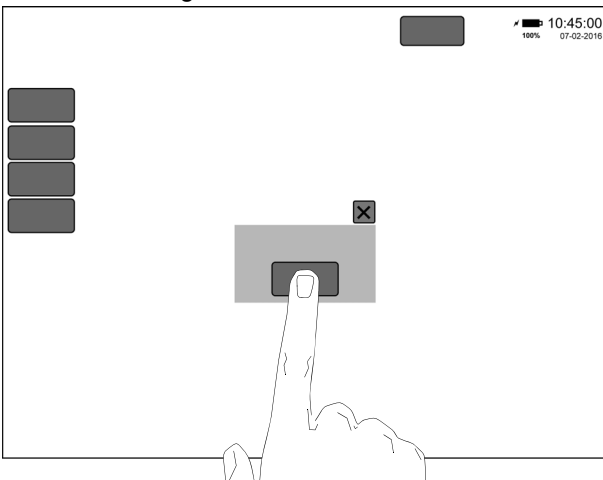

Note: The shutdown dialog box will time out after 10 seconds if no action is taken.

The user will have to repress the power switch momentarily to cancel the “Power fail” audible alarm.

Warning: If the audible power fail alarm does not sound, remove the ventilator from service and refer the unit for repair.

12.10.1 Isolation from mains supply

To isolate the ventilator from the mains supply remove the mains plug.

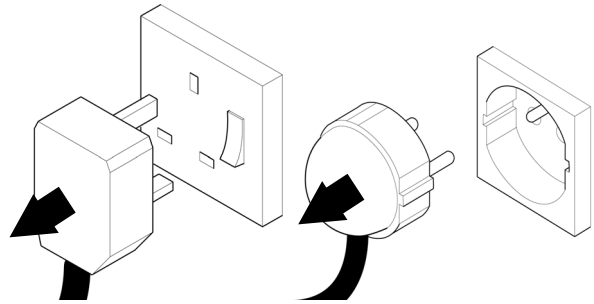

Warning: Ensure that the ventilator is not positioned in such a way that it is difficult to operate the disconnection of the device.

13. Battery care and storage instructions

The SLE6000 contains two Lithium Ion battery packs.

Whilst the ventilator is in use the batteries will be continually charged.

When the ventilator is turned OFF and disconnected from the mains the control PCB will monitor the batteries as they will slowly discharge over time. When the batteries reach full discharge the control PCB will shut the cell down to prevent deep discharge damage.

Once a battery has been shut down it will no longer charge when the ventilator is turned on and the ventilator will display a battery fault alarm message.

If the above condition has found to have occurred then replace the batteries.

13.1 Battery care

Ensure that the batteries are always fully charged.

If the batteries have been fully discharged after a mains power fail event then they should be recharged as soon as possible.

13.1.1 Storage less than 6 months.

If the ventilator is to be stored for a period of less than 6 months then it should remain connected to mains power during this period.

The ventilator can be stored disconnected from the mains. After return to service ensure that the batteries are fully recharged.

13.1.2 Storage greater than 6 months.

If the ventilator is to be stored for a period of greater than 6 months then it should remain connected to mains power during this period.

If the ventilator is be stored disconnected from the mains then the batteries need to be disconnected. Reconnect the batteries on return to service ensure that the batteries are fully recharged.

Please refer to the service manual for more information.

Patient circuit selection

See “Assembly of BC6188 (Ø10 mm) or BC6198 (Ø15 mm) patient circuit” on page 50.

See “Assembly of BC6188/DHW patient circuit” on page 54.

See “Modification of BC6188 or BC6188/DHW circuits for non-invasive dual limb ventilation.” on page 57.

See “Modification of BC6188 or BC6188/DHW circuits for non-invasive single limb ventilation.” on page 58.



14. Patient circuit selection

The SLE6000 has three patient circuits that are approved for use.

BC6188 Single use Neonatal/Infant breathing circuit – 10mm tubing, single heated wire. (Conventional and HFOV)

BC6188/DHW Single use Neonatal/Infant breathing circuit – 10/15mm tubing, dual heated wire. (Conventional and HFOV)

BC6198 Single use Paediatric breathing circuit – 15mm tubing (Conventional use only).

14.1 Type of ventilation

14.1.1 Invasive

It is recommended for patients requiring tidal volumes of less than 50 ml to use either **BC6188** or **BC6188/DHW** patient circuits for conventional and oscillatory ventilation.

It is recommended for patients requiring tidal volumes of greater than 50 ml to use **BC6198** patient circuits for conventional ventilation only.

14.1.2 Non-Invasive (Dual limb)

Use either:

BC6188

BC6188/DHW

See “Modification of BC6188 or BC6188/DHW circuits for non-invasive dual limb ventilation.” on page 57.

14.1.3 Non-Invasive (Single limb)

Use

BC6188.

BC6188/DHW

See “Modification of BC6188 or BC6188/DHW circuits for non-invasive single limb ventilation.” on page 58.

14.1.4 Non-Invasive O₂ therapy (Single limb)

Use

BC6188.

BC6188/DHW

See “Modification of BC6188 or BC6188/DHW circuits for non-invasive single limb O₂ therapy.” on page 61.

14.1.4.1 Patient circuit selection

The invasive mode panel contains two buttons that allow the user to select between 10mm and 15mm diameter patient circuits.

Patient Circuit
10mm

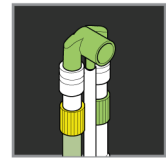

15mm

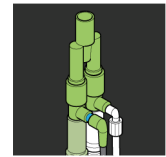

Note: The selection of 15mm patient circuits is only available for invasive ventilation. Changing to non-invasive ventilation automatically selects 10mm patient circuits.

14.2 Assembly of BC6188 (Ø10 mm) or BC6198 (Ø15 mm) patient circuit

The following instruction covers the assembly of the Ø10 mm BC6188 patient circuit (Neonatal) and the Ø15 mm BC6198 patient circuit (Paediatric). Both are single heated limb circuits.

14.2.1 Bacterial filters

Caution: The use of bacterial filters between the fresh gas port and humidifier supply line & exhalation block and the expiratory supply line is recommended.

- 1 Fit the single use bacterial filter (A) to the exhalation port from patient port.
- 2 Fit the single use bacterial filter (B) to the fresh gas to patient port.

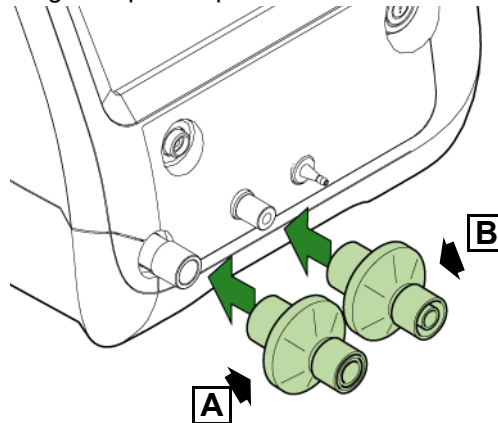

Please refer to the consumable catalogue or the SLE website for part numbers.

14.2.2 Humidification chamber

Ensure that the chamber is fitted securely to the humidifier and filled to the correct level with sterile water..

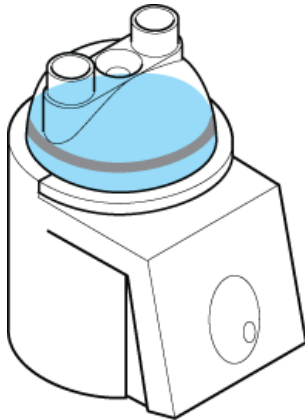

Note: These instructions are illustrated with a standard single use humidification chamber.

Auto fill and reusable chambers can also be used. Reusable chambers will require the use of an adaptor for the fresh gas supply.

Note: Please refer to the humidifier user manual for warnings, cautions and operating instructions.

Please refer to patient circuit instructions for use for warnings and cautions and operating instructions.

1 Remove the patient circuit from protective bag.

Note: The BC6188 circuit is not supplied with a humidification chamber (G).

2 Connect the 15mm female end (C) of the fresh gas supply line (D) to the to the bacterial filter fitted to the ventilator port marked "Fresh Gas to Patient" (E).

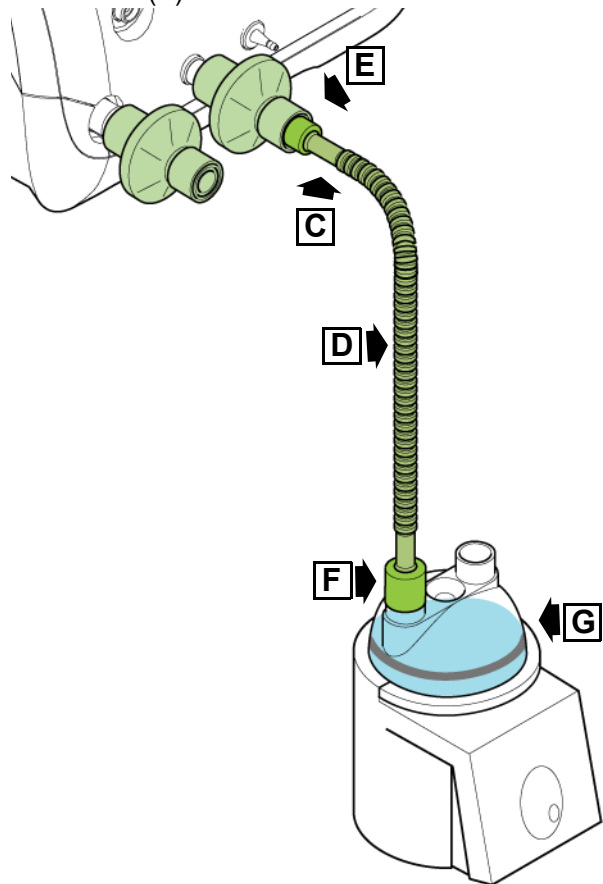

3 Connect the free end (F) of the fresh gas supply line (D) to one of the ports of the humidification chamber (G).

4 The remaining section of the circuit is supplied assembled.

5 Connect the heated limb (H) to the free port of the humidification chamber (I).

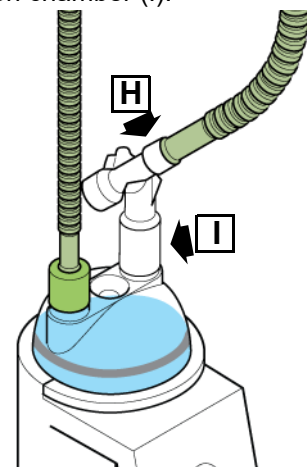

- 6 Connect the exhalation limb (J) to the bacterial filter fitted to the exhalation port (K) marked "Exhalation port from Patient".

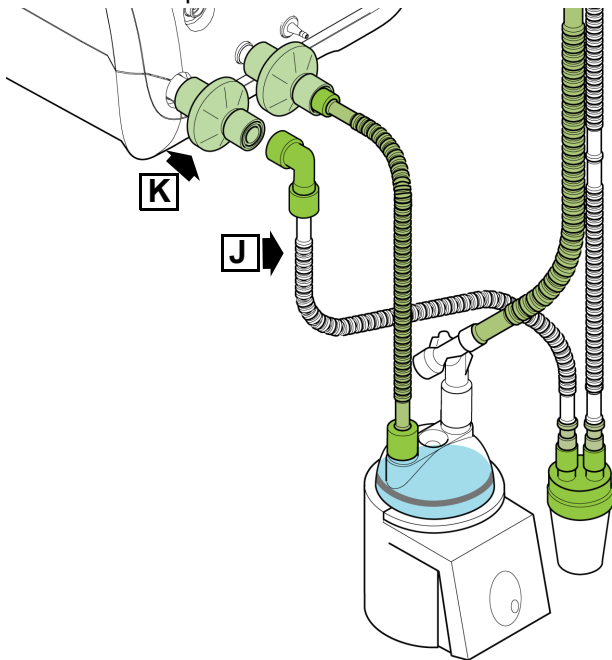

Warning. Ensure that the water trap is always situated lower than the patient.

- 7 Connect the proximal airway line (L) to the proximal airway port (M) marked "Proximal Airway".

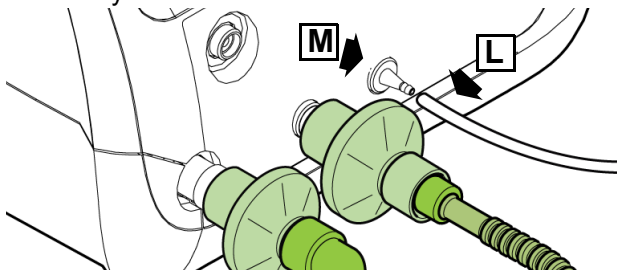

14.2.3 Fitting the temperature probes to a BC6188 patient circuit

- 8 Connect the humidifier temperature probes to ports (N & O).

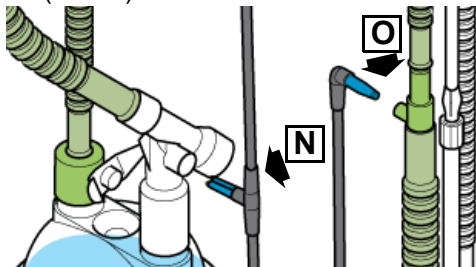

- 9 Ensure the clip (P) is placed over the temperature probe to ensure correct orientation.

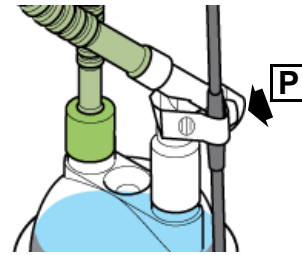

14.2.4 Fitting the temperature probes to a BC6198 patient circuit

- 10 Connect the humidifier temperature probes to ports (N & O).

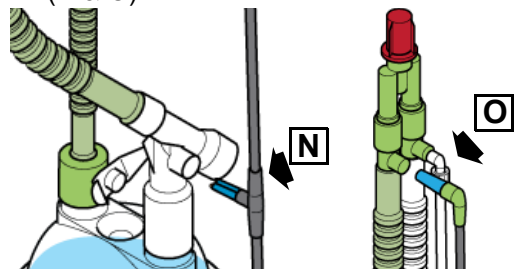

- 11 Ensure the clip (P) is placed over the temperature probe to ensure correct orientation.

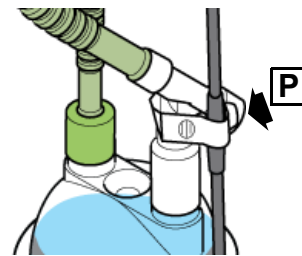

- 12 Connect the humidifier heater wire lead (Q) to the port on the inspiratory heated limb (H).

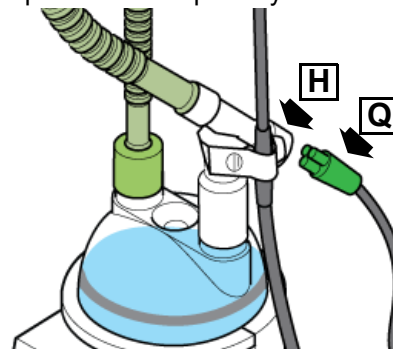

- 13 Connect the heater wire (Q) and the temperature probes (R) to the humidifier.

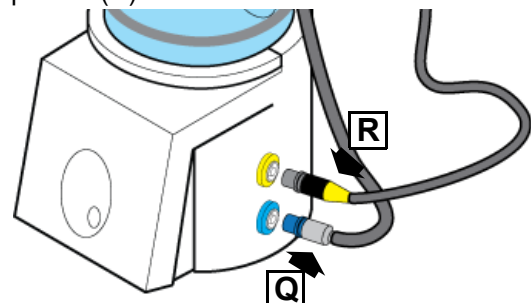

- 14 Connect the flow sensor cable (S) to the electrical connector on the front of the ventilator marked "Flow sensor" (T).

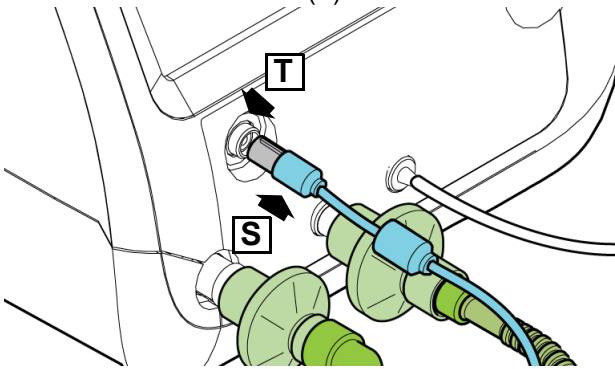

- 15 Connect the flow sensor cable to the flow sensor. Ensure that the cable connector key fits into the rear notch of the flow sensor connector.

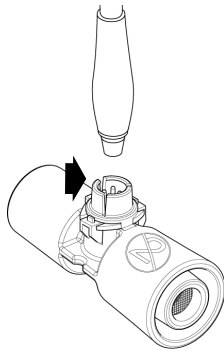

Note: If the patient circuit is being assembled with the ventilator turned off skip steps 16 and 20.

- 16 The ventilator will alarm calibrate flow sensor. Press the "Calibrate" button in the information bar to activate the sensor panel or press the "Utilities" button or the "Calibration and Utilities" Button.

- 17 Occlude the flow sensor to prevent any flow across the sensor wires.

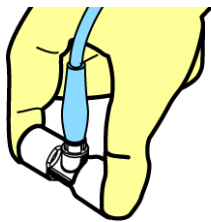

Caution: To avoid contamination of the flow sensor use gloves when calibrating.

- 18 Press the Start calibration button and the following text "Calibrating.." will be displayed above the button
- 19 When the calibrations has passed the test "Calibration completed" will appear.
- 20 The flow sensor is now calibrated.

14.2.5 Fitting the flow sensor to a BC6188 patient circuit

- 21 Remove the dust cap (U) from the ET manifold (V).

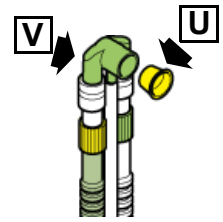

- 22 Insert the flow sensor (W) into the ET manifold (V).

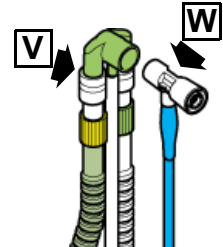

- 23 The patient circuit is now ready to use.

Note: Application of the ET tube is not covered in this manual.

14.2.6 Fitting the flow sensor to a BC6198 patient circuit

- 24 Remove the dust cap (U) from the ET manifold (V).

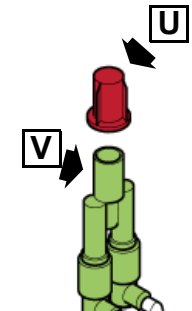

- 25 Insert the flow sensor (W) into the ET manifold (V).

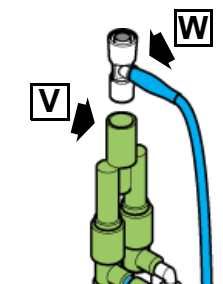

- 26 The patient circuit is now ready to use.

Note: Application of the ET tube is not covered in this manual.

14.2.7 Fitting the test lung

Once the patient circuit is assembled connect the test lung (X) to the flow sensor (W). The circuit is ready for pre use functional testing.

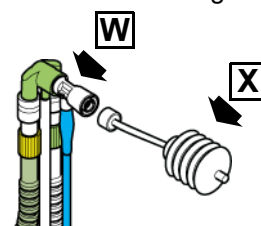

14.3 Assembly of BC6188/DHW patient circuit

The following instruction covers the assembly of the Ø10 mm BC6188/DHW patient circuit (Neonatal) a dual heated limb circuit.

14.3.1 Bacterial filters

Caution: The use of bacterial filters between the fresh gas port and humidifier supply line & exhalation block and the expiratory supply line is recommended.

- 1 Fit the single use bacterial filter (A) to the exhalation port from patient port.
- 2 Fit the single use bacterial filter (B) to the fresh gas to patient port.

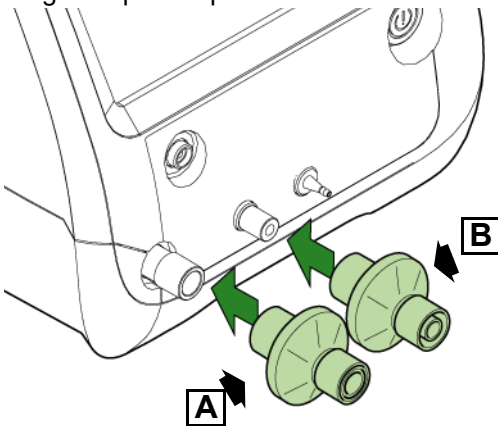

Please refer to the consumable catalogue or the SLE website for part numbers.

14.3.2 Humidification chamber

Ensure that the chamber is fitted securely to the humidifier and filled to the correct level with sterile water..

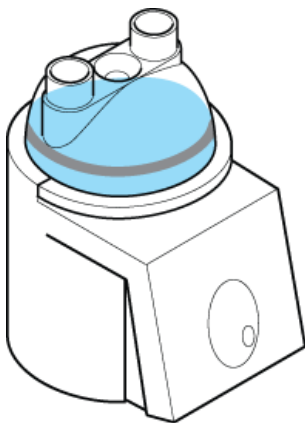

Note: Please refer to the humidifier user manual for warnings, cautions and operating instructions.

Please refer to patient circuit instructions for use for warnings and cautions and operating instructions.

Note: This setup requires a dual heater wire lead.

- 1 Remove the patient circuit from protective bag.
- 2 Connect the 15mm female end (C) of the fresh gas supply line (D) to the bacterial filter fitted to the ventilator port marked "Fresh Gas to Patient" (E).

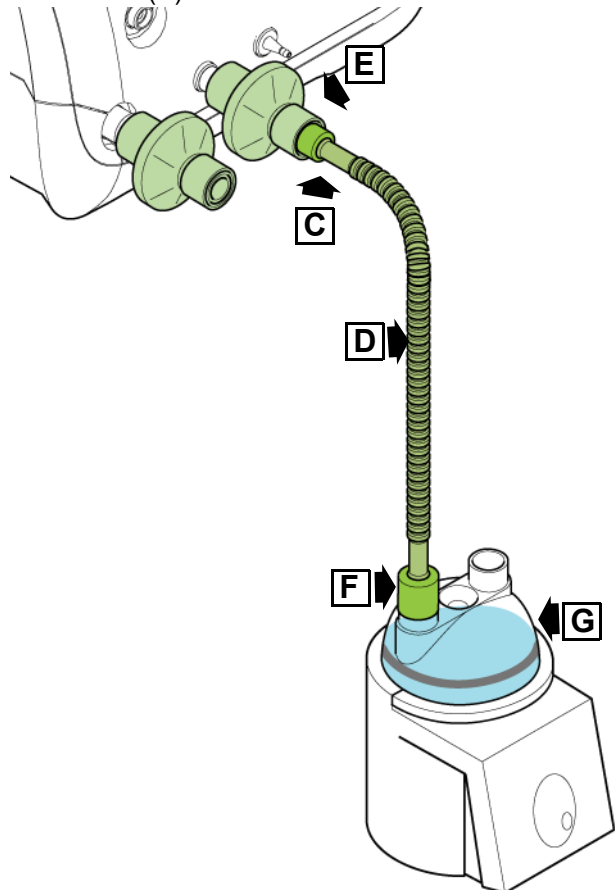

- 3 Connect the free end (F) of the fresh gas supply line (D) to one of the ports of the humidification chamber (G).
- 4 The remaining section of the circuit is supplied assembled.

- 5 Connect the heated limb (H) to the free port of the humidification chamber (I).

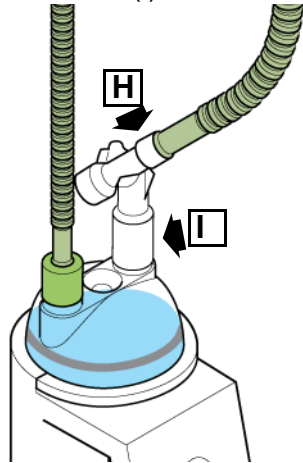

- 6 Connect the exhalation limb (J) to the bacterial filter fitted to the exhalation port (K) marked "Exhalation port from Patient".

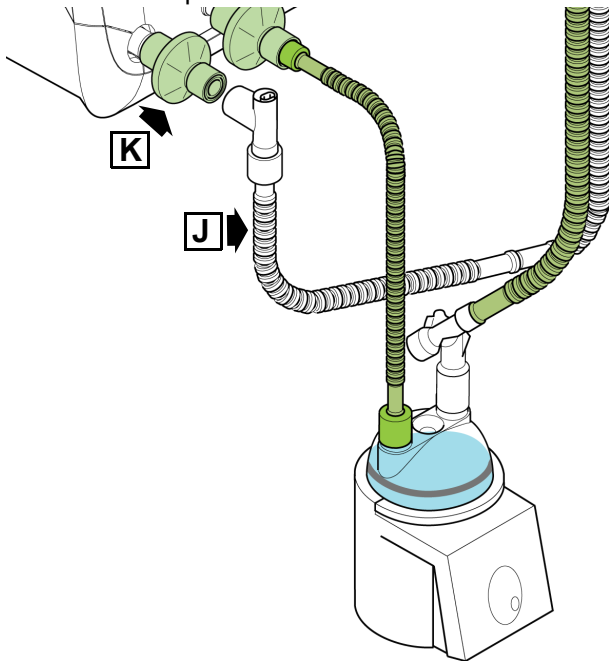

- 7 Connect the proximal airway line (L) to the proximal airway port (M) marked "Proximal Airway".

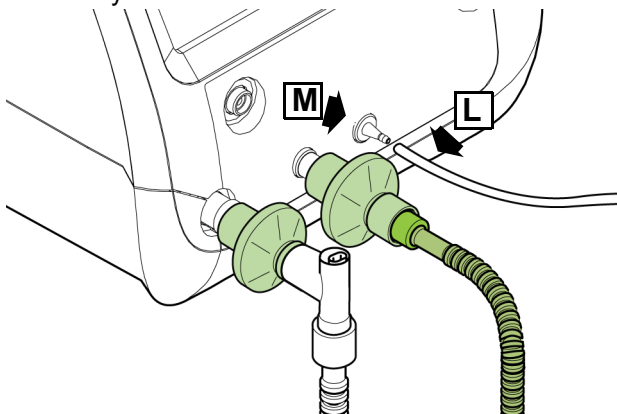

- 8 Connect the humidifier temperature probes to ports (N & O).

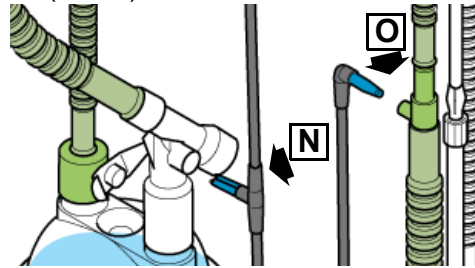

- 9 Ensure the clip (P) is placed over the temperature probe to ensure correct orientation.

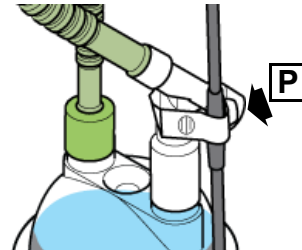

- 10 Connect the inspiratory limb heater wire lead to the port (Q) on the inspiratory heated limb (H).

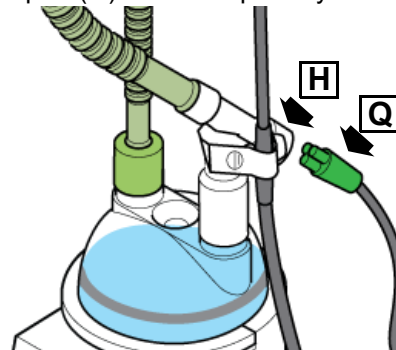

- 11 Connect the expiratory heater wire lead to the port (Q) on the expiratory heated limb (R).

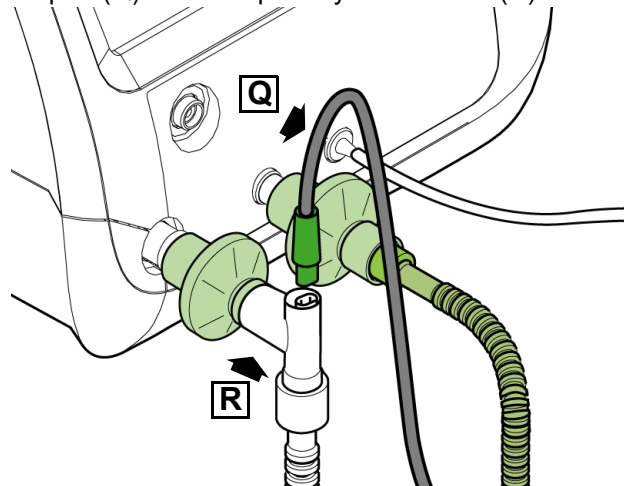

- 12 Connect the heater wire (S) and the temperature probes (T) to the humidifier.

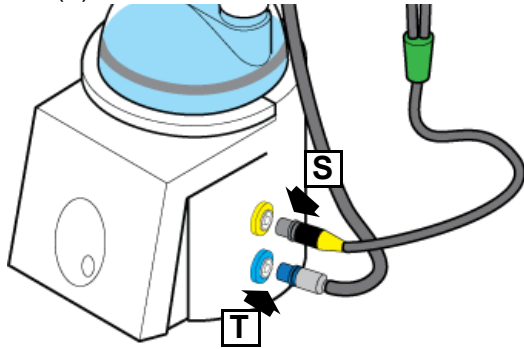

- 13 Connect the flow sensor cable (U) to the electrical connector on the front of the ventilator marked "Flow sensor" (V).

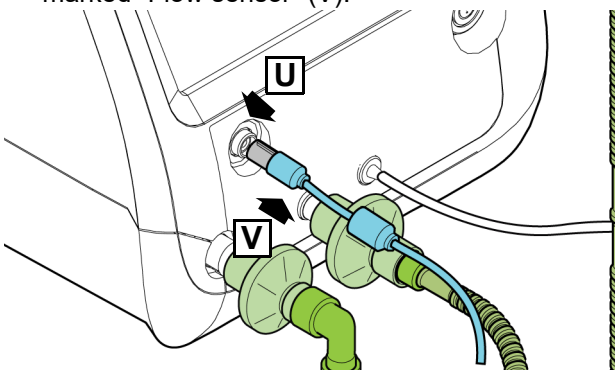

- 14 Connect the flow sensor cable to the flow sensor. Ensure that the cable connector key fits into the rear notch of the flow sensor connector.

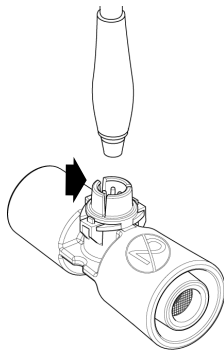

Note: If the patient circuit is being assembled with the ventilator turned off skip steps 15 and 19.

- 15 The ventilator will alarm calibrate flow sensor. Press the "Calibrate" button in the information bar to activate the sensor panel or press the "Utilities" button or the "Calibration and Utilities" Button.

- 16 Occlude the flow sensor to prevent any flow across the sensor wires.

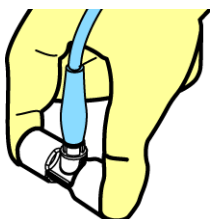

Caution: To avoid contamination of the flow sensor use gloves when calibrating .

- 17 Press the Start calibration button and the following text "Calibrating.." will be displayed above the button

- 18 When the calibrations has passed the test "Calibration completed" will appear.

- 19 The flow sensor is now calibrated.

- 20 Remove the dust cap (W) from the ET manifold (X).

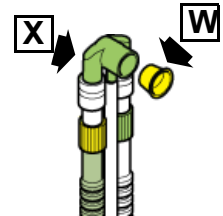

- 21 Insert the flow sensor (Y) into the ET manifold (V).

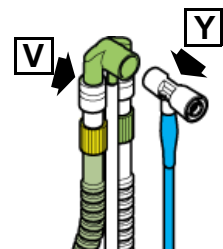

- 22 The patient circuit is now ready to use.

Note: Application of the ET tube is not covered in this manual.

14.3.3 Fitting the test lung

Once the patient circuit is assembled connect the test lung (Z) to the flow sensor (Y). The circuit is ready for pre use functional testing.

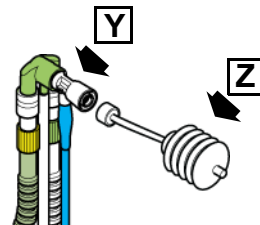

14.4 Modification of BC6188 or BC6188/DHW circuits for non-invasive dual limb ventilation.

Note: The flow sensor and flow sensor cable are not required for this set up.

- 1 Assemble the BC6188 patient circuit as per section 14.2 on page 50 or the BC6188/DHW patient circuit section 14.3 on page 54.
- 2 Disconnect the proximal airway line (A) from the ET manifold (B) at the luer connector.

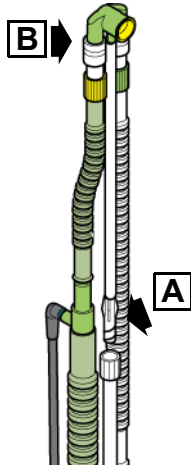

- 3 Disconnect the ET manifold (B) from the inspiratory limb (C) and expiratory limb (D).

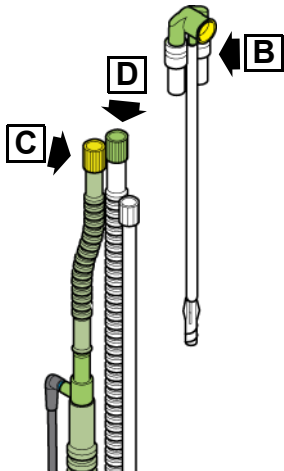

- 4 Remove the luer adaptor (E) from the accessory bag supplied with the circuit.

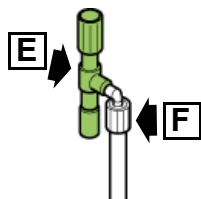

- 5 Connect the proximal airway line (F) to the adaptor.

- 6 Insert the adaptor (G) into the expiratory limb (D).

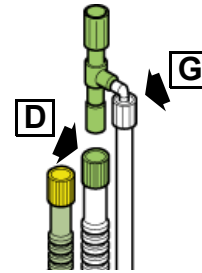

14.4.1 Fitting a dual limb nCPAP generator.

- 7 Remove the nCPAP generator (H) from its packaging.
- 8 Connect the generator into the inspiratory limb (C) and expiratory limb (D) of the patient circuit.

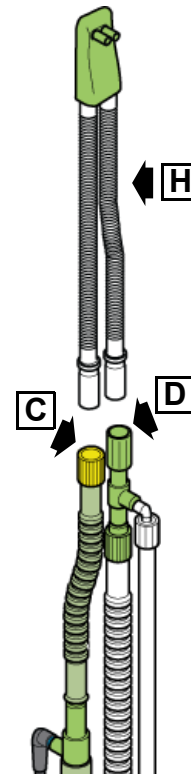

Note: Application of the prongs/mask are not covered in this manual. Please refer to the instruction for use supplied with the nCPAP generator.

14.5 Modification of BC6188 or BC6188/ DHW circuits for non-invasive single limb ventilation.

Note: The flow sensor and flow sensor cable are not required for this set up.

14.5.1 Bacterial filters

Caution: The use of bacterial filters between the fresh gas port and humidifier supply line & exhalation block and the expiratory supply line is recommended.

- 1 Fit the single use bacterial filter (A) to the fresh gas to patient port (B).

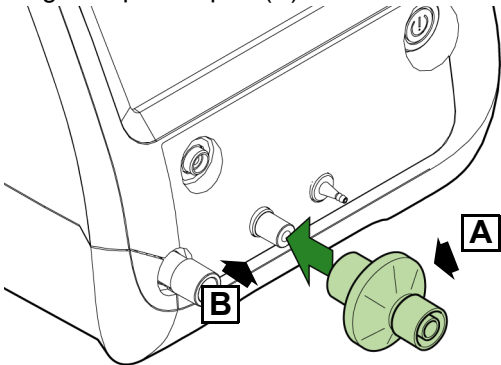

Please refer to the consumable catalogue or the SLE website for part numbers.

14.5.2 Humidification chamber

Ensure that the chamber is fitted securely to the humidifier and filled to the correct level with sterile water..

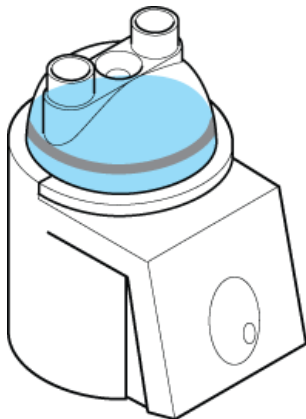

Note: Please refer to the humidifier user manual for warnings, cautions and operating instructions.

Please refer to patient circuit instructions for use for warnings and cautions and operating instructions.

- 1 Remove the patient circuit from protective bag.

Note: The BC6188 circuit is not supplied with a humidification chamber (G).

- 2 Connect the 15mm female end (C) of the fresh gas supply line (D) to the bacterial filter fitted to the ventilator port marked "Fresh Gas to Patient" (E).

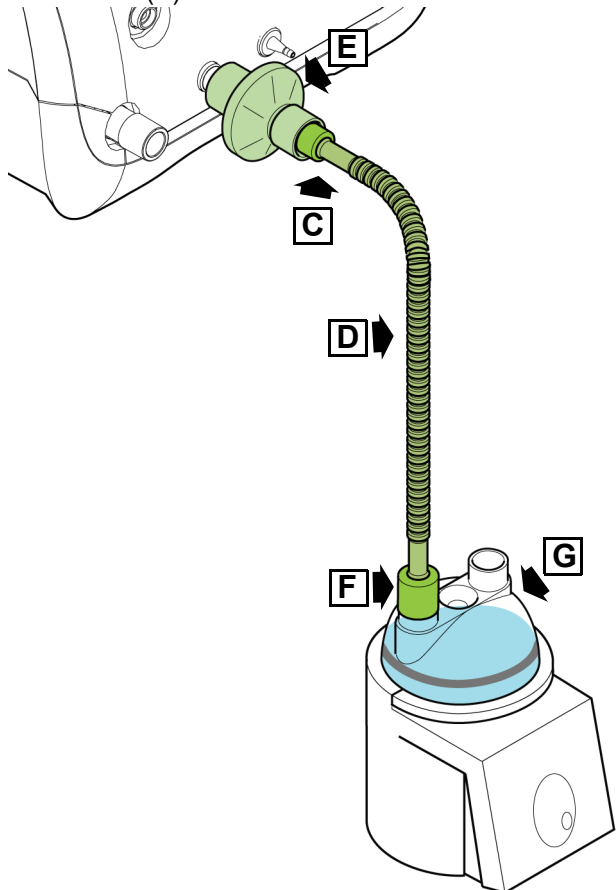

- 3 Connect the free end (F) of the fresh gas supply line (D) to one of the ports of the humidification chamber (G).

- 4 Disconnect the inspiratory limb (H) from the circuit at the temperature probe port and proximal airway line (I) from ET manifold by unscrewing the luer connector.

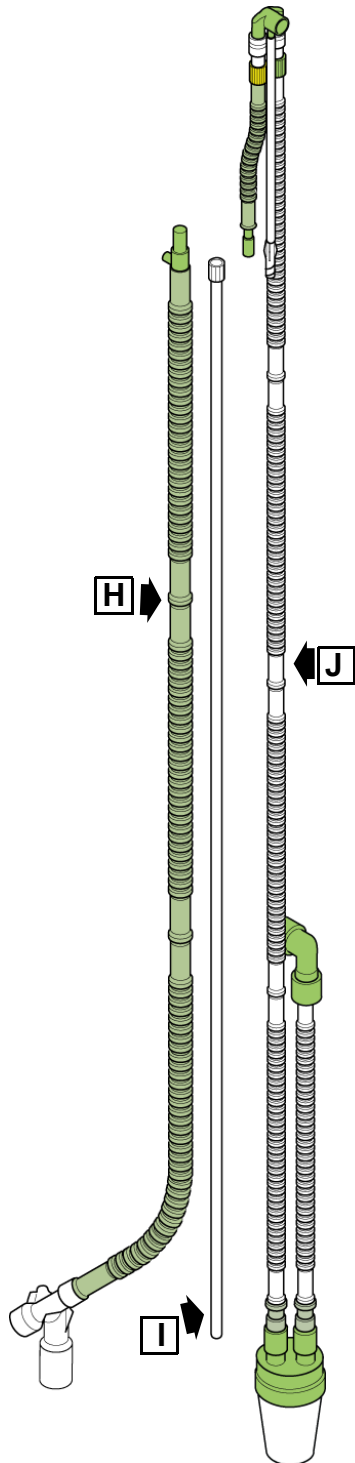

- 5 Replace the remaining part of the circuit (J) back into its original packaging.

- 6 Connect the heated limb (H) to the free port of the humidification chamber (G).

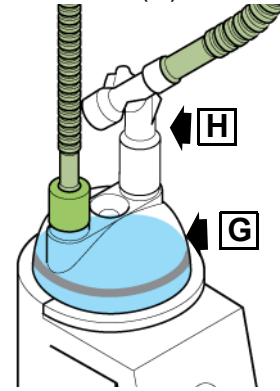

- 7 Connect the proximal airway line (K) to the bacterial filter fitted to the proximal airway port (L) marked "Proximal Airway".

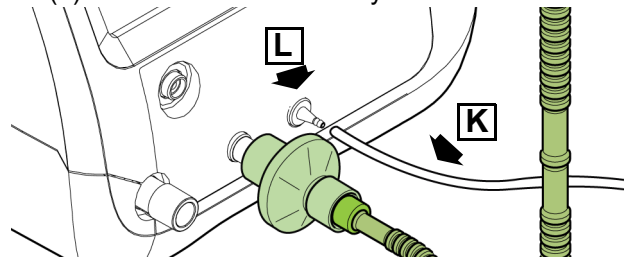

14.5.3 Fitting the temperature probes

- 8 Connect the humidifier temperature probes to ports (M & N).

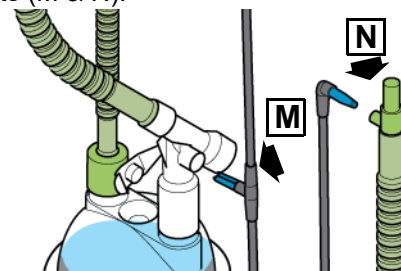

- 9 Ensure the clip (O) is placed over the temperature probe to ensure correct orientation.

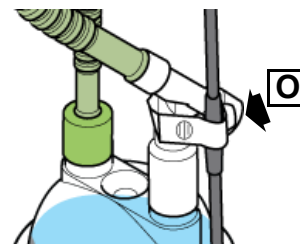

- 10 Connect the humidifier heater wire lead (O) to the port on the inspiratory heated limb (H).

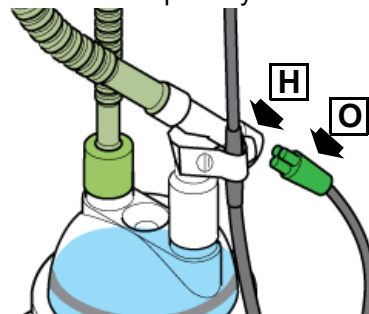

- 11 Connect the heater wire (O) and the temperature probes (P) to the humidifier.

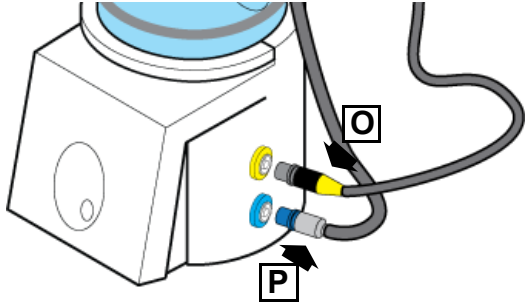

Note: Application of the prongs/mask are not covered in this manual. Please refer to the instruction for use supplied with the nCPAP generator.

14.5.4 Fitting a single limb nCPAP generator.

- 12 Remove the nCPAP generator (Q) from its packaging.
- 13 Connect the generator into the inspiratory (H) limb of the patient circuit.

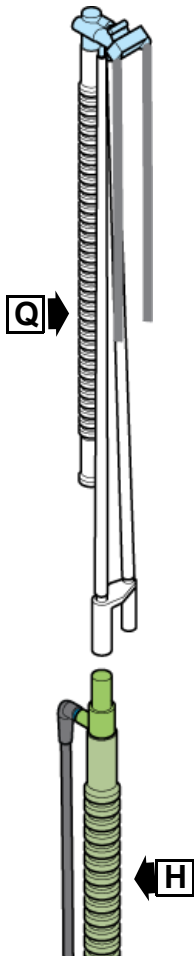

- 14 Connect the proximal airway line (I) to the pressure monitoring line port (R) on the nCPAP generator.

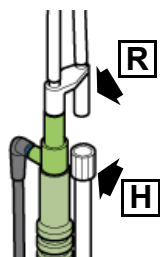

14.6 Modification of BC6188 or BC6188/ DHW circuits for non-invasive single limb O₂ therapy.

Note: The flow sensor and flow sensor cable are not required for this set up.

14.6.1 Bacterial filters

Caution: The use of bacterial filters between the fresh gas port and humidifier supply line & exhalation block and the expiratory supply line is recommended.

- 1 Fit the single use bacterial filter (A) to the fresh gas to patient port (B).

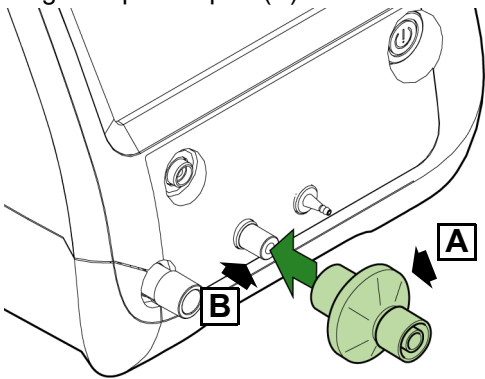

Please refer to the consumable catalogue or the SLE website for part numbers.

14.6.2 Humidification chamber

Ensure that the chamber is fitted securely to the humidifier and filled to the correct level with sterile water..

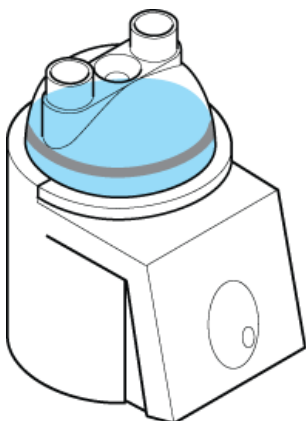

Note: Please refer to the humidifier user manual for warnings, cautions and operating instructions.

Please refer to patient circuit instructions for use for warnings and cautions and operating instructions.

- 1 Remove the patient circuit from protective bag.

Note: The BC6188 circuit is not supplied with a humidification chamber (G).

- 2 Connect the 15mm female end (C) of the fresh gas supply line (D) to the bacterial filter fitted to the ventilator port marked "Fresh Gas to Patient" (E).

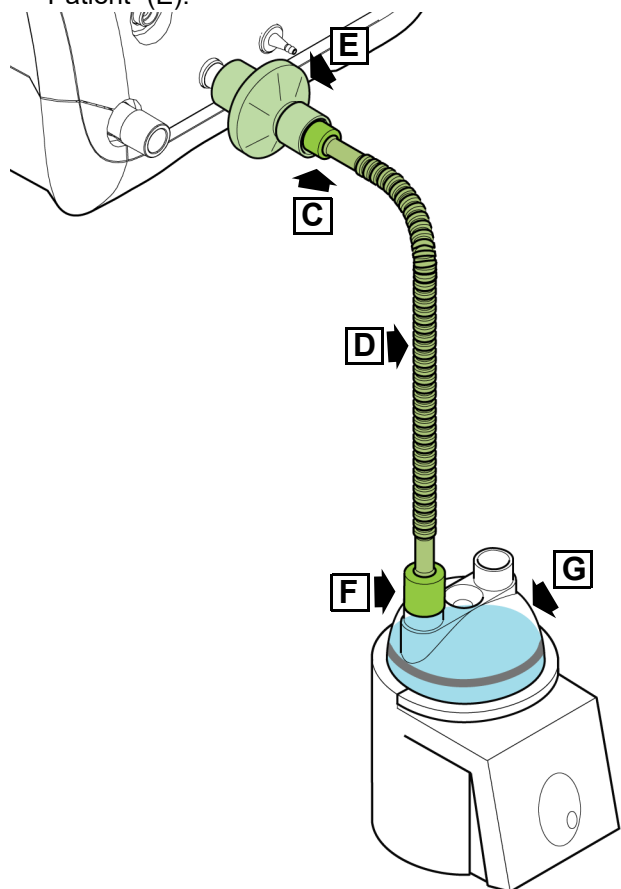

- 3 Connect the free end (F) of the fresh gas supply line (D) to one of the ports of the humidification chamber (G).

- 4 Disconnect the inspiratory limb (H) from the circuit at the temperature probe port.

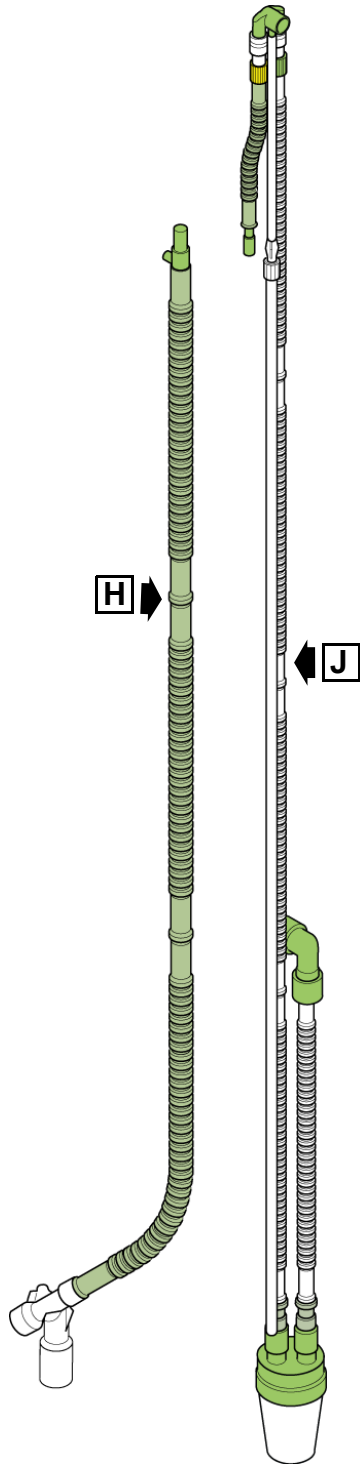

- 5 Replace the remaining part of the circuit (J) back into its original packaging.

- 6 Connect the heated limb (H) to the free port of the humidification chamber (G).

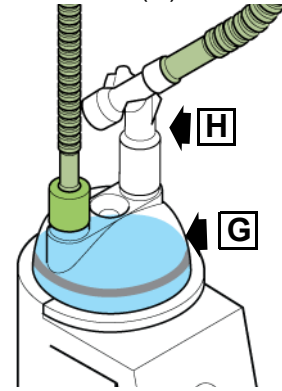

14.6.3 Fitting the temperature probes

- 7 Connect the humidifier temperature probes to ports (K & L).

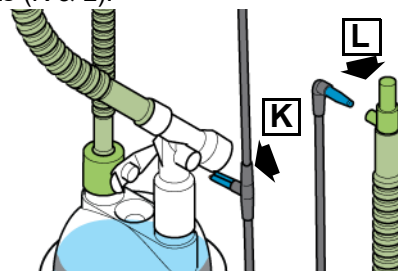

- 8 Ensure the clip (M) is placed over the temperature probe to ensure correct orientation.

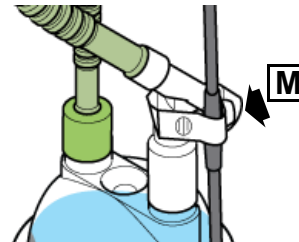

- 9 Connect the humidifier heater wire lead (N) to the port on the inspiratory heated limb (H).

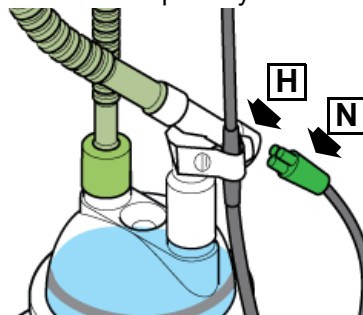

- 10 Connect the heater wire (O) and the temperature probes (P) to the humidifier.

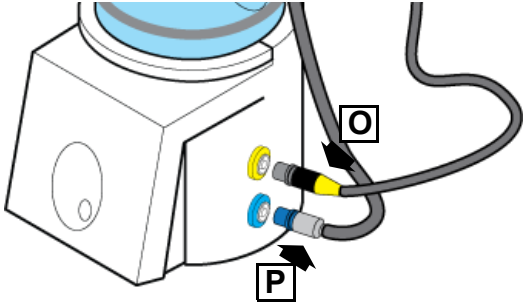

Caution: Select the correct size nasal cannula, the nasal prong outer diameter should be approximately half the diameter of the infant's nares.

14.6.4 Fitting a oxygen therapy nasal cannula.

Note: The user will need to use the O2 therapy patient circuit adaptor N4318 (R) to connect the cannula to the therapy circuit.

- 11 Remove the (Q) from its packaging.
12 Connect the cannula to the inspiratory limb (H) of the patient circuit using the adaptor (R).

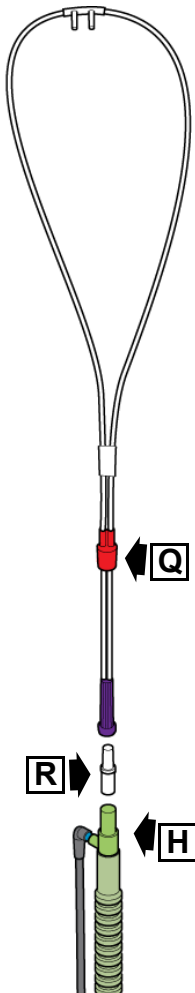



Note: Application of the cannula is not covered in this manual. Please refer to the instruction for use supplied with the cannula.

This page is intentionally left blank.

Ventilation - Invasive

“CPAP” on page 66 

“CMV” on page 68 

“PTV” on page 70 

“PSV” on page 72 

“SIMV” on page 74 

“HFOV” on page 76 

“HFOV+CMV” on page 78 



15. Ventilation - Invasive

15.1 CPAP







Mode type: Invasive

Prior to and after connection, it is the user's responsibility to adjust and monitor the ventilation parameters.

<p>Additional Parameters Active for 120 seconds when mode selected.</p>	<p>RR backup Press and hold the control for 2 seconds to switch On/Off. Press confirm to acknowledge. (Default 40 BPM when On).</p>	<p>Rise time Alters the pressure wave shape.</p>		<p>Trigger sensitivity The operation of the Trigger sensitivity control is modified when no flow sensor is connected. The sensitivity unit changes from l/min to percentage (%). The default is changed from 0.6 l/min to 50%.</p>	
<p>Manual Breath</p>					
<p>Manual breath</p>	<p>Ti Inspiratory time The inspiration time in seconds.</p>		<p>CPAP Continuous positive airway pressure in mbar.</p>	<p>PIP Peak inspiratory pressure in mbar. For manual and backup breaths.</p>	<p>O2 Oxygen concentration delivered to patient.</p>
<p>Alternate function Inspiratory hold.</p>	<p>Interactive controls A. The Ti control cannot be increased beyond the set RR backup rate. B. The RR backup rate control cannot be increased beyond the allowable Ti. C. The Rise time cannot be increased beyond the set Ti.</p>		<p>Interactive controls The CPAP control cannot be increased beyond the set PIP. The PIP cannot be decreased below the set CPAP.</p>	<p>Alternate function O2 Boost O2 suction</p> <p>+</p> <p>Auto O₂</p>	

Note. The above values are shown at their factory default settings.



<p>CPAP default alarm thresholds</p>	<p>Vte Set maximum and minimum thresholds. (Thresholds invisible) High Alarm name: Tidal volume above high threshold Low Alarm name: Tidal volume below low threshold.</p>	<p>Vmin Set maximum and minimum thresholds. (Thresholds invisible) High Alarm name: Minute volume high threshold exceeded Low Alarm name: Minute volume below low threshold.</p>	<p>RR Set maximum threshold. (Thresholds invisible) Alarm name: BPM too high.</p>	<p>Apnoea Set maximum Apnoea time limit. Can be set to Off (See warning below) (Thresholds invisible) Alarm name: Period between patient effort exceeds apnoea limit.</p>	<p> O2 % Set maximum threshold. (Thresholds invisible) Alarm name: O2 over set limit.</p>	<p>Leak Set maximum percentage leak threshold. (Thresholds invisible) Alarm name: High patient leak.</p>
	<p>Vte (ml)</p> <p>30.0 7.0 00.0</p>	<p>Vmin (l)</p> <p>18.00 0.25 00.0</p>	<p>RR (BPM)</p> <p>100 0</p>	<p>Apnoea (seconds)</p> <p>15</p>	<p>O2 (%)</p> <p>60 21</p>	<p>Leak (%)</p> <p>35 0</p>
	<p>PIP (mbar)</p> <p>20 15.0 11</p>	<p>CPAP (mbar)</p> <p>7.0 4.0 1</p>	<p>etCO2 (mmHg)</p> <p>50 -- 20</p>	<p>SpO2 (%)</p> <p>99 -- 88</p>	<p>PR (min)</p> <p>180 -- 100</p>	
<p>Warning: Ventilation with the Apnoea alarm "OFF" The user must use an alternative method of detecting an apnoeic episode, with the Apnoea alarm turned "OFF".</p>	<p>PIP Set maximum and minimum thresholds. High Alarm name: PIP too high (Threshold Visible) Low Alarm name: PIP too low (Threshold Invisible).</p>	<p>CPAP Set maximum and minimum thresholds. High Alarm name: PEEP too high (Threshold Invisible) Low Alarm name: Pressure below low threshold (Threshold Visible).</p>	<p> etCO2 Set maximum and minimum etCO2 thresholds. Only active when etCO2 module connected.</p>	<p> SpO2 Set maximum and minimum SpO2 thresholds. Only active when SpO2 module connected.</p>	<p> PR Set maximum and minimum pulse rate thresholds. Only active when SpO2 module connected.</p>	

15.2 CMV







Mode type: Invasive

Prior to and after connection, it is the user's responsibility to adjust and monitor the ventilation parameters.

<p>Additional Parameters Active for 120 seconds when mode selected.</p>								
<p>Additional Parameters</p>								
<p>Manual Breath</p>	<p>RR 30 1 BPM 150</p>	<p>Rise time 0.04 0.0 Seconds 3.0</p>	<p>Ti 0.40 0.1 Seconds 3.0</p>	<p>PEEP 4.0 0.0 mbar 35.0</p>	<p>PIP 15 0 mbar 65</p>	<p>VTV Off 2.0 ml 300.0</p>	<p>O2 21 21 % 100</p>	
<p>Manual breath</p>	<p>RR Respiratory rate in breath per minute.</p>	<p>Ti Inspiratory time The inspiration time in seconds.</p>	<p>PEEP Positive expiratory end pressure in mbar.</p>	<p>PIP Peak inspiratory pressure in mbar. For manual and backup breaths.</p>	<p>VTV Press and hold the control for 2 seconds to switch On/Off. Press confirm to acknowledge.</p>	<p>O2 Oxygen concentration delivered to patient.</p>		
<p>Alternate function Inspiratory hold.</p>	<p>Interactive controls A. The Ti control cannot be increased beyond the set RR backup rate. B. The RR backup rate control cannot be increased beyond the allowable Ti. C. The Rise time cannot be increased beyond the set Ti.</p>						<p>Alternate function O2 Boost O2 suction</p>  <p>+</p>  <p>Auto O₂</p>	
			<p>Interactive controls The PEEP control cannot be increased beyond the set PIP. The PIP cannot be decreased below the set PEEP.</p>					

Note. The above values are shown at their factory default settings.



CMV default alarm thresholds	<p>Vte</p> <p>Set maximum and minimum thresholds. (Thresholds invisible) High Alarm name: Tidal volume above high threshold Low Alarm name: Tidal volume below low threshold.</p>	<p>Vmin</p> <p>Set maximum and minimum thresholds. (Thresholds invisible) High Alarm name: Minute volume high threshold exceeded Low Alarm name: Minute volume below low threshold.</p>	 <p>O2 %</p> <p>Set maximum threshold. (Thresholds invisible) Alarm name: O2 over set limit.</p>	<p>Leak</p> <p>Set maximum percentage leak threshold. (Thresholds invisible) Alarm name: High patient leak.</p>	
	<p>Vte (ml)</p>	<p>Vmin (l)</p>	<p>O2 (%)</p>	<p>Leak (%)</p>	
	<p>30.0</p>	<p>18.00</p>	<p>60</p>	<p>35</p>	
	<p>7.0</p>	<p>0.25</p>	<p>21</p>	<p>0</p>	
	<p>00.0</p>	<p>00.0</p>			
	<p>PIP (mbar)</p>	<p>PEEP (mbar)</p>	<p>etCO2 (mmHg)</p>	<p>SpO2 (%)</p>	<p>PR (min)</p>
	<p>20</p>	<p>7.0</p>	<p>50</p>	<p>99</p>	<p>180</p>
	<p>15.0</p>	<p>4.0</p>	<p>--</p>	<p>--</p>	<p>--</p>
	<p>11</p>	<p>1</p>	<p>20</p>	<p>88</p>	<p>100</p>
	<p>PIP</p> <p>Set maximum and minimum thresholds. High Alarm name: PIP too high (Threshold Visible) Low Alarm name: PIP too low (Threshold Invisible).</p>	<p>PEEP</p> <p>Set maximum and minimum thresholds. High Alarm name: PEEP too high (Threshold Invisible) Low Alarm name: Pressure below low threshold (Threshold Visible).</p>	 <p>etCO2</p> <p>Set maximum and minimum etCO2 thresholds. Only active when etCO2 module connected.</p>	 <p>SpO2</p> <p>Set maximum and minimum SpO2 thresholds. Only active when SpO2 module connected.</p>	 <p>PR</p> <p>Set maximum and minimum pulse rate thresholds. Only active when SpO2 module connected.</p>

15.3 PTV







Mode type: Invasive

Prior to and after connection, it is the user's responsibility to adjust and monitor the ventilation parameters.

<p>Additional Parameters Active for 120 seconds when mode selected.</p>							
<p>Additional Parameters</p>							
<p>Manual Breath</p>	<p>RR 30 1 BPM 150</p>	<p>Rise time 0.04 0.0 Seconds 3.0</p>	<p>PEEP 4.0 0.0 mbar 35.0</p>	<p>Trig Sens 0.6 0.2 l/min 20.0</p>	<p>PIP 15 0 mbar 65</p>	<p>VTV Off 2.0 ml 300.0</p>	<p>O2 21 21 % 100</p>
<p>Manual breath</p>	<p>RR Respiratory rate in breath per minute.</p>	<p>Ti Inspiratory time The inspiration time in seconds.</p>	<p>PEEP Positive end expiratory pressure in mbar.</p>	<p>PIP Peak inspiratory pressure in mbar. For manual and backup breaths.</p>	<p>VTV Press and hold the control for 2 seconds to switch On/Off. Press confirm to acknowledge.</p>	<p>O2 Oxygen concentration delivered to patient.</p>	
<p>Alternate function Inspiratory hold.</p>	<p>Interactive controls A. The Ti control cannot be increased beyond the set RR backup rate. B. The RR backup rate control cannot be increased beyond the allowable Ti. C. The Rise time cannot be increased beyond the set Ti.</p>						<p>Alternate function O2 Boost O2 suction</p>  <p>+</p>  <p>Auto O₂</p>
<p>Interactive controls The PEEP control cannot be increased beyond the set PIP. The PIP cannot be decreased below the set PEEP.</p>							

Note. The above values are shown at their factory default settings.



PTV default alarm thresholds	<p>Vte</p> <p>Set maximum and minimum thresholds. (Thresholds invisible) High Alarm name: Tidal volume above high threshold Low Alarm name: Tidal volume below low threshold.</p>	<p>Vmin</p> <p>Set maximum and minimum thresholds. (Thresholds invisible) High Alarm name: Minute volume high threshold exceeded Low Alarm name: Minute volume below low threshold.</p>	<p>RR</p> <p>Set maximum threshold. (Thresholds invisible) Alarm name: BPM too high</p>	 <p>O2 %</p> <p>Set maximum threshold. (Thresholds invisible) Alarm name: O2 over set limit.</p>	<p>Leak</p> <p>Set maximum percentage leak threshold. (Thresholds invisible) Alarm name: High patient leak.</p>
	Vte (ml)	Vmin (l)	RR (BPM)	O2 (%)	Leak (%)
↑ ↓	30.0	18.00	100	60	35
	7.0	0.25	0	21	0
↑ ↓	00.0	00.0			
			<p>Apnoea (seconds)</p> <p>OFF</p>		
	PIP (mbar)	PEEP (mbar)	etCO2 (mmHg)	SpO2 (%)	PR (min)
↑ ↓	20	7.0	50	99	180
	15.0	4.0	--	--	--
↑ ↓	11	1	20	88	100
<p>Warning: Ventilation with the Apnoea alarm "OFF" The user must use an alternative method of detecting an apnoeic episode, with the Apnoea alarm turned "OFF"</p>	<p>PIP</p> <p>Set maximum and minimum thresholds. High Alarm name: PIP too high (Threshold Visible) Low Alarm name: PIP too low (Threshold Invisible).</p>	<p>PEEP</p> <p>Set maximum and minimum thresholds. High Alarm name: PEEP too high (Threshold Invisible) Low Alarm name: Pressure below low threshold (Threshold Visible).</p>	 <p>etCO2</p> <p>Set maximum and minimum etCO2 thresholds. Only active when etCO2 module connected.</p>	 <p>SpO2</p> <p>Set maximum and minimum SpO2 thresholds. Only active when SpO2 module connected.</p>	 <p>PR</p> <p>Set maximum and minimum pulse rate thresholds. Only active when SpO2 module connected.</p>

15.4 PSV











Mode type: Invasive

Prior to and after connection, it is the user's responsibility to adjust and monitor the ventilation parameters.

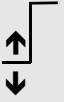
<p>Additional Parameters Active for 120 seconds when mode selected.</p>		<p>Rise time Alters the pressure wave shape.</p>		<p>Trigger sensitivity The operation of the Trigger sensitivity control is modified when no flow sensor is connected. The sensitivity unit changes from l/min to percentage (%). The default is changed from 0.6 l/min to 50%.</p>	<p>Termination sensitivity Sets the termination sensitivity the patient breath.</p>	
<p>Additional Parameters</p>		<p>Rise time 0.04 0.0 Seconds 3.0</p>		<p>Trig Sens 0.6 0.2 l/min 20.0</p>	<p>Term Sens 5 5 % 50</p>	
<p>Manual Breath</p>	<p>RR 30 1 BPM 150</p>	<p>Ti Max 0.40 0.1 Seconds 3.0</p>	<p>PEEP 4.0 0.0 mbar 35.0</p>	<p>PIP 15 0 mbar 65</p>	<p>VTV Off 2.0 ml 300.0</p>	<p>O2 21 21 % 100</p>
<p>Manual breath Alternate function Inspiratory hold.</p>	<p>RR Respiratory rate in breath per minute. Interactive controls A. The Ti control cannot be increased beyond the set RR backup rate. B. The RR backup rate control cannot be increased beyond the allowable Ti. C. The Rise time cannot be increased beyond the set Ti.</p>	<p>Ti Max Inspiratory time The inspiration time in seconds.</p>	<p>PEEP Positive end expiratory pressure in mbar. Interactive controls The PEEP control cannot be increased beyond the set PIP. The PIP cannot be decreased below the set PEEP.</p>	<p>PIP Peak inspiratory pressure in mbar. For manual and backup breaths. PIP MAX When VTV is on the control is renamed PIP MAX. Use to set the maximum allowable PIP.</p>	<p>VTV Press and hold the control for 2 seconds to switch On/Off. Press confirm to acknowledge. VTV Target When VTV is on the control is renamed VTV target. Use to set the target volume.</p>	<p>O2 Oxygen concentration delivered to patient. Alternate function O2 Boost O2 suction  +  Auto O2</p>

Note. The above values are shown at their factory default settings.



PSV default alarm thresholds	Vte Set maximum and minimum thresholds. (Thresholds invisible) High Alarm name: Tidal volume above high threshold Low Alarm name: Tidal volume below low threshold.	Vmin Set maximum and minimum thresholds. (Thresholds invisible) High Alarm name: Minute volume high threshold exceeded Low Alarm name: Minute volume below low threshold.	RR Set maximum threshold. (Thresholds invisible) Alarm name: BPM too high	Apnoea Set max Apnoea time limit. Set to Off as default (See warning below) (Thresholds invisible) Alarm name: Period between patient effort exceeds apnoea limit.	 O2 % Set maximum threshold. (Thresholds invisible) Alarm name: O2 over set limit.	Leak Set maximum percentage leak threshold. (Thresholds invisible) Alarm name: High patient leak.
	Vte (ml)	Vmin (l)	RR (BPM)	O2 (%)	Leak (%)	
	30.0	18.00	100	60	35	
	7.0	0.25	0	21	0	
	00.0	00.0				
			Apnoea (seconds)			
			OFF			
	PIP (mbar)	PEEP (mbar)	etCO2 (mmHg)	SpO2 (%)	PR (min)	
	20	7.0	50	99	180	
	15.0	4.0	--	--	--	
	11	1	20	88	100	
<p>Warning: Ventilation with the Apnoea alarm "OFF" The user must use an alternative method of detecting an apnoeic episode, with the Apnoea alarm turned "OFF"</p>	PIP Set maximum and minimum thresholds. High Alarm name: PIP too high (Threshold Visible) Low Alarm name: PIP too low (Threshold Invisible).	PEEP Set maximum and minimum thresholds. High Alarm name: PEEP too high (Threshold Invisible) Low Alarm name: Pressure below low threshold (Threshold Visible).	 etCO2 Set maximum and minimum etCO2 thresholds. Only active when etCO2 module connected.	 SpO2 Set maximum and minimum SpO2 thresholds. Only active when SpO2 module connected.	 PR Set maximum and minimum pulse rate thresholds. Only active when SpO2 module connected.	





15.5 SIMV



Mode type: Invasive

Prior to and after connection, it is the user's responsibility to adjust and monitor the ventilation parameters.

<p>Additional Parameters Active for 120 seconds when mode selected.</p>							<p>Pressure Support Press and hold the control for 2 seconds to switch On/Off. Press confirm to acknowledge. (Default 8 mbar when On).</p>	<p>Trigger sensitivity The operation of the Trigger sensitivity control is modified when no flow sensor is connected. The sensitivity unit changes from l/min to percentage (%). The default is changed from 0.6 l/min to 50%.</p>	<p>Termination sensitivity Sets the termination sensitivity the patient breath. This parameter is on only when pressure support is on.</p>	
<p>Additional Parameters</p>							<p>Rise time Alters the pressure wave shape.</p>			
<p>Manual Breath</p>	<p>RR 30 1 BPM 150</p>	<p>Ti 0.40 0.1 Seconds 3.0</p>	<p>PEEP 4.0 0.0 mbar 35.0</p>	<p>PIP 15 0 mbar 65</p>	<p>VTV Off 2.0 ml 300.0</p>	<p>O2 21 21 % 100</p>	<p>Rise time</p>	<p>P Support</p>	<p>Trig Sens</p>	<p>Term Sens</p>
<p>Manual breath</p>	<p>RR Respiratory rate in breath per minute.</p>	<p>Ti Inspiratory time The inspiration time in seconds.</p>	<p>PEEP Positive end expiratory pressure in mbar</p>	<p>PIP Peak inspiratory pressure in mbar. For manual and backup breaths.</p>	<p>VTV Press and hold the control for 2 seconds to switch On/Off. Press confirm to acknowledge.</p>	<p>O2 Oxygen concentration delivered to patient.</p>				
<p>Alternate function Inspiratory hold</p>	<p>Interactive controls A. The Ti control cannot be increased beyond the set RR backup rate. B. The RR backup rate control cannot be increased beyond the allowable Ti. C. The Rise time cannot be increased beyond the set Ti</p>						<p>PIP MAX When VTV is on the control is renamed PIP MAX. Use to set the maximum allowable PIP.</p>	<p>VTV Target When VTV is on the control is renamed VTV target. Use to set the target volume.</p>	<p>Alternate function O2 Boost O2 suction</p>  <p>+</p>  <p>Auto O₂</p>	
<p>Note. The above values are shown at their factory default settings.</p>							<p>Interactive controls The PEEP control cannot be increased beyond the set PIP. The PIP cannot be decreased below the set PEEP.</p>			

SIMV default alarm thresholds	Vte Set maximum and minimum thresholds. (Thresholds invisible) High Alarm name: Tidal volume above high threshold Low Alarm name: Tidal volume below low threshold.	Vmin Set maximum and minimum thresholds. (Thresholds invisible) High Alarm name: Minute volume high threshold exceeded Low Alarm name: Minute volume below low threshold.	RR Set maximum threshold. (Thresholds invisible) Alarm name: BPM too high	Apnoea Set max Apnoea time limit. Set to Off as default (See warning below) (Thresholds invisible) Alarm name: Period between patient effort exceeds apnoea limit.	 O2 % Set maximum threshold. (Thresholds invisible) Alarm name: O2 over set limit.	Leak Set maximum percentage leak threshold. (Thresholds invisible) Alarm name: High patient leak.
	Vte (ml)	Vmin (l)	RR (BPM)	O2 (%)	Leak (%)	
	30.0	18.00	100	60	35	
	7.0	0.25	0	21	0	
	00.0	00.0				
			Apnoea (seconds)			
			OFF			
	PIP (mbar)	PEEP (mbar)	etCO2 (mmHg)	SpO2 (%)	PR (min)	
	20	7.0	50	99	180	
	15.0	4.0	--	--	--	
	11	1	20	88	100	
Warning: Ventilation with the Apnoea alarm "OFF" The user must use an alternative method of detecting an apnoeic episode, with the Apnoea alarm turned "OFF"	PIP Set maximum and minimum thresholds. High Alarm name: PIP too high (Threshold Visible) Low Alarm name: PIP too low (Threshold Invisible).	PEEP Set maximum and minimum thresholds. High Alarm name: PEEP too high (Threshold Invisible) Low Alarm name: Pressure below low threshold (Threshold Visible).	 etCO2 Set maximum and minimum etCO2 thresholds. Only active when etCO2 module connected.	 SpO2 Set maximum and minimum SpO2 thresholds. Only active when SpO2 module connected.	 PR Set maximum and minimum pulse rate thresholds. Only active when SpO2 module connected.	







15.6 HFOV



Mode type: Invasive

Prior to and after connection, it is the user's responsibility to adjust and monitor the ventilation parameters.

<p>Oscillation Pause The oscillations can be paused for 60 seconds by pressing the oscillation paused button. Press and hold the control for 1 seconds to switch On/Off.</p>	<p>Interactive controls The sigh RR cannot be increased beyond the limit dictated by the set sigh inspiratory time. The sigh inspiratory time cannot be increased beyond the limit set by the set sigh RR.</p>					
<p>Additional Parameters Active for 120 seconds when mode selected.</p>	<p>Sigh RR Press and hold the control for 2 seconds to switch On/Off. Press confirm to acknowledge. (Default 30 BPM when On). Sets the respiratory rate for the sigh breaths.</p>	<p>Sigh Ti Sets the inspiratory time for the sigh breath.</p>		<p>Sigh P Sets the inspiratory pressure for the sigh breath.</p>	<p>ΔP MAX When the VTV control is ON the control is renamed ΔP MAX. The maximum allowable Delta pressure in mbar.</p>	
<p>Oscillation Pause</p>	<p>Sigh RR Off 1 BPM 150</p>	<p>Sigh Ti 0.40 0.1 Seconds 3.0</p>		<p>Sigh P 10 0 mbar 45</p>		
<p>Additional Parameters</p>	<p>Frequency 10.0 3.0 Hz 20.0</p>	<p>I:E 1:1 1 Ratio 3</p>	<p>MAP 5 0 mbar 45</p>	<p>ΔP 4 4 mbar 180</p>	<p>VTV Off 2.0 ml 50.0</p>	<p>O2 21 21 % 100</p>
<p>Sigh* The sigh control will initiate a pause at the set Sigh Ti.</p>	<p>Frequency HFO frequency in Hertz (Hz).</p>	<p>I:E Ratio for inspiration to expiration (1:1, 1:2 & 1:3).</p>	<p>MAP Mean airway pressure in mbar.</p>	<p>ΔP Delta pressure in mbar.</p>	<p>VTV Press and hold the control for 2 seconds to switch On/Off. Press confirm to acknowledge.</p>	<p>O2 Oxygen concentration delivered to patient.</p>
<p>Alternate function Sigh hold.</p>	<p>Interactive controls The Sigh Hold will use the user preference set 5 or 10 second pause.</p>		<p>Interactive controls MAP and Sigh P A. The MAP control will automatically start to increase the Sigh P when it passes the set level of Sigh P and the Sigh P will track the MAP. B. If the MAP is decreased the Sigh P will remain at the new level. In this case the difference between MAP and Sigh P can be greater than 15 mbar. D. The Sigh P can be increased independently of the set MAP but only 15 mbar above the set MAP.</p>		<p>Vte Target When VTV is on the control is renamed VTe target. Use to set the target volume.</p>	<p>Alternate function O2 Boost O2 suction</p>
<p>Caution*: With the Sigh RR set to Off the Sigh Ti can be set anywhere between 0.1 and 3 seconds for manual sighs. When Sigh RR is subsequently turned on the Sigh Ti could be incompatible with the set Sigh RR. The user will have to adjust the Sigh Ti or the Sigh RR accordingly.</p>						
<p>Note. The above values are shown at their factory default settings.</p>	<p>Alternate function with Interactive controls</p>	<p>Frequency and VTV target Pressing and holding the Frequency control for 2 seconds will link it to the Vte target control. Increasing or decreasing the HFO Frequency will automatically adjust the Vte target control.</p>				
						<p>Alternate function O2 Boost O2 suction + Auto O2</p>

HFOV default alarm thresholds	<p>Vte Set maximum and minimum thresholds. (Thresholds invisible) High Alarm name: Tidal volume above high threshold Low Alarm name: Tidal volume below low threshold.</p>	<p>Vmin Set maximum and minimum thresholds. (Thresholds invisible) High Alarm name: Minute volume high threshold exceeded Low Alarm name: Minute volume below low threshold.</p>	 <p>O2 % Set maximum threshold. (Thresholds invisible) Alarm name: O2 over set limit.</p>	<p>Leak Set maximum percentage leak threshold. (Thresholds invisible) Alarm name: High patient leak</p>
	<p>Vte (ml)</p>	<p>Vmin (l)</p>	<p>O2 (%)</p>	<p>Leak (%)</p>
	<p>30.0</p>	<p>18.00</p>	<p>60</p>	<p>35</p>
	<p>7.0</p>	<p>0.25</p>	<p>21</p>	<p>0</p>
	<p>00.0</p>	<p>00.0</p>		
	<p>Paw (mbar)</p>	<p>Paw (mbar)</p>	<p>SpO2 (%)</p>	<p>PR (min)</p>
	<p>17</p>	<p>2.0</p>	<p>99</p>	<p>180</p>
	<p>5.0</p>	<p>2.0</p>	<p>--</p>	<p>--</p>
		<p>-7</p>	<p>88</p>	<p>100</p>
	<p>High Paw Set maximum and minimum thresholds. High Alarm name: High Paw (Threshold Visible).</p>	<p>Low Paw Set maximum and minimum thresholds. Low Alarm name: Low Pressure (Threshold Visible).</p>	 <p>SpO2 Set maximum and minimum SpO2 thresholds. Only active when SpO2 module connected.</p>	 <p>PR Set maximum and minimum pulse rate thresholds. Only active when SpO2 module connected.</p>

15.7 HFOV+CMV



Mode type: Invasive

Prior to and after connection, it is the user's responsibility to adjust and monitor the ventilation parameters.

Oscillation Pause

The oscillations can be paused for 60 seconds by pressing the oscillation paused button. Press and hold the control for 1 seconds to switch On/Off.

HFO Activity

Allows the selection of oscillations in both inspiratory and expiratory phases, or just the expiratory phase.

Additional Parameters

Active for 120 seconds when mode selected.

Oscillation Pause Additional Parameters		HFO Activity				
RR 30 1 BPM 150	Ti 0.40 0.1 Seconds 3.0	Frequency 10 3.0 Hz 20.0	PEEP 4.0 0.0 mbar 35.0	PIP 15 0 mbar 65	ΔP 4 4 mbar 180	O2 21 21 % 100
RR Respiratory rate in breath per minute.	Ti Inspiratory time The inspiration time in seconds.	Frequency HFO frequency in Hertz (Hz)	PEEP Positive end expiratory pressure in mbar	PIP Peak inspiratory pressure in mbar. For manual and backup breaths.	ΔP Delta pressure in mbar.	O2 Oxygen concentration delivered to patient.
Interactive controls A. The Ti control cannot be increased beyond the set RR backup rate. B. The RR backup rate control cannot be increased beyond the allowable Ti. C. The Rise time cannot be increased beyond the set Ti		Interactive controls The PEEP control cannot be increased beyond the set PIP. The PIP cannot be decreased below the set PEEP.		Alternate function O2 Boost O2 suction + Auto O2		

Note. The above values are shown at their factory default settings.

**HFOV+CMV
default alarm
thresholds**



O2 %
Set maximum
threshold.
(Thresholds
invisible)
Alarm name:
O2 over set limit.

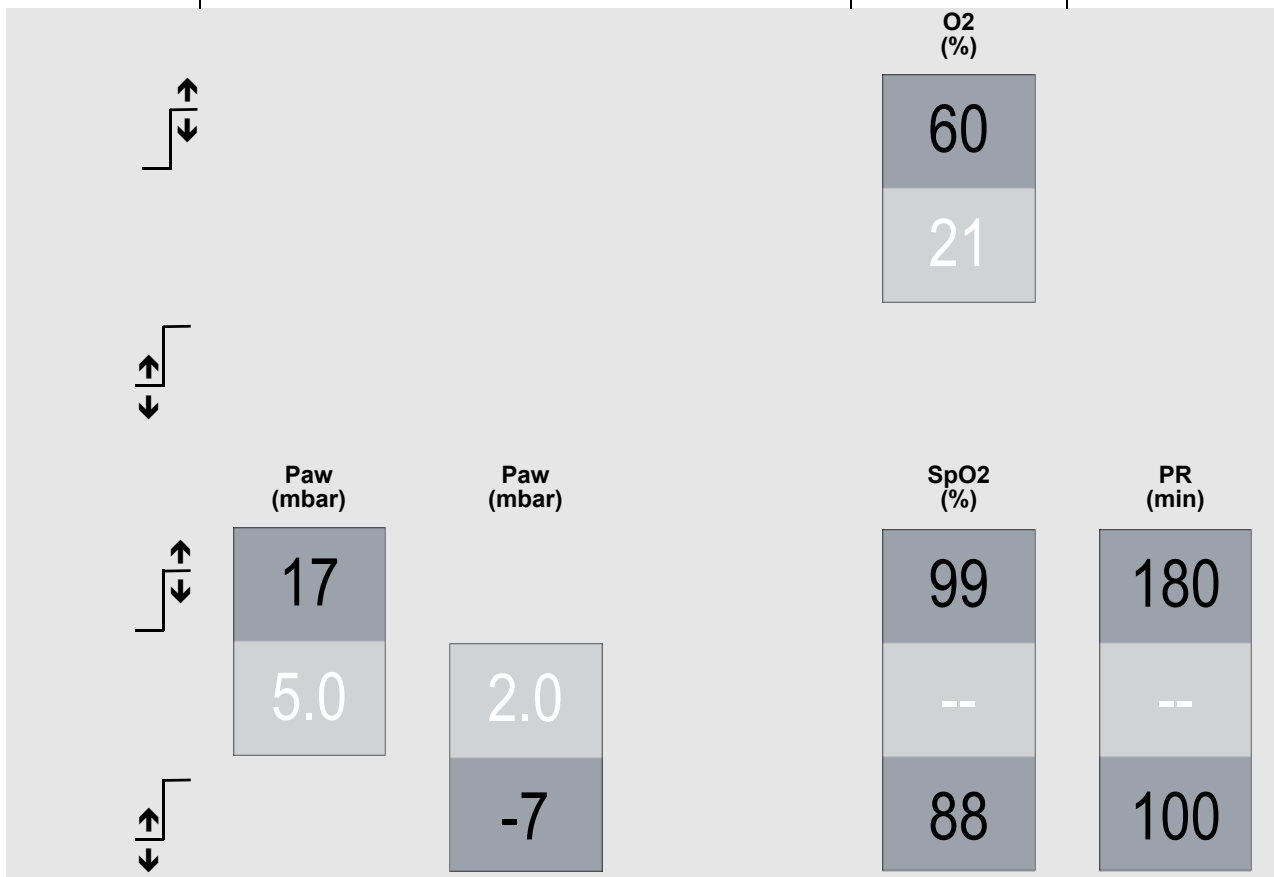

High Paw
Set maximum and
minimum
thresholds.
High Alarm name:
High Paw
(Threshold Visible).

Low Paw
Set maximum and
minimum
thresholds.
Low Alarm name:
Low Pressure
(Threshold Visible).



SpO2
Set maximum and
minimum SpO₂
thresholds. Only
active when SpO₂
module connected.



PR
Set maximum and
minimum pulse rate
thresholds. Only
active when SpO₂
module connected.

15.8 Common warnings

Warning: The ventilator must not be connected to the patient during the basic set-up procedure.

Warning: Do not enter the “Standby” mode when connected to a patient. No ventilation is delivered.

Warning: The user shall ensure that all the alarm thresholds are set to appropriate levels depending on patient condition.

15.9 Common cautions

Caution: The basic set-up routines described in this chapter are only to allow the user (i.e. clinician/medical staff) to enter each mode in a safe manner.

It is the responsibility of the user to set safe ventilation parameters. The ventilation parameters stated in this chapter are used only to guide the user, if the user deems these parameters unsuitable for the patient then appropriate parameters should be selected.

The ventilator may display the parameters as set by the user through the user preferences.

The parameters stated in this chapter should never override the user choice of ventilator settings.

Caution: The flow sensor is a serviceable item and may require cleaning during use.

15.9.1 Common alternate functions (Conventional ventilation)

Note: Alternative functions are only selected via the user preferences utility.

See “User preferences” on page 132.

15.9.1.1 Manual breath or Inspiratory hold

If a inspiratory hold time has been set in the user preferences the Manual Breath button is replaced by the Inspiratory Hold button. Pressing the button will initiate a breath up to the set inspiratory time. (this maximum time can be set to either 5 or 10 seconds). Releasing the button will end the breath. The inspiratory hold will use the set PIP.

15.9.1.2 O₂ Boost or O₂ suction

If this feature has been enabled the user can select when required O₂ Boost or O₂ suction through the O₂ parameter control.

15.9.2 Common alternate functions (High frequency ventilation)

15.9.2.1 Sigh or Sigh hold

If a Sigh hold time has been set in the user preferences the Sigh button is replaced by the Sigh Hold button. Pressing the button will initiate a Sigh breath up to the set inspiratory time. (this maximum time can be set to either 5 or 10 seconds). Releasing the button will end the breath. The inspiratory hold will use the set Sigh P.

15.9.2.2 O₂ Boost or O₂ suction

If this feature has been enabled the user can select when required O₂ Boost or O₂ suction through the O₂ parameter control.

15.10 Ventilation without a flow sensor

When using the ventilator without a flow sensor the following features will not be available.

VTV control

Alarm thresholds

Tidal volume (V_{te})High and low

Minute volume (V_{min})High and low

Leak (%).....Maximum

Waveforms and loops

Flow, Volume

Ventilation - Non-invasive

“Non-invasive - Dual limb”

“nCPAP D” on page 82



“NIPPV D” on page 84



“NIPPV Tr.” on page 86



“nHFOV” on page 88



“Non-invasive - Single limb”

“nCPAP S” on page 90



“DuoPAP” on page 92



“O2 therapy” on page 94





16. Non-invasive - Dual limb

16.1 nCPAP D





Mode type: Non-invasive.
Dual limb patient circuit.

Prior to and after connection, it is the user's responsibility to adjust and monitor the ventilation parameters.

<p>Additional Parameters Active for 120 seconds when mode selected.</p>	<p>RR backup Press and hold the control for 2 seconds to switch On/Off. Press confirm to acknowledge. (Default 40 BPM when On)</p>	<p>Rise time Alters the pressure wave shape.</p>		<p>Trigger sensitivity Set the breath trigger sensitivity. The default is 50%.</p>		
<p>Additional Parameters</p>	<p>RR Backup Off 1 BPM 150</p>	<p>Rise time 0.04 0.0 Seconds 3.0</p>		<p>Trig Sens 50 1 % 100</p>		
<p>Manual Breath</p>	<p>Ti 0.40 0.1 Seconds 3.0</p>		<p>CPAP 4.0 0.0 mbar 35.0</p>	<p>PIP 15 0 mbar 65</p>		<p>O2 21 21 % 100</p>
<p>Manual breath</p> <p>Alternate function Inspiratory hold</p>	<p>Ti Inspiratory time The inspiration time in seconds.</p> <p>Interactive controls A. The Ti control cannot be increased beyond the set RR backup rate. B. The RR backup rate control cannot be increased beyond the allowable Ti. C. The Rise time cannot be increased beyond the set Ti</p>		<p>CPAP Continuous positive airway pressure in mbar</p> <p>Interactive controls The CPAP control cannot be increased beyond the set PIP. The PIP cannot be decreased below the set CPAP.</p>	<p>PIP Peak inspiratory pressure in mbar. For manual and backup breaths.</p>		<p>O2 Oxygen concentration delivered to patient.</p> <p>Alternate function O2 Boost O2 suction</p>  <p>+</p>  <p>Auto O2</p>

Note. The above values are shown at their factory default settings.

<p>nCPAP D default alarm thresholds</p>	<p>RR Set maximum threshold. (Thresholds invisible) Alarm name: BPM too high</p>	 <p>O2 % Set maximum threshold. (Thresholds invisible) Alarm name: O2 over set limit.</p>																									
	<p>Apnoea Set maximum Apnoea time limit. Can be set to Off (See warning below) (Thresholds invisible) Alarm name: Period between patient effort exceeds apnoea limit</p>																										
<table border="1"> <tr> <td></td> <td colspan="2"> <p>RR (BPM)</p> <div style="display: flex; justify-content: space-around;"> <div style="border: 1px solid gray; padding: 5px; width: 40px; text-align: center;">100</div> <div style="border: 1px solid gray; padding: 5px; width: 40px; text-align: center;">0</div> </div> </td> <td colspan="2"> <p>O2 (%)</p> <div style="display: flex; justify-content: space-around;"> <div style="border: 1px solid gray; padding: 5px; width: 40px; text-align: center;">60</div> <div style="border: 1px solid gray; padding: 5px; width: 40px; text-align: center;">21</div> </div> </td> <td colspan="2"></td> </tr> <tr> <td></td> <td colspan="5" style="text-align: center;"> <p>Apnoea (seconds)</p> <div style="border: 1px solid gray; padding: 5px; width: 80px; margin: 0 auto; text-align: center;">15</div> </td> <td></td> </tr> <tr> <td></td> <td> <p>PIP (mbar)</p> <div style="display: flex; justify-content: space-around;"> <div style="border: 1px solid gray; padding: 5px; width: 40px; text-align: center;">20</div> <div style="border: 1px solid gray; padding: 5px; width: 40px; text-align: center;">15.0</div> <div style="border: 1px solid gray; padding: 5px; width: 40px; text-align: center;">11</div> </div> </td> <td> <p>CPAP (mbar)</p> <div style="display: flex; justify-content: space-around;"> <div style="border: 1px solid gray; padding: 5px; width: 40px; text-align: center;">7.0</div> <div style="border: 1px solid gray; padding: 5px; width: 40px; text-align: center;">4.0</div> <div style="border: 1px solid gray; padding: 5px; width: 40px; text-align: center;">1</div> </div> </td> <td> <p>SpO2 (%)</p> <div style="display: flex; justify-content: space-around;"> <div style="border: 1px solid gray; padding: 5px; width: 40px; text-align: center;">99</div> <div style="border: 1px solid gray; padding: 5px; width: 40px; text-align: center;">--</div> <div style="border: 1px solid gray; padding: 5px; width: 40px; text-align: center;">88</div> </div> </td> <td> <p>PR (min)</p> <div style="display: flex; justify-content: space-around;"> <div style="border: 1px solid gray; padding: 5px; width: 40px; text-align: center;">180</div> <div style="border: 1px solid gray; padding: 5px; width: 40px; text-align: center;">--</div> <div style="border: 1px solid gray; padding: 5px; width: 40px; text-align: center;">100</div> </div> </td> <td colspan="2"></td> </tr> </table>								<p>RR (BPM)</p> <div style="display: flex; justify-content: space-around;"> <div style="border: 1px solid gray; padding: 5px; width: 40px; text-align: center;">100</div> <div style="border: 1px solid gray; padding: 5px; width: 40px; text-align: center;">0</div> </div>		<p>O2 (%)</p> <div style="display: flex; justify-content: space-around;"> <div style="border: 1px solid gray; padding: 5px; width: 40px; text-align: center;">60</div> <div style="border: 1px solid gray; padding: 5px; width: 40px; text-align: center;">21</div> </div>					<p>Apnoea (seconds)</p> <div style="border: 1px solid gray; padding: 5px; width: 80px; margin: 0 auto; text-align: center;">15</div>							<p>PIP (mbar)</p> <div style="display: flex; justify-content: space-around;"> <div style="border: 1px solid gray; padding: 5px; width: 40px; text-align: center;">20</div> <div style="border: 1px solid gray; padding: 5px; width: 40px; text-align: center;">15.0</div> <div style="border: 1px solid gray; padding: 5px; width: 40px; text-align: center;">11</div> </div>	<p>CPAP (mbar)</p> <div style="display: flex; justify-content: space-around;"> <div style="border: 1px solid gray; padding: 5px; width: 40px; text-align: center;">7.0</div> <div style="border: 1px solid gray; padding: 5px; width: 40px; text-align: center;">4.0</div> <div style="border: 1px solid gray; padding: 5px; width: 40px; text-align: center;">1</div> </div>	<p>SpO2 (%)</p> <div style="display: flex; justify-content: space-around;"> <div style="border: 1px solid gray; padding: 5px; width: 40px; text-align: center;">99</div> <div style="border: 1px solid gray; padding: 5px; width: 40px; text-align: center;">--</div> <div style="border: 1px solid gray; padding: 5px; width: 40px; text-align: center;">88</div> </div>	<p>PR (min)</p> <div style="display: flex; justify-content: space-around;"> <div style="border: 1px solid gray; padding: 5px; width: 40px; text-align: center;">180</div> <div style="border: 1px solid gray; padding: 5px; width: 40px; text-align: center;">--</div> <div style="border: 1px solid gray; padding: 5px; width: 40px; text-align: center;">100</div> </div>		
	<p>RR (BPM)</p> <div style="display: flex; justify-content: space-around;"> <div style="border: 1px solid gray; padding: 5px; width: 40px; text-align: center;">100</div> <div style="border: 1px solid gray; padding: 5px; width: 40px; text-align: center;">0</div> </div>		<p>O2 (%)</p> <div style="display: flex; justify-content: space-around;"> <div style="border: 1px solid gray; padding: 5px; width: 40px; text-align: center;">60</div> <div style="border: 1px solid gray; padding: 5px; width: 40px; text-align: center;">21</div> </div>																								
	<p>Apnoea (seconds)</p> <div style="border: 1px solid gray; padding: 5px; width: 80px; margin: 0 auto; text-align: center;">15</div>																										
	<p>PIP (mbar)</p> <div style="display: flex; justify-content: space-around;"> <div style="border: 1px solid gray; padding: 5px; width: 40px; text-align: center;">20</div> <div style="border: 1px solid gray; padding: 5px; width: 40px; text-align: center;">15.0</div> <div style="border: 1px solid gray; padding: 5px; width: 40px; text-align: center;">11</div> </div>	<p>CPAP (mbar)</p> <div style="display: flex; justify-content: space-around;"> <div style="border: 1px solid gray; padding: 5px; width: 40px; text-align: center;">7.0</div> <div style="border: 1px solid gray; padding: 5px; width: 40px; text-align: center;">4.0</div> <div style="border: 1px solid gray; padding: 5px; width: 40px; text-align: center;">1</div> </div>	<p>SpO2 (%)</p> <div style="display: flex; justify-content: space-around;"> <div style="border: 1px solid gray; padding: 5px; width: 40px; text-align: center;">99</div> <div style="border: 1px solid gray; padding: 5px; width: 40px; text-align: center;">--</div> <div style="border: 1px solid gray; padding: 5px; width: 40px; text-align: center;">88</div> </div>	<p>PR (min)</p> <div style="display: flex; justify-content: space-around;"> <div style="border: 1px solid gray; padding: 5px; width: 40px; text-align: center;">180</div> <div style="border: 1px solid gray; padding: 5px; width: 40px; text-align: center;">--</div> <div style="border: 1px solid gray; padding: 5px; width: 40px; text-align: center;">100</div> </div>																							
<p>Warning: Ventilation with the Apnoea alarm "OFF" The user must use an alternative method of detecting an apnoeic episode, with the Apnoea alarm turned "OFF"</p>	<p>PIP Set maximum and minimum thresholds. High Alarm name: PIP too high (Threshold Visible) Low Alarm name: PIP too low (Threshold Invisible)</p>	<p>CPAP Set maximum and minimum thresholds. High Alarm name: PEEP too high (Threshold Invisible) Low Alarm name: Pressure below low threshold (Threshold Visible)</p>	 <p>SpO2 Set maximum and minimum SpO2 thresholds. Only active when SpO2 module connected.</p>	 <p>PR Set maximum and minimum pulse rate thresholds. Only active when SpO2 module connected.</p>																							

16.2 NIPPV D



Mode type: Non-invasive.
Dual limb patient circuit.

Prior to and after connection, it is the user's responsibility to adjust and monitor the ventilation parameters.

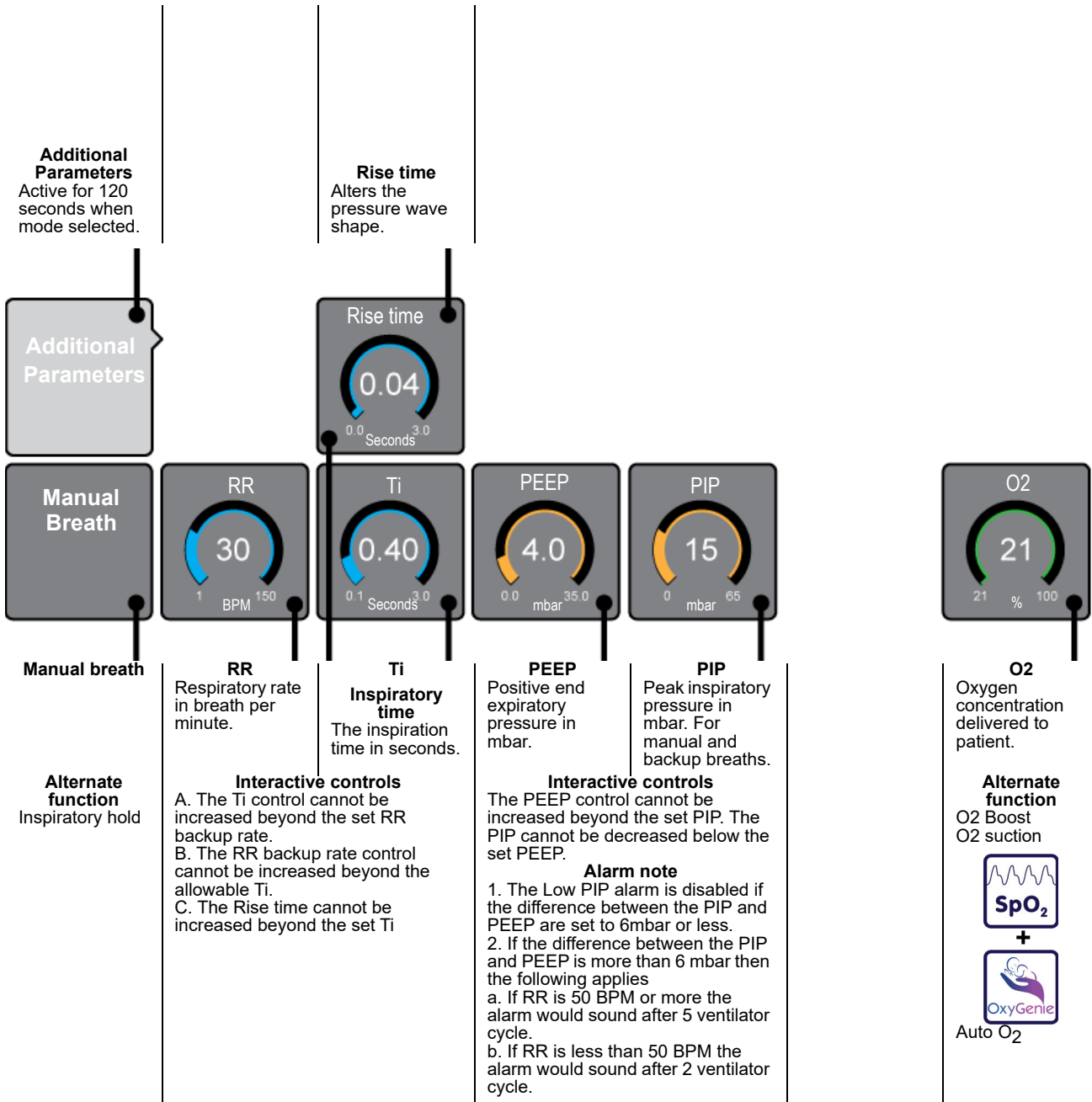

Note. The above values are shown at their factory default settings.

**NIPPV D
default alarm
thresholds**



O2 %
Set maximum
threshold.
(Thresholds
invisible)
Alarm name:
O2 over set limit.

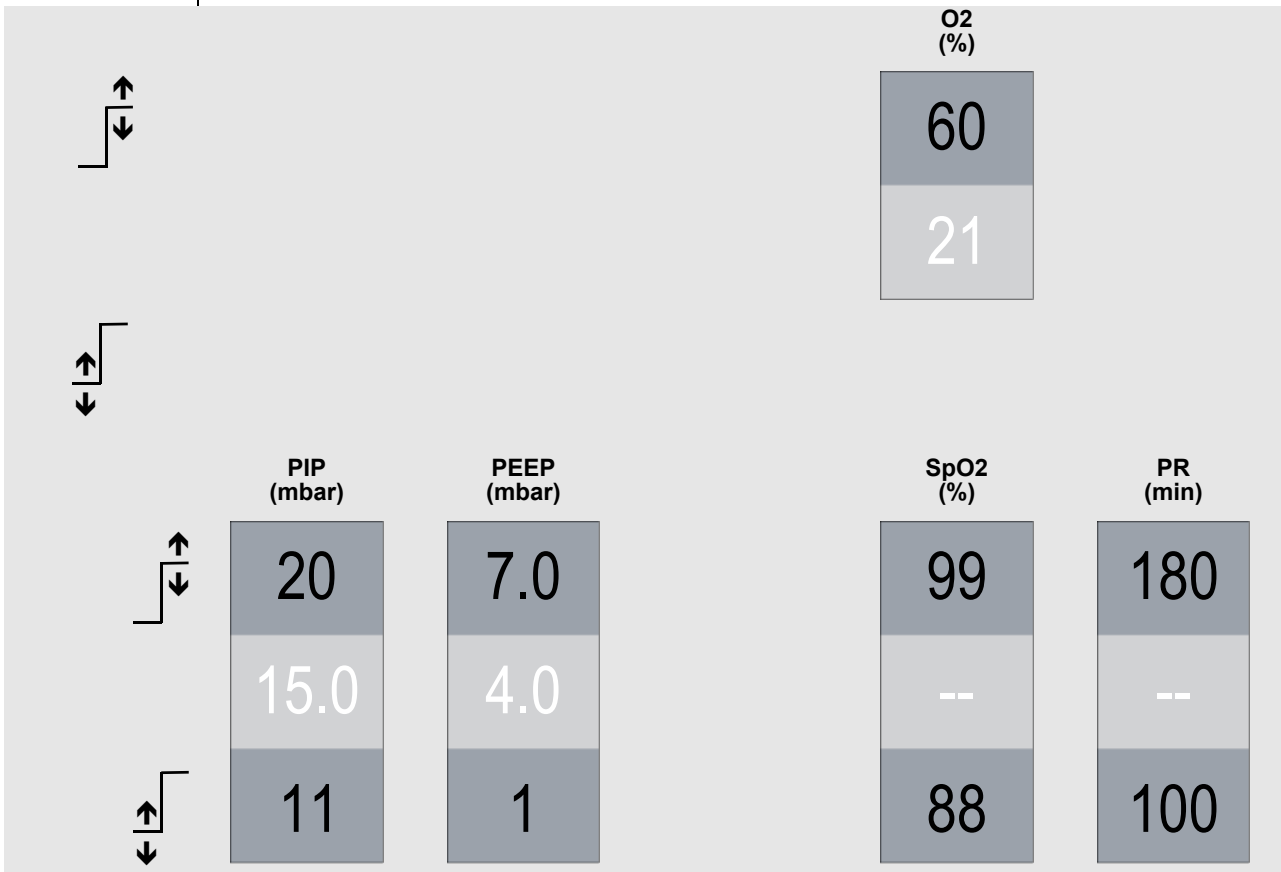

PIP
Set maximum and
minimum
thresholds.
High Alarm name:
PIP too high
(Threshold Visible)
Low Alarm name:
PIP too low
(Threshold
Invisible)

PEEP
Set maximum and
minimum
thresholds.
High Alarm name:
PEEP too high
(Threshold
Invisible)
Low Alarm name:
Pressure below low
threshold
(Threshold Visible)



SpO2
Set maximum and
minimum SpO2
thresholds. Only
active when SpO2
module connected.





PR
Set maximum and
minimum pulse rate
thresholds. Only
active when SpO2
module connected.

16.3 NIPPV Tr.









Mode type: Non-invasive.
Dual limb patient circuit.

Prior to and after connection, it is the user's responsibility to adjust and monitor the ventilation parameters.

<p>Additional Parameters Active for 120 seconds when mode selected.</p>						<p>Rise time Alters the pressure wave shape.</p>				<p>Trigger sensitivity Set the breath trigger sensitivity. The default is 50%.</p>		
<p>Additional Parameters</p>						<p>Rise time 0.04 0.0 Seconds 3.0</p>				<p>Trig Sens 50 1 % 100</p>		
<p>Manual Breath</p>	<p>RR 30 1 BPM 150</p>	<p>Ti 0.40 0.1 Seconds 3.0</p>	<p>PEEP 4.0 0.0 mbar 35.0</p>	<p>PIP 15 0 mbar 65</p>				<p>O2 21 21 % 100</p>				
<p>Manual breath</p>	<p>RR Respiratory rate in breath per minute.</p>	<p>Ti Inspiratory time The inspiration time in seconds.</p>	<p>PEEP Positive end expiratory pressure in mbar</p>	<p>PIP Peak inspiratory pressure in mbar. For manual and backup breaths.</p>				<p>O2 Oxygen concentration delivered to patient.</p>				
<p>Alternate function Inspiratory hold</p>	<p>Interactive controls A. The Ti control cannot be increased beyond the set RR backup rate. B. The RR backup rate control cannot be increased beyond the allowable Ti. C. The Rise time cannot be increased beyond the set Ti</p>		<p>Interactive controls The PEEP control cannot be increased beyond the set PIP. The PIP cannot be decreased below the set PEEP.</p> <p>Alarm note 1. The Low PIP alarm is disabled if the difference between the PIP and PEEP are set to 6mbar or less. 2. If the difference between the PIP and PEEP is more than 6 mbar then the following applies a. If RR is 50 BPM or more the alarm would sound after 5 ventilator cycle. b. If RR is less than 50 BPM the alarm would sound after 2 ventilator cycle.</p>					<p>Alternate function O2 Boost O2 suction</p>  <p>+</p>  <p>Auto O₂</p>				

Note. The above values are shown at their factory default settings.

<p>NIPPV Tr. default alarm thresholds</p>	<p>RR Set maximum threshold. (Thresholds invisible) Alarm name: BPM too high</p> <p>Apnoea Set max Apnoea time limit. Set to Off as default (See warning below) (Thresholds invisible) Alarm name: Period between patient effort exceeds apnoea limit.</p>	<p>O2 % Set maximum threshold. (Thresholds invisible) Alarm name: O2 over set limit.</p>		
   	<p>RR (BPM)</p> <p>100</p> <p>0</p> <p>Apnoea (seconds)</p> <p>OFF</p> <p>PIP (mbar)</p> <p>20</p> <p>15.0</p> <p>11</p> <p>PEEP (mbar)</p> <p>7.0</p> <p>4.0</p> <p>1</p>	<p>O2 (%)</p> <p>60</p> <p>21</p>	<p>SpO2 (%)</p> <p>99</p> <p>--</p> <p>88</p>	<p>PR (min)</p> <p>180</p> <p>--</p> <p>100</p>
<p>Warning: Ventilation with the Apnoea alarm "OFF" The user must use an alternative method of detecting an apnoeic episode, with the Apnoea alarm turned "OFF"</p>	<p>PIP Set maximum and minimum thresholds. High Alarm name: PIP too high (Threshold Visible) Low Alarm name: PIP too low (Threshold Invisible)</p>	<p>PEEP Set maximum and minimum thresholds. High Alarm name: PEEP too high (Threshold Invisible) Low Alarm name: Pressure below low threshold (Threshold Visible)</p>	 <p>SpO2 Set maximum and minimum SpO2 thresholds. Only active when SpO2 module connected.</p>	 <p>PR Set maximum and minimum pulse rate thresholds. Only active when SpO2 module connected.</p>

16.4 nHFOV



Mode type: Non-invasive. Dual limb patient circuit. Prior to and after connection, it is the user's responsibility to adjust and monitor the ventilation parameters.

<p>Oscillation Pause The oscillations can be paused for 60 seconds by pressing the oscillation paused button. Press and hold the control for 1 seconds to switch On/Off.</p>	<p>Interactive controls The sigh RR cannot be increased beyond the limit dictated by the set sigh inspiratory time. The sigh inspiratory time cannot be increased beyond the limit set by the set sigh RR.</p>	<p>Sigh P Sets the inspiratory pressure for the sigh breath.</p>
<p>Additional Parameters Active for 120 seconds when mode selected.</p>	<p>Sigh RR Press and hold the control for 2 seconds to switch On/Off. Press confirm to acknowledge. (Default 30 BPM when On). Sets the respiratory rate for the sigh breaths.</p>	<p>Sigh Ti Sets the inspiratory time for the sigh breath.</p>

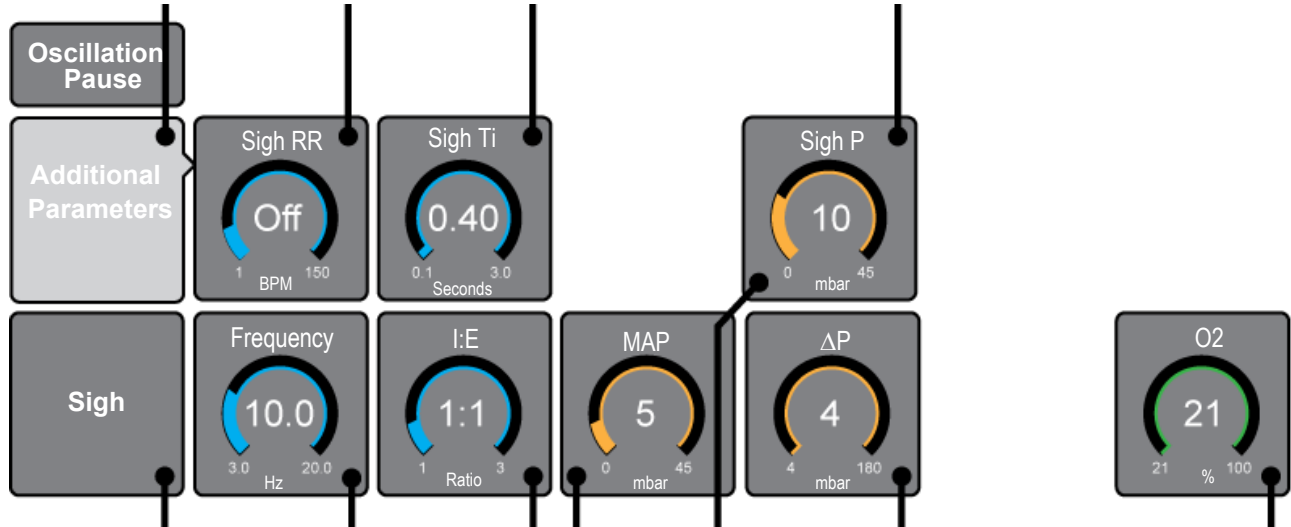

<p>Sigh* The sigh control will initiate a pause at the set Sigh Ti. Alternate function Sigh hold</p>	<p>Frequency HFO frequency in Hertz (Hz)</p>	<p>I:E Ratio for inspiration to expiration (1:1, 1:2 & 1:3)</p>	<p>MAP Mean airway pressure in mbar</p>	<p>ΔP Delta pressure in mbar.</p>	<p>O2 Oxygen concentration delivered to patient.</p>
---	---	--	--	--	---

Interactive controls
The Sigh Hold will use the user preference set 5 or 10 second pause.

Caution*: With the Sigh RR set to Off the Sigh Ti can be set anywhere between 0.1 and 3 seconds for manual Sigh's. When Sigh RR is subsequently turned on the Sigh Ti could be incompatible with the set Sigh RR. The user will have to adjust the Sigh Ti or the Sigh RR accordingly.

Interactive controls
MAP and Sigh P
A. The MAP control will automatically start to increase the Sigh P when it passes the set level of Sigh P and the Sigh P will track the MAP.
B. If the MAP is decreased the Sigh P will remain at the new level. In this case the difference between MAP and Sigh P can be greater than 15 mbar.
C. The Sigh P cannot be decreased below the set MAP.
D. The Sigh P can be increased independently of the set MAP but only 15 mbar above the set MAP.

Note. The above values are shown at their factory default settings.

O2
Oxygen concentration delivered to patient.
Alternate function
O2 Boost
O2 suction



+



Auto O₂

nHFOV
default alarm
thresholds



O2 %
Set maximum
threshold.
(Thresholds
invisible)
Alarm name:
O2 over set limit.

			O2 (%)	
			60	
			21	
	Paw (mbar)	Paw (mbar)	SpO2 (%)	PR (min)
	17		99	180
	5.0	2.0	--	--
		-7	88	100

High Paw
Set maximum and
minimum
thresholds.
High Alarm name:
High Paw
(Threshold Visible)

Low Paw
Set maximum and
minimum
thresholds.
Low Alarm name:
Low Pressure
(Threshold Visible)



SpO2
Set maximum and
minimum SpO2
thresholds. Only
active when SpO2
module connected.



PR
Set maximum and
minimum pulse rate
thresholds. Only
active when SpO2
module connected.



17. Non-invasive - Single limb

17.1 nCPAP S

Mode type: Non-Invasive Single limb patient circuit.



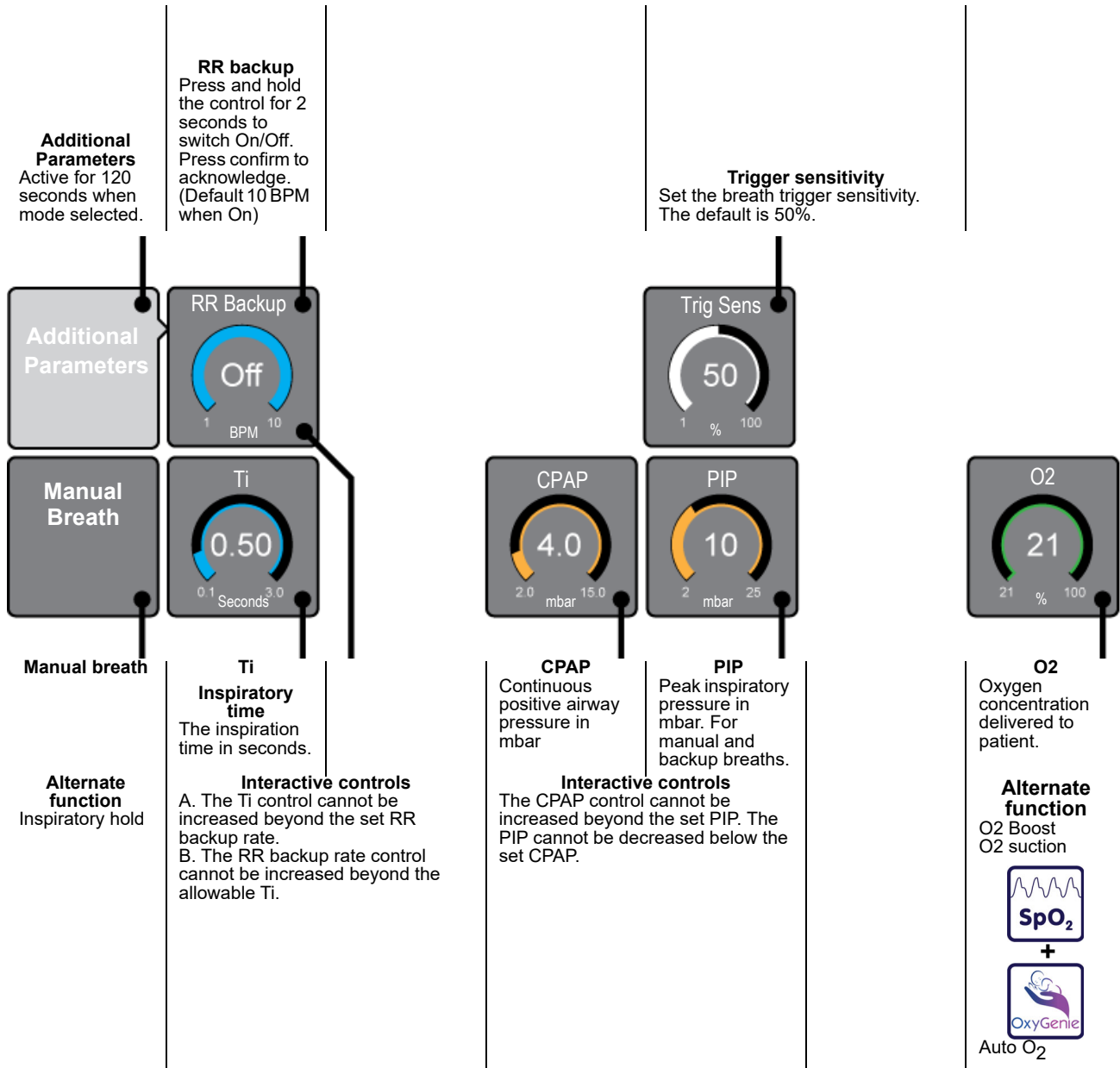



Prior to and after connection, it is the user's responsibility to adjust and monitor the ventilation parameters.



Warning: When using Small or Extra Small nasal prongs during CPAP, the Ventilator may not raise an alarm if a patient disconnection occurs. It is recommended that back-up breaths are always turned on as this will deliver back up breaths and alert the user to a low PIP condition if the nasal prongs become detached. Only the monitoring of SpO₂, or of transcutaneous Oxygen and Carbon Dioxide will dependably alert the medical team to a patient disconnection.

Note. The above values are shown at their factory default settings.

Note: Application of the prongs/mask are not covered in this manual. Please refer to the instruction for use supplied with the nCPAP generator.

<p>nCPAP S default alarm thresholds</p>		<p>RR Set maximum threshold. (Thresholds invisible) Alarm name: BPM too high</p>			
		<p>Apnoea Set maximum Apnoea time limit. Can be set to Off (See warning below) (Thresholds invisible) Alarm name: Period between patient effort exceeds apnoea limit</p>		 <p>O2 % Set maximum threshold. (Thresholds invisible) Alarm name: O2 over set limit.</p>	
   			<p>RR (BPM)</p> <div style="border: 1px solid gray; padding: 5px; text-align: center;"> <p>100</p> <hr style="border: 0; border-top: 1px solid gray;"/> <p>0</p> </div> <p>Apnoea (seconds)</p> <div style="border: 1px solid gray; padding: 5px; text-align: center;"> <p>15</p> </div>	<p>O2 (%)</p> <div style="border: 1px solid gray; padding: 5px; text-align: center;"> <p>60</p> <hr style="border: 0; border-top: 1px solid gray;"/> <p>21</p> </div>	<p>PIP (mbar)</p> <div style="border: 1px solid gray; padding: 5px; text-align: center;"> <p>15</p> <hr style="border: 0; border-top: 1px solid gray;"/> <p>15.0</p> <hr style="border: 0; border-top: 1px solid gray;"/> <p>8</p> </div> <p>CPAP (mbar)</p> <div style="border: 1px solid gray; padding: 5px; text-align: center;"> <p>9</p> <hr style="border: 0; border-top: 1px solid gray;"/> <p>4.0</p> <hr style="border: 0; border-top: 1px solid gray;"/> <p>1</p> </div> <p>SpO2 (%)</p> <div style="border: 1px solid gray; padding: 5px; text-align: center;"> <p>99</p> <hr style="border: 0; border-top: 1px solid gray;"/> <p>--</p> <hr style="border: 0; border-top: 1px solid gray;"/> <p>88</p> </div> <p>PR (min)</p> <div style="border: 1px solid gray; padding: 5px; text-align: center;"> <p>180</p> <hr style="border: 0; border-top: 1px solid gray;"/> <p>--</p> <hr style="border: 0; border-top: 1px solid gray;"/> <p>100</p> </div>
<p>Warning: Ventilation with the Apnoea alarm "OFF" The user must use an alternative method of detecting an apnoeic episode, with the Apnoea alarm turned "OFF"</p>	<p>PIP Set maximum and minimum thresholds. High Alarm name: PIP too high (Threshold Visible) Low Alarm name: PIP too low (Threshold Invisible)</p>	<p>CPAP Set maximum and minimum thresholds. High Alarm name: PEEP too high (Threshold Invisible) Low Alarm name: Pressure below low threshold (Threshold Visible)</p>		 <p>SpO2 Set maximum and minimum SpO2 thresholds. Only active when SpO2 module connected.</p>	 <p>PR Set maximum and minimum pulse rate thresholds. Only active when SpO2 module connected.</p>

17.2 DuoPAP



**Mode type: Non-invasive.
Single limb patient circuit.**

Prior to and after connection, it is the user's responsibility to adjust and monitor the ventilation parameters.

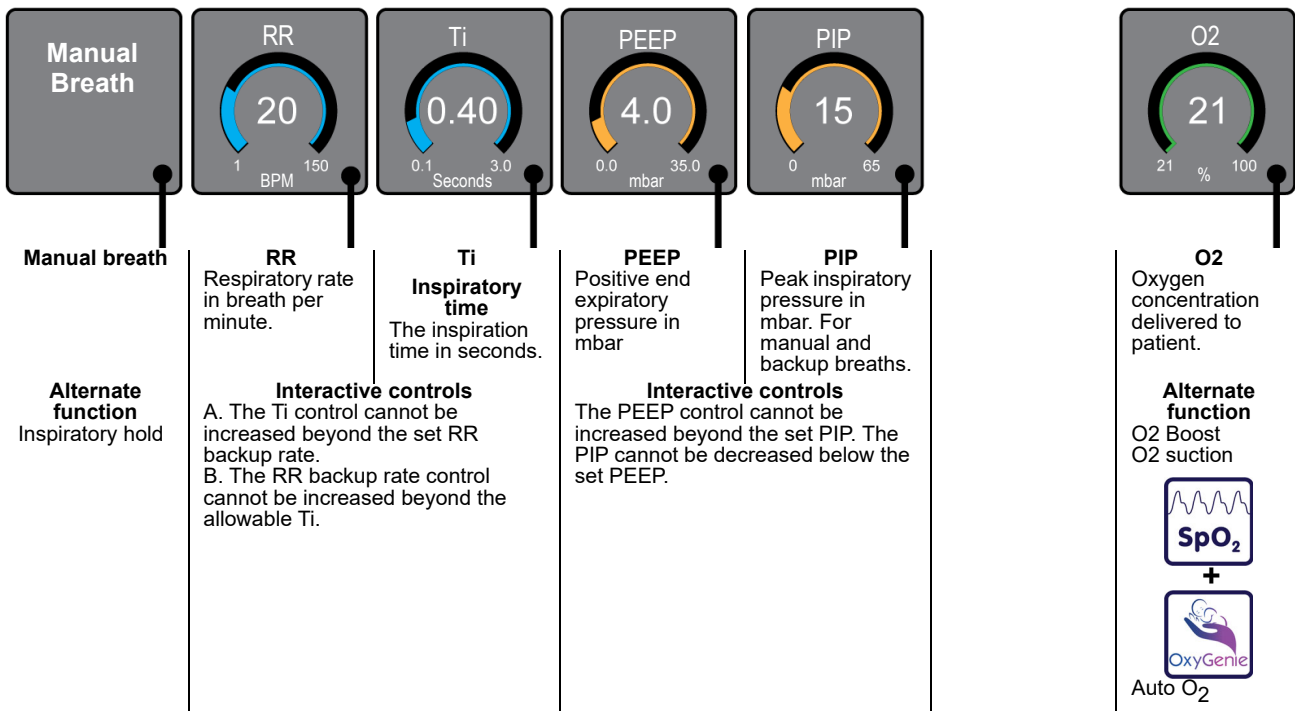

Note. The above values are shown at their factory default settings.

Note: Application of the prongs/mask are not covered in this manual. Please refer to the instruction for use supplied with the nCPAP generator.

DuoPAP
default alarm
thresholds



O2 %
Set maximum
threshold.
(Thresholds
invisible)
Alarm name:
O2 over set limit.

	PIP (mbar)	PEEP (mbar)	SpO2 (%)	PR (min)
	20	7.0	99	180
	15.0	4.0	--	--
	11	1	88	100
	<p>PIP Set maximum and minimum thresholds. High Alarm name: PIP too high (Threshold Visible) Low Alarm name: PIP too low (Threshold Invisible)</p>	<p>PEEP Set maximum and minimum thresholds. High Alarm name: PEEP too high (Threshold Invisible) Low Alarm name: Pressure below low threshold (Threshold Visible)</p>	<p> SpO2 Set maximum and minimum SpO2 thresholds. Only active when SpO2 module connected.</p>	<p> PR Set maximum and minimum pulse rate thresholds. Only active when SpO2 module connected.</p>

17.3 O2 therapy



Mode type: Non-invasive.
Single limb patient circuit.

Prior to and after connection, it is the user's responsibility to adjust and monitor the ventilation parameters.

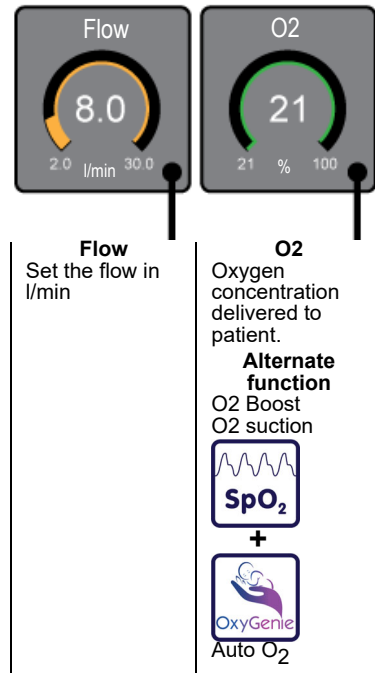

Note. The above values are shown at their factory default settings.

Note: O2 therapy has no alarms thresholds when used without the SpO₂ module

Note: O2 therapy mode displays the O2 (%) trend by default.

Note: The O2 (%) trend will not display any reading during the automatic oxygen calibration routine.

**O2 Therapy
default alarm
thresholds**



O2 %
Set maximum
threshold.
(Thresholds
invisible)
Alarm name:
O2 over set limit.

	O2 (%)	
	60	21
	SpO2 (%)	PR (min)
	99	180
	--	--
	88	100



SpO2
Set maximum and
minimum SpO2
thresholds. Only
active when SpO2
module connected.



PR
Set maximum and
minimum pulse rate
thresholds. Only
active when SpO2
module connected.

17.4 Common warnings

Warning: The ventilator must not be connected to the patient during the basic set-up procedure.

Warning: Do not enter the “Standby” mode when connected to a patient. No ventilation is delivered.

Warning: The user shall ensure that all the alarm thresholds are set to appropriate levels depending on patient condition.

17.5 Common cautions

Caution. The basic set-up routines described in this chapter are only to allow the user (i.e. clinician/medical staff) to enter each mode in a safe manner.

It is the responsibility of the user to set safe ventilation parameters. The ventilation parameters stated in this chapter are used only to guide the user, if the user deems these parameters unsuitable for the patient then appropriate parameters should be selected.

The ventilator may display the parameters as set by the user through the user preferences.

The parameters stated in this chapter should never override the user choice of ventilator settings.

17.6 Common note

Note: All non-invasive modes are used without a flow sensor. If the flow sensor is connected please disconnect it prior to set up.

SpO₂ and etCO₂ monitoring

“SpO₂ monitoring (Masimo SET)” on page 98



“EtCO₂ monitoring (MicroPod™)” on page 104

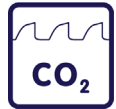

18. SpO₂ and etCO₂ monitoring

18.1 SpO₂ monitoring (Masimo SET)



The pulse oximeter is to be operated by, or under the supervision of, qualified personnel only. The manual, accessories, directions for use, all precautionary information, and specifications should be read before use.

18.1.1 Principle of Operation

The Masimo SET[®] pulse oximeter is based on three principles:

1. Oxyhemoglobin and deoxyhemoglobin differ in their absorption of red and infrared light (spectrophotometry).
2. The volume of arterial blood in tissue and the light absorbed by the blood changes during the pulse (plethysmography).
3. Arterio-venous shunting is highly variable and that fluctuating absorbance by venous blood is a major component of noise during the pulse.

The Masimo SET pulse oximeter as well as traditional pulse oximetry determines SpO₂ by passing red and infrared light into a capillary bed and measuring changes in light absorption during the pulsatile cycle. Red and infrared light-emitting diodes (LEDs) in oximetry sensors serve as the light sources, a photodiode serves as the photodetector.

Traditional pulse oximetry assumes that all pulsations in the light absorbance signal are caused by oscillations in the arterial blood volume. This assumes that the blood flow in the region of the sensor passes entirely through the capillary bed rather than through any arterio-venous shunts. The traditional pulse oximeter calculates the ratio of pulsatile absorbance (AC) to the mean absorbance (DC) at each of two wavelengths, 660 nm and 905 nm:

$$S(660) = AC(660)/DC(660)$$

$$S(905) = AC(905)/DC(905)$$

The oximeter then calculates the ratio of these two arterial pulse-added absorbance signals:

$$R = S(660)/S(905)$$

This value of R is used to find the saturation SpO₂ in a look-up table built into the oximeter's software. The values in the look-up table are based upon human blood studies against a laboratory co-oximeter on healthy adult volunteers in induced hypoxia studies.

The Masimo SET pulse oximeter assumes that arterio-venous shunting is highly variable and that fluctuating absorbance by venous blood is the major component of noise during the pulse. decomposes S(660) and S(905) into an arterial signal plus a noise component and calculates the ratio of the arterial signals without the noise:

$$S(660) = S1 + N1$$

$$S(905) = S2 + N2$$

$$R = S1/S2$$

Again, R is the ratio of two arterial pulse-added absorbance signals and its value is used to find the saturation SpO₂ in an empirically derived equation into the oximeter's software. The values in the empirically derived equation are based upon human blood studies against a laboratory co-oximeter on healthy adult volunteers in induced hypoxia studies. The above equations are combined and a noise reference (N') is determined:

$$N' = S(660) - S(905) \times R$$

If there is no noise N' = 0: then S(660) = S(905) x R which is the same relationship for the traditional pulse oximeter.

The equation for the noise reference is based on the value of R, the value being sought to determine the SpO₂. The software sweeps through possible values of R that correspond to SpO₂ values between 1% and 100% and generates an N' value for each of these R-values.

The S(660) and S(905) signals are processed with each possible N' noise reference through an adaptive correlation canceler (ACC) which yields an output power for each possible value of R (i.e., each possible SpO₂ from 1% to 100%). The result is a Discrete Saturation Transform (DST[™]) plot of relative output power versus possible SpO₂ value as shown in the following figure where R corresponds to SpO₂ = 97%:

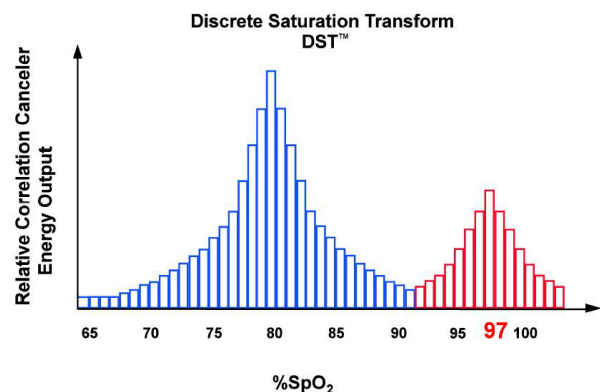

18.2 Masimo SET® Connection

18.2.1 Connection to ventilator

Insert the Medi snap connector of the Oximetry Cable into the SpO₂ socket on the rear of the ventilator. (Red socket).

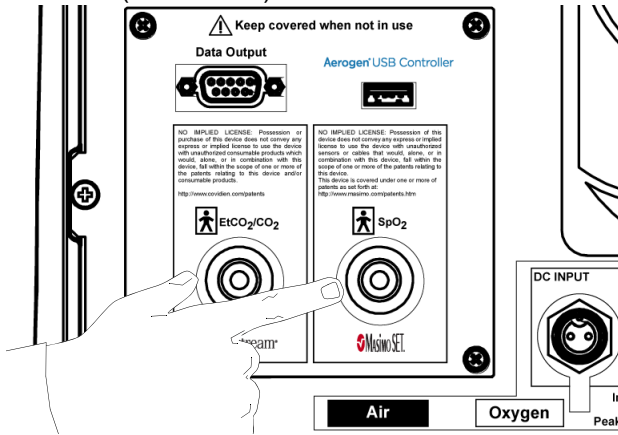

18.2.2 Disconnection

The sensor cable can be disconnected at anytime. The monitoring function can be turned OFF before or after disconnection in the sensor panel or the user can press “Continue without SpO₂” button in the alarm message bar.

18.2.3 Selection of Masimo SET® Sensors

The ventilator is currently designed to be used with the following 3 sensors.

Masimo NeoPt-3
SLE P/N^o: LSP02/2321

Masimo Neo-3
SLE P/N^o: LSP02/2320

Masimo Inf-3
SLE P/N^o: LSP02/2319

Masimo Pdtx-3
Only available from Masimo Corp.

Caution. Please refer to the instruction for use supplied with the sensors for size selection and application.

18.2.4 Sensor application sites

Site Selection

Always choose a site that is well perfused and will completely cover the sensor's detector window. Site should be cleaned of debris and dry prior to sensor placement.

NeoPt-3 Preterm Sensors

< 1 kg The preferred site is the foot. Alternatively, across the palm and back of the hand can be used.

Neo-3 Neonatal/Adult Sensors

< 3 kg The preferred site is the foot. Alternatively, across the palm and back of the hand can be used.
> 40 kg The preferred site is the middle or ring finger of non-dominant hand.

Inf-3 Infant Sensors

3–20 kg The preferred site is the great toe. Alternatively, the toe next to the great toe, or the thumb can be used.

Pdtx-3 Paediatric

10–50 kg The preferred site is the middle or ring finger of non dominant hand.

Caution: The ventilator intended use is for for premature neonates greater than 0.3kg, term neonates and infants, as well as paediatric patients up to 30kg depending on condition.

18.2.5 Connection of a sensor

Firmly insert the 9-pin sensor connector to the Oximetry Cable 9-pin receptacle shroud.

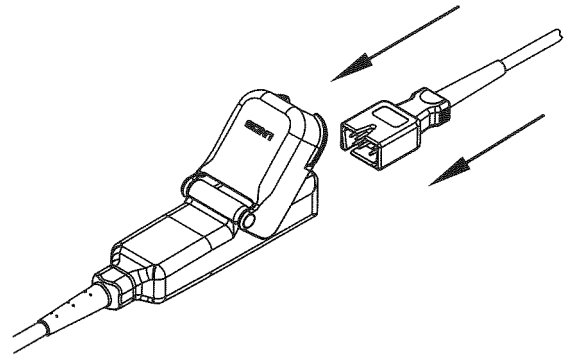

Rotate the clear latch over the mated connector until it snaps into place.

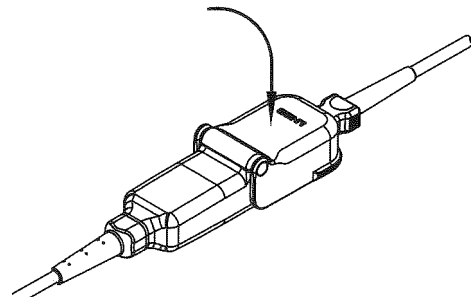

18.2.6 Disconnection

To disconnect the sensor, reverse the above steps.

18.3 Configuration

Select the utilities panel, this will now show the sensor tab then select the SpO₂ button.

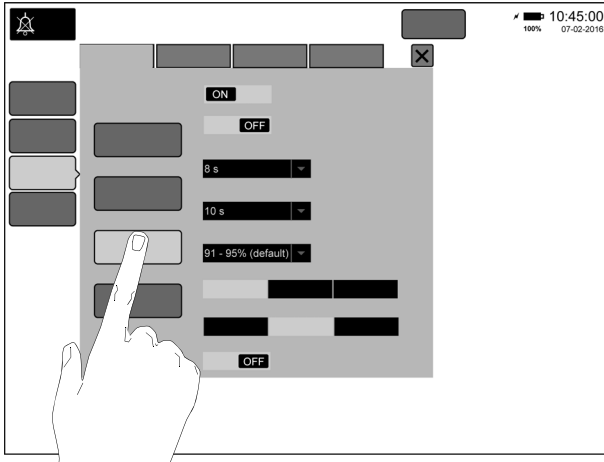

18.3.1 SpO₂ monitoring ON/OFF

This button will turn the SpO₂ monitoring function ON or OFF.

Note: This does not turn OFF the sensor. When OFF, the displayed SpO₂ value, trend and associated alarms are disabled.

18.3.2 FastSat™

FastSat™ enables rapid response to, and display of, fast changes in SpO₂ by giving priority to the most recent data.

Caution. FastSat™ is not recommended for routine use as there may be an increase of the frequency of alarms caused by rapid, transitory SpO₂ changes.

18.3.3 Averaging Time

The user-selectable averaging feature allows the clinician to select the desired level of visibility to subtle variations in the measured value.

*2-4 seconds

4-6 seconds

8 (Default) seconds

10 seconds

12 seconds

14 seconds

16 seconds.

*The averaging time is fixed to 2-4 seconds when OxyGenie® is on.

18.3.4 Alarm Delay

User Selectable Settings (seconds):

0

5

10 (Default)

15

18.3.5 Auto O₂: SpO₂ Target range limits.

This option allows the user to pre select one of four pre defined target ranges high and low alarm limits for OxyGenie®.

90-94%

91-95% (Default¹)

92-96%

94-98%

For normal SpO₂ monitoring the alarm limits are set at 99%² for the high and 88%² for the low.

¹The default can be user set to any of the four ranges via user preferences. See "Parameters tab" on page 266.

²The default high and low values can be use via set user preferences. See "Alarms tab" on page 267.

18.3.6 SpO₂ Sensitivity

The sensitivity mode setting allows the clinician to adapt the SpO₂ measurement sensitivity to the patient's level of SpO₂ signal strength and quality at the measurement site.

Normal Sensitivity is the recommended for patients who are experiencing some compromise in blood flow or perfusion. It is advisable for care areas where patients are observed frequently, such as the intensive care unit (ICU).

APOD (Adaptive Probe Off Detection) APOD Sensitivity is the recommended sensitivity mode where there is a high probability of the sensor becoming detached. It is also the suggested mode for care areas where patients are not visually monitored continuously. This mode delivers enhanced protection against erroneous pulse rate and arterial oxygen saturation readings when a sensor becomes inadvertently detached from a patient due to excessive movement.

Maximum Sensitivity (MAX) is recommended for use on patients with weak signals (e.g. high ambient noise and/or patients with very low perfusion) and for use during procedures or when clinician and patient contact is continuous such as in higher acuity settings.

18.3.7 Rapid Desat

The Rapid Desat Alarm is a user-selectable setting to allow a clinician to tell the monitor to override the audible alarm delay when the SpO₂ value exceeds the alarm limit threshold by a user-selectable %

User Selectable Settings:

5% (Default)

10%

Off

18.3.8 Perf Index

This button will turn the Perfusion Index function ON or OFF in the waveform window.

Perfusion Index is a value that indicates arterial pulse signal strength as the percentage of pulsatile signal to non-pulsatile signal.

18.4 Monitored values

SpO₂ in percent will be displayed in the bottom section of the monitored values panel. Circled in the above illustration.

PR (Pulse rate) is displayed in the top right of the SpO₂ waveform.

PI (Perfusion Index) when turned On will appear next to PR value.

18.5 SpO₂ alarms thresholds

When SpO₂ monitoring is turned on the following two high and low alarm thresholds become active in the Alarm Limits panel.

SpO₂% and PR (/min).

18.6 SpO₂ Waveform and display options

The SLE6000 displays the Pleth (Plethysmograph) waveform and the SIQ (Signal Identification and Quality) indicator waveform.

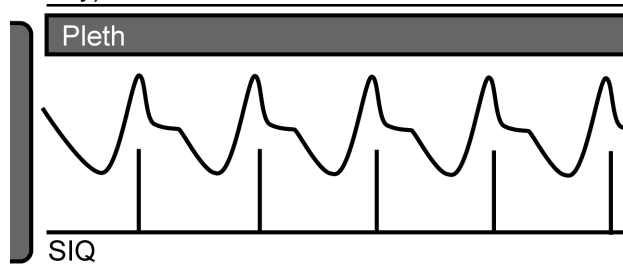

The Pleth waveform is displayed in the real time.

This SIQ indicator waveform shows the acquired measurement confidence and timing of each detected pulse relative to the Pleth. The ventilator displays the indicator waveform as a vertical line. The taller the line the better the signal quality, as the quality drops the line decreases in height. The quality is also indicated by a good quality signal being coloured blue and a poor quality signal being coloured orange.

The SIQ indicator waveform is not normalized.

Also displayed is the Pulse Rate PR and Perfusion index PI. The Pulse rate is always displayed but the Perfusion Index is only displayed when turned on from the SpO₂ sensor panel.

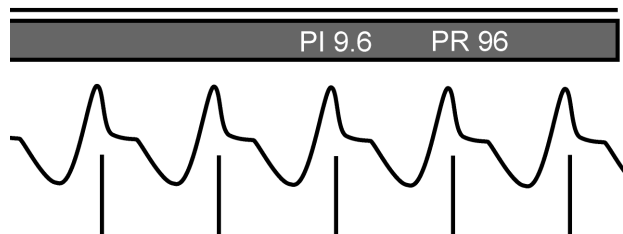

For SpO₂ the user has a choice of two layouts.

Layout 1: "Waveforms" which is standard three ventilation waveforms Pressure, Flow & Volume with the addition of SpO₂

Layout 2: "SpO₂" which is one ventilation waveform (Pressure, Flow or Volume) plus Pleth/SIQ SpO₂ and Set O₂.

18.7 Standard Waveform display option

From the Layout panel select Waveforms.

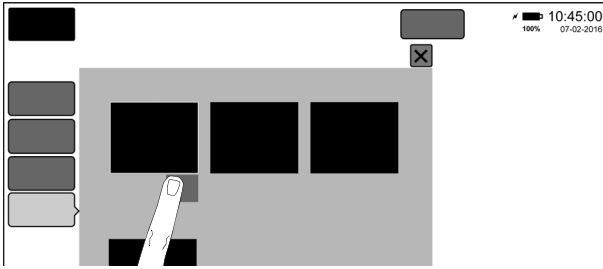

Turn ON the SpO₂ waveform.



This will add a fourth Pleth/SIQ waveform to the bottom of the waveforms in a ventilation mode.

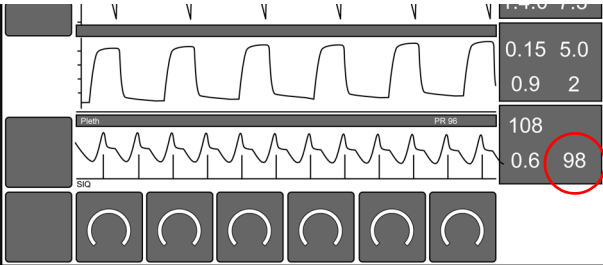

18.7.0.1 SpO₂ and etCO₂ dual waveform display

If the SpO₂ and etCO₂ sensors are connected at the same time and both the waveforms have been selected for display, the bottom waveform will be divided in two. The left area for SpO₂ and the right area for etCO₂.

18.8 SpO₂ Waveform display option

From the Layout panel select SpO₂.

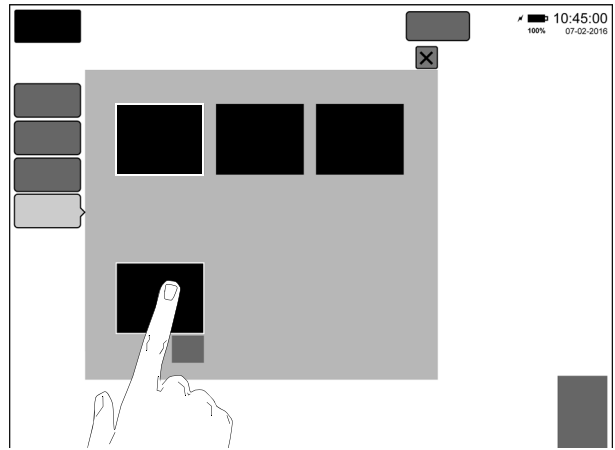

The user can directly confirm the selection without editing the SpO₂ waveform preferences.



If the user presses "Edit" button the "SpO₂ Screen" panel becomes active.

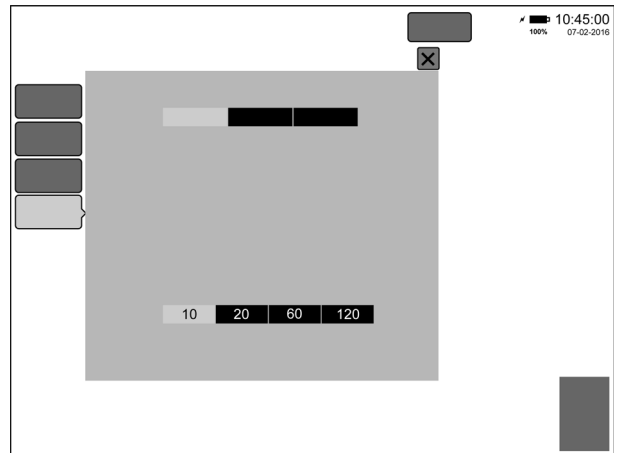

The "SpO₂ Screen" panel allows the user to select which ventilator waveform is displayed at the top of the screen and the time base for the trends.

The default waveforms and trends are:

- Waveform ... Pressure*
- Waveform ... Pleth
- Trend SpO₂
- Trend Set O₂

*The user can choose to display Pressure, Flow or Volume.

Pressing the confirm button will activate the SpO₂ layout.

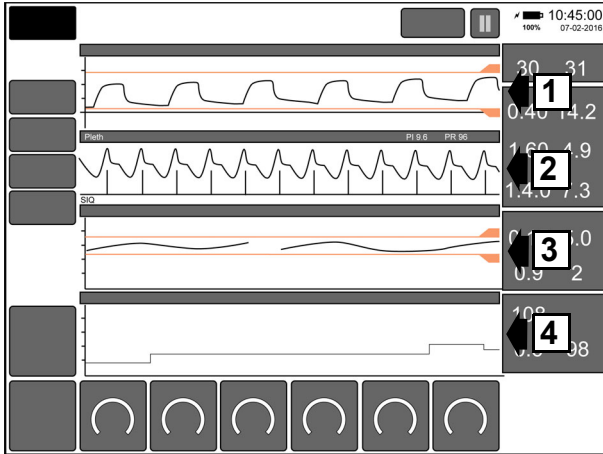

1. Standard Pressure/Flow/Volume waveform.

Shows the one of the user selected waveforms. Pressure waveform being the default.

2. Pleth/SIQ waveform

Shows the Pleth waveform (Upper trace) and the signal quality indicator (SIQ) (Lower trace).

3. SpO₂ trend.

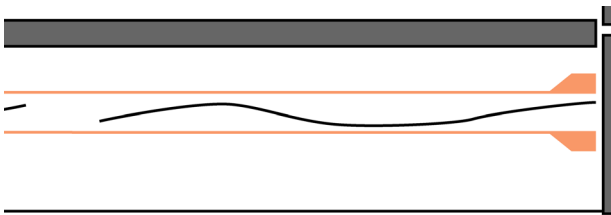

Shows the SpO₂ trend. The SpO₂ trend has two alarm thresholds. The SpO₂ trend alarms thresholds can be manually adjusted via the alarm panel, the defaults are upper 98% and lower 88%. The limits can be set to other values through user preference, see section '43.1.3 Alarms tab' on page 267.

Note: Gaps can appear in the SpO₂ trend due to loss of signal.

4. Set O₂% trend.

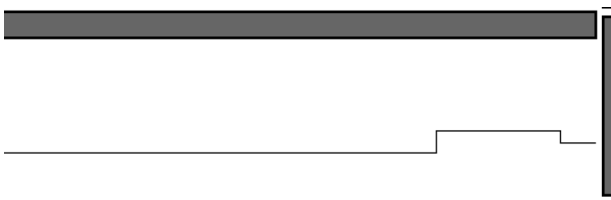

Shows the Set O₂%

18.8.1 SpO₂ Waveform in O₂ therapy

With SpO₂ monitoring turned on the user can select either the three waveforms from the "SpO₂" panel Pleth, SpO₂ and Set O₂ or two larger waveforms Pleth and O₂ by selecting the "Trends" panel.

18.9 SpO₂ module testing

To test the functionality of the SpO₂ module please follow the instructions in section '41.1 Masimo SET[®]' on page 256.

18.10 Operation during mains power interruption (Mains power fail)

The SpO₂ operation and monitoring is not affected when ventilator mains power is interrupted.

18.11 EtCO₂ monitoring (MicroPod™)

18.11.1 Principle of Operation

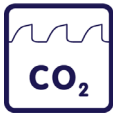

The capnography module is intended to provide professionally trained health care providers with continuous, non-invasive measurement and monitoring of carbon dioxide concentration of the expired and inspired breath and respiration rate. It is intended for use with neonatal, pediatric, and adult patients in hospitals, hospital-type facilities.

18.11.2 Connection to ventilator

Insert the Medi snap connector of the MicroPod™ Cable into the etCO₂/CO₂ socket on the rear of the ventilator.

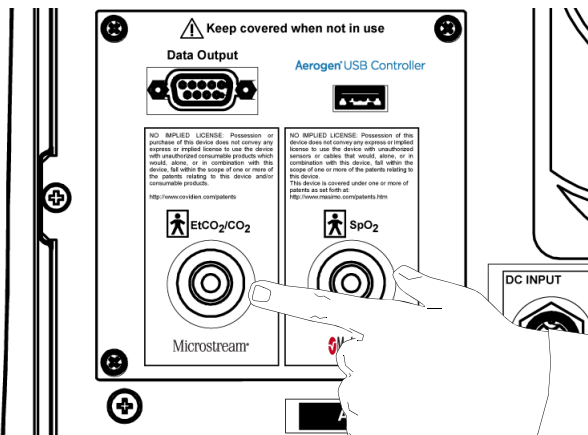

This cable serves for both data communication and power supply, with the module receiving power from the monitor through this connection. A separate power source is not required.

A LED on the MicroPod™ will indicate functioning, as follows:

- During startup the LED will blink slowly
- During normal operation the LED will remain on continuously
- During a communication failure, malfunction, or disconnection of the MicroPod™, the LED will be off.

18.11.3 Initialization Time

The time before CO₂ measurements are available from the MicroPod™ to the ventilator includes power-up time and initialization time. The initialization time includes module initialization and self tests.

Power-up time: Maximum 10 sec

Initialization time: Typically 30 seconds, maximum 180 seconds.

18.11.4 Disconnection

The sensor module can be disconnected at anytime. The monitoring function can be turned OFF before or after disconnection in the Sensor panel or the user can press “Continue without etCO₂” button in the alarm message bar.

Note: When disconnecting a sampling line from the device, hold the CO₂ input connector door open while removing the sampling line, to avoid catching the sampling line on the connector door.

18.11.5 Mounting of module



Note: The MicroPod™ should be mounted with the CO₂ connector facing upwards or to the side to avoid ingress of water into the exhaust port when the MicroPod™ is not in operation.

18.11.6 Connection of a FilterLine™

Once configuration is complete, a patient can be connected to the MicroPod™ for CO₂ monitoring, as follows:

1. Slide open the CO₂ input connector shutter and connect the appropriate sampling line. Screw the sampling line connector into the monitor clockwise until it can no longer be turned.

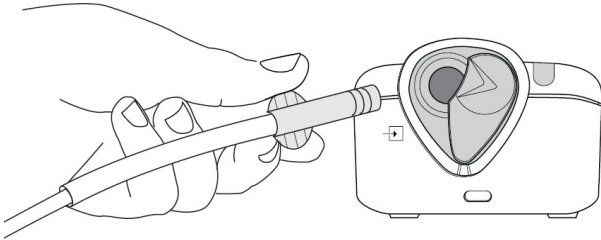

2. Connect the sampling line connector to the patient circuit as shown below. When the sampling line is connected, the MicroPod™ will immediately begin to search for breaths, but it will not indicate a No Breath condition before any valid breaths have occurred.

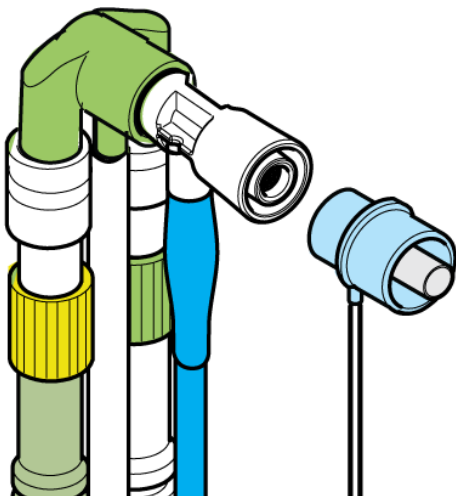

3. CO₂ data will now be provided to the host monitor for display. The host monitor may also display IPI data, if configured to do so.
4. All MicroPod™ messages and alarms are controlled and displayed on the host monitor.

18.12 Configuration

Select the utilities panel, this will now show the sensor tab then select the etCO₂ button.

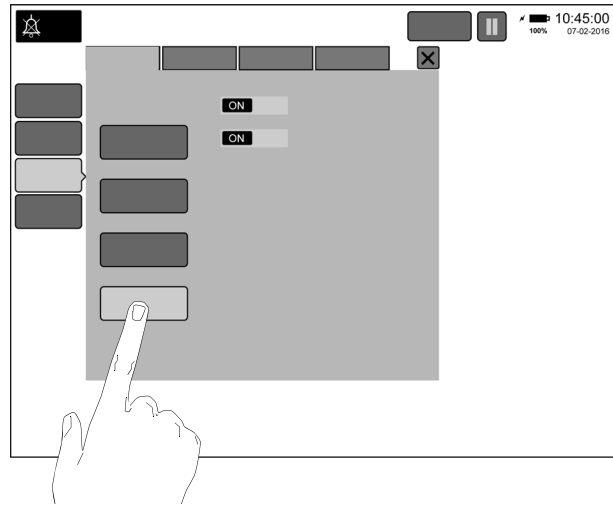

18.12.1 EtCO₂ Monitoring

This button will turn the etCO₂ monitoring function ON or OFF.

Note: This does not turn OFF the sensor. When OFF the displayed etCO₂ value, trend and associated alarms are disabled.

18.12.2 Pump control

This will turn the MicroPod™ pump ON or OFF.

18.12.3 Breath absence alarm time

This will set the time trigger for the "No etCO₂ Breath" Alarm. The range is from 10-60 seconds. The default is 20 seconds

18.12.4 Device information

The panel also displays device information.

- Software version of the MicroPod™.
- Hardware version of the MicroPod™.
- Device serial number.
- Last Calibration date..
- Next Calibration due date.
- Next service due..

Note: See SLE6000 Service manual for service information and calibration instructions.

18.13 Waveforms

From the Layout panel select Waveforms.

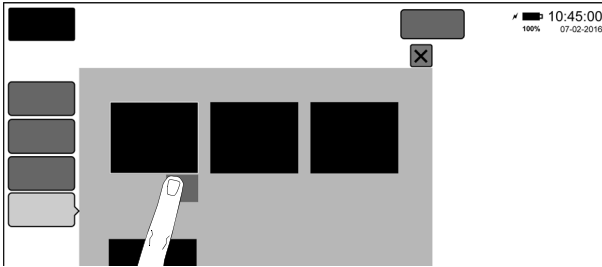

Turn ON the etCO₂ waveform.

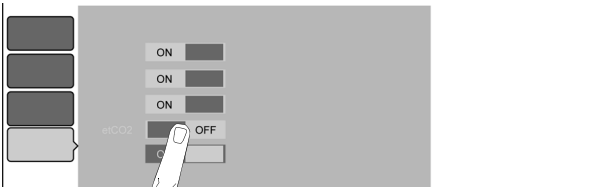

Press the confirm button.

This will add a fourth etCO₂ waveform to the bottom of the waveforms in a ventilation mode.

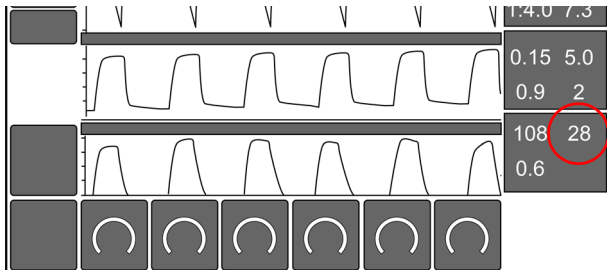

18.13.0.1 EtCO₂ and SpO₂ dual waveform display

If the etCO₂ and SpO₂ sensors are connected at the same time and both the waveforms have been selected for display, the bottom waveform will be divided in two. The left area for SpO₂ and the right area for etCO₂.

18.14 Monitored values

etCO₂ in the selected units will be displayed in the bottom section of the monitored values panel. Circled in the above illustration.

18.15 EtCO₂ alarms thresholds

When etCO₂ monitoring is turned on the following alarm threshold becomes active in the Alarm Limits become active.

etCO₂

18.16 Flow measurement compensation when using side stream etCO₂ monitoring.

The patient flow sensor will compensate for the side stream sample flow by adjusting patient flow measurements when the etCO₂ monitor pump is on and etCO₂ is detected. If the monitor pump is off or etCO₂ is not detected then no flow measurement compensation is made.

18.17 EtCO₂ module testing

To test the functionality of the etCO₂ module please follow the instructions in section '41.2 MicroPod™' on page 257.

18.18 EtCO₂ module Calibration

A calibration should be performed after the initial 1,200 hours of use or 12 months (whichever is sooner), and following that a calibration once a year or every 4,000 operating hours, whichever comes first.

Note: The module will count the hours whilst connected to the ventilator irrespective of being in use or not. (Whilst connected the module is electrically powered). To ensure that premature triggering of the calibration message does not happen, disconnect the module when not in use.

18.19 Operational notes related to etCO₂ monitoring using MicroPod™

Note: During nebulization or suction for intubated patients, in order to avoid moisture buildup and sampling line occlusion, remove the sampling line luer connector from the module.

Note: Replace the sampling line according to hospital protocol or when a blockage is indicated by the host monitor screen. Excessive patient secretions or a build-up of liquids in the airway tubing may occlude the sampling line, requiring more frequent replacement.

Note: When connecting a sampling line to the module, screw the sampling line connector clockwise into the module CO₂ port until it can no longer be turned, to ensure that it is connected securely to the module. This will assure that there is no leak of gases during measurement at the connection point and that measurement accuracy is not compromised.

Note: When the “Replace etCO₂ filterline” message appears on the screen, indicating that the FilterLine™ which is attached to the module is blocked, the module’s CO₂ pump will stop pumping the patient’s breath into the module for testing. Follow the instructions that appear in the Troubleshooting section of this manual: First disconnect and reconnect the FilterLine™. If the message still appears, disconnect and replace the FilterLine™. Once a working FilterLine™ is attached to the module, the pump will automatically resume operation.

Note: Following connection of the CO₂ sampling line to the monitor and to the patient, check that CO₂ values appear on the host monitor display.

Note: Sampling lines with H in their names include a moisture reduction component (Nafion® or its equivalent) for use in higher humidity environments where long duration use of CO₂ sampling is required.

Note: All Biocompatibility Reports for the sampling lines are kept in Oridion (Covidien Jerusalem) AGILE PLM system, doc # DR0025, and will be available upon request.

18.20 Operation during mains power interruption (Mains power fail)

The etCO₂ operation and monitoring is not affected when ventilator mains power is interrupted.

18.21 Cleaning the MicroPod™ Enclosure

The following list of materials had been tested and approved to be used for cleaning the MicroPod™ enclosure: water and soaps, dilution of ammonia <3%, ethanol 70%, isopropanol 70%, and Incidur spray. The cleaning should be performed by wiping the MicroPod™ with a cloth moistened with any of these materials.

This page is intentionally left blank.

OxyGenie®



19. OxyGenie®

Warning: Use of OxyGenie® is contraindicated on patients whose target SpO₂ is outside the following target ranges. 90-94%, 91-95%, 92-96%, 94-98%.

Caution: Before initiating (or re initiating) OxyGenie, check (and adjust if necessary) that the O₂ setting is appropriate for the patients current clinical condition. This initial O₂ setting optimises the initial response and initial response time of the algorithm.

19.1 Introduction

The OxyGenie® system is intended to control the inspired oxygen delivery, to keep the SpO₂ of the patient within a predefined range of SpO₂, during mechanical ventilation, nCPAP, Non Invasive Respiratory support and High Flow Oxygen Therapy administered to Neonatal, Infant and Paediatric patients.

The OxyGenie® algorithm is a closed loop proportional-integral-derivative (PID) controller. Once a second this algorithm uses the patient's SpO₂ (measured using Masimo SET sensors) to calculate the appropriate O₂ setting to maintain SpO₂ within the target range.

OxyGenie® calculates the average amount of oxygen required to keep the patient within the target range. This is calculated using 1 hours data and this value is called the "Reference O₂".

Note: the "Reference O₂" value is an average of the patient's oxygen requirement for the last hour.

The OxyGenie® will not set the O₂ to more than 40% above or below the reference O₂, to avoid large fluctuations in delivered oxygen. The reference O₂ value used for the above function is

capped at 60% so that the OxyGenie® can always reduce the O₂ to 21% when required.

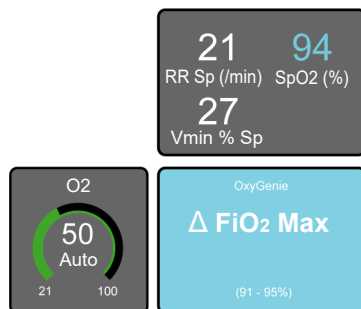

SpO₂ monitoring is obtained via Masimo SET sensors. High and low SpO₂ alarms are automatically set to 1% above the upper end of the target range and 1% below the lower end of the target range. These limits are user adjustable. See SLE uSpO₂ Pulse Oximetry Cable (Masimo SET) IFU for details of conditions which may affect the accuracy of SpO₂ readings.

Caution: Additional ventilator independent patient monitoring (bedside vital monitoring blood gas analyser) should be performed.

Warning: Do not use OxyGenie® if the difference between SpO₂ and SaO₂ is greater than 5%.

OxyGenie® can be used in any mode of ventilation.

19.1.1 OxyGenie® modes of operation

19.1.1.1 Auto mode

OxyGenie® calculates the patients oxygen requirement from the current and previous SpO₂ values every second and adjusts the oxygen blender setting accordingly.

When OxyGenie® is in "Auto" mode the status indication box and the O₂ Control shows "Auto".

When OxyGenie® is active the O₂ control button shows the instantaneous O₂ value being sent to the blender. The monitored O₂ will show the O₂ measured by the oxygen cell. A slight difference in these values is normal

19.1.1.2 Fallback mode:

OxyGenie® will go into "fallback mode" when no valid SpO₂ signal is received. This can occur if the SpO₂ sensor gets detached from the patient or does not make good contact with the skin, or if a low SIQ is reported by the Masimo system.

When OxyGenie® is in "Fallback" mode the status indication box show "waiting for signal" and the "O₂" Control shows " --- "

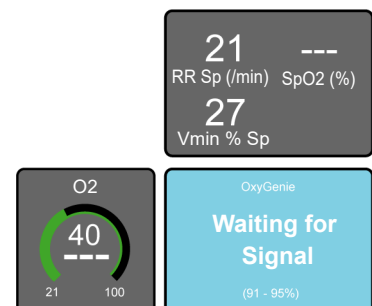

19.1.1.3 Manual override

At any time when OxyGenie® is switched on the user can make manual adjustments to the set O₂, the manually set O₂ will be delivered for 30 seconds

When OxyGenie® is in “manual override” mode the status indication box show “manual override” and the “O₂” Control shows “- - -”

19.1.1.4 Inactive mode

When OxyGenie® is not active the status indication box will not be visible.

19.2 OxyGenie® Fall back mode

Operation of the Fall back mode is as follows.

First 60 seconds of no valid SpO₂ signal:

OxyGenie® will deliver the last O₂ setting.

After 60 seconds of no valid SpO₂ signal

If the last valid SpO₂ reading was within the target range the OxyGenie® will continue to deliver the last set O₂ value.

If the last valid SpO₂ reading was above the target range OxyGenie® will slowly decrease the delivered oxygen towards the reference O₂ value.

If the last valid SpO₂ reading was below the target range OxyGenie® will slowly increase the delivered oxygen towards the reference O₂ value

After SpO₂ signal has been restored

As soon as a valid SpO₂ signal is received OxyGenie® will calculate and set the oxygen requirement based on that SpO₂ value.

During “Fallback mode” the “O₂” control button will show “---” in place of “Auto” and the OxyGenie® status indication will show “waiting for signal”

SpO₂ alarms and exception messages will show in the alarms bar.

19.2.1 Checking the OxyGenie® response

The response of the OxyGenie® to changes in SpO₂ can be seen in the set O₂ shown in the O₂ control button and also in the O₂ trend.

19.2.2 Activating OxyGenie®

Note: OxyGenie® is only available when the SpO₂ sensor is connected and SpO₂ monitoring is turned on.

To activate OxyGenie® press and hold the “O₂” parameter control for 3 seconds.

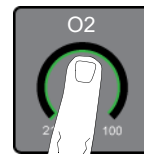

Press the OxyGenie® button.

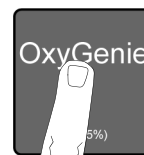

By pressing the confirm button OxyGenie® will become active.



This is indicated by the status indication message box next to the O₂ parameter control.

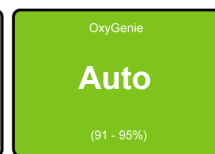

The concentration of O₂ will now be automatically controlled to maintain the target SpO₂ range.

19.2.3 Deactivating OxyGenie®

To deactivate OxyGenie® press and hold the O₂ parameter control for 3 seconds.

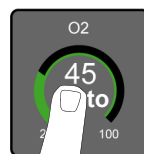

Then press the OxyGenie® button.

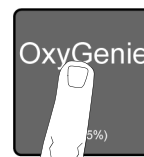

By pressing the confirm button OxyGenie® will become inactive.



The O₂ parameter control returns to normal.



19.2.4 Activating manual override

Caution: Manual override cannot be cancelled once initiated.

To modify the O₂ concentration manually just touch the "O₂" control.

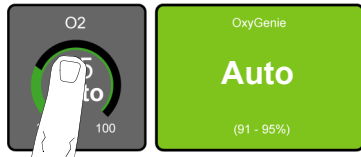

The message box will be replaced by the plus/minus buttons. The text "Auto" will be replaced by three dashes.

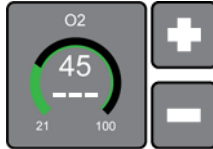

Adjust the O₂% to the required percentage.

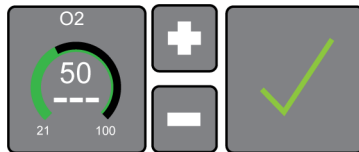

On pressing the confirm button the 30 second manual override will start. This is indicated by message box turning blue and displaying the text "Manual Override" with the remaining seconds being displayed underneath.

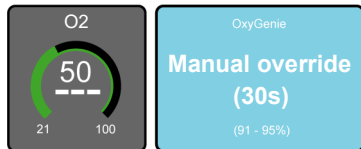

19.2.5 Changing the SpO₂ target range

The SpO₂ target range can be changed by the user at any time. To change the target range, the user must navigate "Utlillites">"Sensors" then select the "SpO₂" button. The available SpO₂ target ranges can be selected from the relevant drop list. On pressing confirm the target range will change to that selected.

19.2.6 Averaging Time

The averaging time is fixed to 2-4 seconds when OxyGenie® is on.

19.3 SpO₂ Waveform display option and OxyGenie®

Pressing the confirm button will activate the SpO₂ layout.

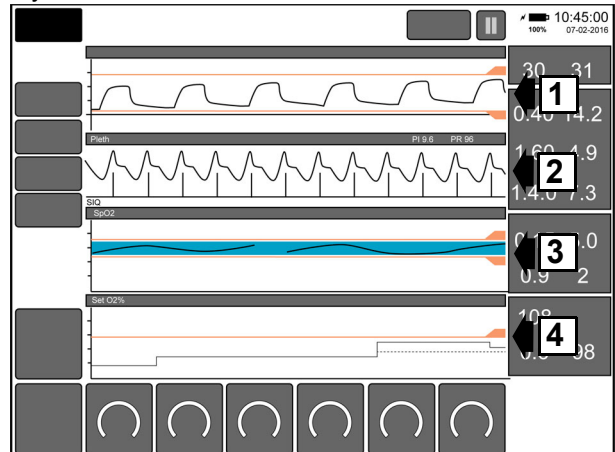

1. Standard Pressure/Flow/Volume waveform.

Shows the one of the user selected waveforms. Pressure waveform being the default.

2. Pleth/SIQ waveform

Shows the Pleth waveform (Upper trace) and the signal quality indicator (SIQ) (Lower trace).

3. SpO₂ trend.

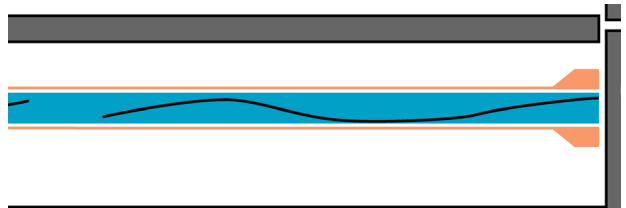

Shows the SpO₂ trend and the SpO₂ target range indicated by the blue bar. The target range is flanked by the two alarm thresholds which are automatically set to $\pm 1\%$ either side of the selected target range. The SpO₂ trend alarms thresholds can be manually adjusted via the alarm panel.

Note: Gaps can appear in the SpO₂ trend due to loss of signal.

4. Set O₂% trend.

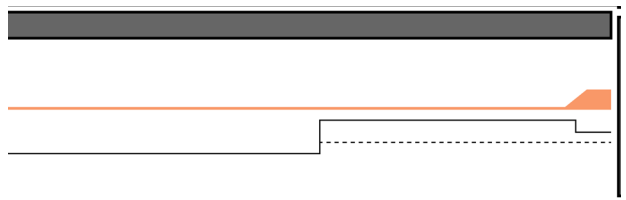

Shows the Set O₂% and the reference O₂% indicated by the dashed line. Also active is the High O₂% alarm threshold.

19.4 OxyGenie® and O₂ Boost

Note. O2 Boost is disabled when OxyGenie® is on.

To use O2 boost first disable OxyGenie®. For more information on O2 boost See “O2 Boost” on page 119.

19.5 OxyGenie® and O₂ Suction

Note. O2 Suction is disabled when OxyGenie® is on.

To use O2 Suction first disable OxyGenie®. For more information on O2 Suction See “O2 Suction” on page 118.

This page is intentionally left blank.

Operational features



20. Operational features

20.1 General

20.1.1 Standby Mode

Warning: Do not enter the “Standby” mode when connected to a patient. No ventilation is delivered.

20.1.2 Apnoea alarm set to “Off”

In any mode where the user can set the Apnoea alarm to “Off” the backup breaths are disabled even when turned “On” unless apnoea is reinstated.

Warning: The user must use an alternative method of detecting an apnoeic episode, whether ventilating invasively or non invasively with the Apnoea alarm turned “OFF”.

20.1.3 Reserve power source

The ventilator will typically run for over 3 hours from 100% battery charge to complete discharge, both in conventional and HFOV modes. Actual battery discharge duration will depend on battery condition and ventilation settings applied. Please refer to the warning for actual safe operation times.

The operation of the ventilator does not change when on the reserve power source.

The operation of the ventilator does not change when charging the reserve power source.

The ventilator does not have to be turned on to charge the batteries. During use the ventilator will keep the batteries fully charged.

In the event of a mains power failure a “Main Power Fail” alarm will sound and be displayed in the alarm panel. The alarm is low priority.

The user can suspend the “Main Power Fail” alarm by pressing the Reset button when the “Main Power Fail” alarm is present.

Warning: In a “Mains Power Fail” condition and if the user clears the “Mains Power Fail” alarm, the next power related alarm that will trigger will be the medium priority “Battery Low” alarm. This indicates that the internal power source has reached 25% capacity. The user shall remove the patient to an alternative form of ventilation at this point if mains power cannot be restored. If the user clears the medium priority “Mains Power Fail” alarm, the next power related alarm that will trigger will be the high priority “Battery Low” alarm. This indicates that the internal power source has a less than 10 minutes remaining battery life.

On cancelling the medium Priority “Battery Low” alarm the following new icon will appear above the battery icon.



This indicates that the medium priority “Battery Low” alarm is inhibited.

The battery charge % status will continue to display the percentage below the new icon until the high priority “Battery Low” alarm is triggered indicating 10 minutes of battery life remaining.

The triggering of the high priority “Battery Low” alarm removes the “Low Battery alarm inhibit icon”.

Once all battery power has been exhausted the complete power fail alarm will sound and the ventilator will cease to operate.

Warning. The ventilator can be used with a completely discharged battery, but a note must be taken that in the event of a mains power failure the ventilator will cease to ventilate the patient.

Warning. Do not allow the batteries to remain in a deep discharged state. Recharge the batteries as soon as possible to preserve battery life. If the ventilator is to be placed in storage then ensure the batteries are fully charged.

20.1.4 Parameter Memory

The user should be aware that the ventilator will remember user parameter settings when switching between modes. Though when the setting is remembered between ventilatory modes the parameter title may change. An example is the CPAP parameter in CPAP mode becomes the PEEP parameter in CMV mode.

20.1.5 HFO variable I:E ratio (Only available with HFOV and nHFOV options)

The variable I:E ratio allows the user to increase the expiratory phase in proportion to the inspiratory phase by the indicated ratio 1:2 or 1:3.

Warning: Inappropriate changes in the I:E ratio may result in a reduction of the volume for each HFO cycle and the subsequent minute volume delivered to the patient. Secondary monitoring of TcPO₂ may be required.

20.1.6 Pressure Support Breaths Not Delivered as Set

There are a number of scenarios where the ventilator may have difficulty in achieving the set pressure on support breaths.

Scenario 1

If the set support level is 5mbar or less above the PEEP with a short Ti time.

Scenario 2

If the patient lung is large or a large bore circuit is used. If the patient lung/circuit has a large compliance then it could have a large time constant so regardless of what pressure the ventilator puts out, it could take longer than the delivered Ti to rise to that pressure.

20.1.7 Trigger sensitivity

With a flow sensor fitted.

The breath trigger sensitivity needs to be set in all patient interactive modes (default 0.6 ml). Setting the breath trigger sensitivity at its most sensitive level (0.2ml) may allow the ventilator to interpret background noise in the patient circuit as patient breathing, resulting in auto-triggering. When the ventilator is used with a flow sensor the ventilator monitors gas flow to detect the patient breath.

When the ventilator is used without a flow sensor the ventilator monitors pressure change to detect the patient breath.

Without a flow sensor fitted.

The breath trigger sensitivity needs to be set in all patient interactive modes. Default 50%. Setting the breath trigger sensitivity at its most sensitive level (100%) may allow the ventilator to interpret background noise in the patient circuit as patient breathing, resulting in auto-triggering. When the ventilator is used with a flow sensor the ventilator monitors gas flow to detect the patient breath.

When the ventilator is used without a flow sensor the ventilator monitors pressure change to detect the patient breath.

20.1.8 Volume Targeted Ventilation, Vte (VTV)

20.1.8.1 Ti

When VTV is set to ON in CPAP, CMV, PTV, PSV and SIMV, if the inspiratory volume exceeds a safety limit, the breath is terminated, to prevent over-distension of the lung. This will result in a lower measured Ti than set. The actual inspiratory time is displayed in the lung mechanics and measurement panel as Ti meas.

20.1.8.2 Vte Target Resolution

The tidal volume parameter control has three different resolutions.

From 2ml to 10ml the parameter increments in 0.2ml steps (Fine resolution).

From 10ml to 100ml the parameter increments in 1ml steps (Standard resolution).

From 100ml to 300ml the parameter increments in 5ml steps (Coarse resolution).

20.1.9 Max Ti in PSV

In PSV mode the Ti parameter is marked Max Ti because the termination sensitivity control (stop support at %) can terminate the breath before the set inspiratory time is reached.

20.1.10 Suctioning (Closed suction).

Closed suction catheters can be used in all invasive modes. No special setting is required for the use of a closed suction catheter.

20.1.11 VTV & HFOV

Volume control is to be achieved by automatic adjustment of the delta P, in a similar way to PIP being automatically controlled in conventional modes to maintain a fixed expiratory volume. There are significant differences (between HFOV + VTV and conventional VTV) as the volume is updating much faster than it does in conventional breath mode.

In conventional breath modes with VTV, a decision to adjust the pressure is made whenever the expiratory volume is received from the monitor. This is typically once per standard breath. In HFOV expiratory volumes are updated once per cycle. The expiratory volumes are subject to large variations on a cycle by cycle basis and are received up to 20 times a second. Rather than make an adjustment on every cycle, they will be made on the average expiratory volume.

As with conventional ventilation the Delta P "ΔP" control message will become the "ΔP Max".

20.1.11.1 Vte Target Resolution

The tidal volume parameter control has two different resolutions.

From 2ml to 10ml the parameter increments in 0.2ml steps (Fine resolution).

From 10ml to 50ml the parameter increments in 1ml steps (Standard resolution).

20.2 Types of leak compensation

20.2.1 VTV and patient leak

The ventilator will attempt to achieve the set VTV within the following limiters of Max PIP or 50% leak, or

The ventilator will increase the Max PIP to achieve the target volume and automatically compensate for a leak of up to 50%.

20.2.2 NIV modes and patient leak

The ventilator will increase the flow of the fresh gas in response to patient leak to a maximum of 15 l/min to maintain the CPAP/PEEP pressure set by the user.

20.2.3 PSV mode automatic leak Compensation

If a large leak is present in the respiratory circuit, it may prevent the flow from being terminated in PSV mode. If the leak flow is above the selected termination sensitivity level the flow would not terminate as the flow would never reach the termination level. An algorithm has been added that will compensate for the leak and enables the termination levels below leak flow to be terminated at the leak flow level. If the termination level is above the leak flow, the flow is terminated at the selected termination level. An algorithm would compensate for leak flows up to 5 l/min or 50% of the peak flow whichever happens first. It is also only active if the leak volume is between 10% to 50%.

20.3 O₂ Suction

Note: O₂ suction is only available if activated in user preferences. See “User preferences” on page 266.

Caution. O₂ Suction is disabled when Auto O₂ is on. See “OxyGenie® and O₂ Suction” on page 113.

The O₂ suction feature allows the user to increase the delivered % of oxygen prior to, during and after a suctioning procedure for a fixed time.

To activate O₂ Suction press and hold the O₂ parameter control for 3 seconds and then press the confirm button.

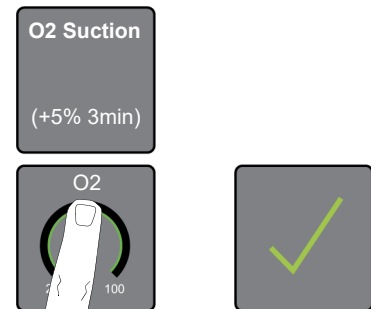

“O₂ Suction in Standby” message is displayed above the O₂ parameter control (the control is renamed “O₂ Suction”). The plus/minus and confirm button also become active.

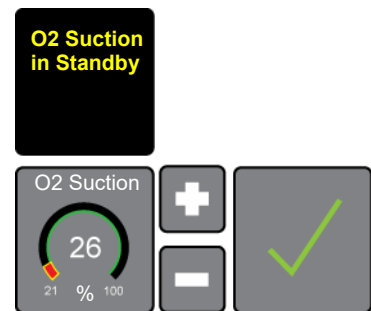

The user if required can adjust the percentage increase over the set at his point.

The colour of the ‘eyebrow’ bar of the % O₂ parameter control remains the same for the part that represents the original % O₂ setting, but the colour changes to red for the part that represents the O₂ increase. The example shows a set percentage of 30% with a default boost of 5%.

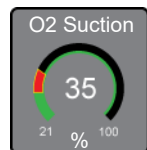

Note: The default increase in O₂ can be pre set between 1 to 10% above the current setting or 100%. The factory default is 5%. See “User preferences” on page 266.

The user can increase or decrease the % O₂, but it cannot be reduced below the original set value.

The user presses confirm button. This action starts the O2 Suction procedure.

A message “O2 Pre Suction in Progress” message is displayed above the “O2 Suction” parameter control for a countdown of 3 minutes. The ventilator waits for a disconnection in the following 3 minutes.

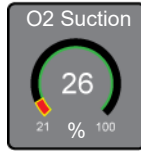
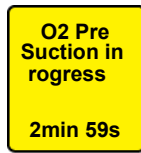

If the user doesn't disconnect the patient during the 3 minute window the boost will automatically finish.

When the user disconnects the patient. The ventilator will display a message “O2 Suction in Progress” and will start counting down for 2 minutes.

The alarm mute is automatically instated. During this time the ventilator waits for a re-connection. If the User doesn't reconnect the patient before the time is up, this will cause the ventilator to alarm. The procedure stops at that point.

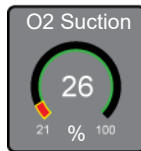
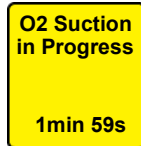

When the user reconnects the patient before the end of the 2 minute window for suctioning, the ventilator starts a new 2 minute countdown, at the elevated % O2. A message states “O2 Post Suction in Progress”.

The procedure will stop at the end of the 2 minute countdown.

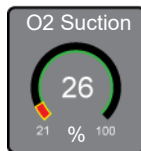

If the user presses and holds the O2 Suction parameter control at any time a new control appears above the message panel. If the user presses this control and confirms the action the procedure is cancelled. The % O2 returns to original value and message clears.

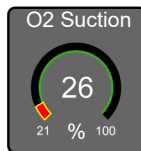
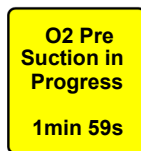
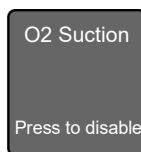

20.4 O2 Boost

Note: O2 Boost is only available if activated in user preferences. See “User preferences” on page 266.

Caution. O2 Boost is disabled when Auto O2 is on. See “OxyGenie® and O2 Boost” on page 113.

The O2 Boost feature allow the user to increase the delivered % of oxygen to a preset or user set increase for a maximum of two minutes.

To activate O2 Boost press and hold the O2 parameter control for 3 seconds and then press the confirm button.

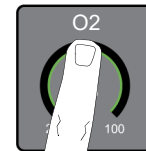
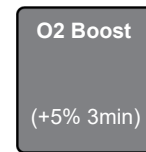

“O2 Boost in Standby” message is displayed above the O2 parameter control (the control is renamed “O2 Boost”).

The plus/minus and confirm button also become active.

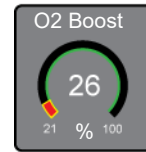

Note: The default increase in O₂ (Boost) can be pre set between 1 to 10% above the current setting or 100%. The factory default is 5%. See “User preferences” on page 266.

The colour of the ‘eyebrow’ bar of the % O2 parameter control remains the same for the part that represents the original % O2 setting, but the colour changes to red for the part that represents the O2 increase. The example show a set percentage of 30% with a default boost of 5%.

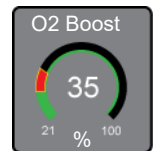

The user can increase or decrease the % O2, but it cannot be reduced below the original set value.

The user presses confirm button. This action starts the O2 boost procedure

A countdown timer is set for 2 minutes. After 2 minutes the procedure stops.

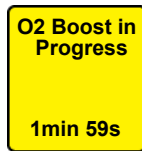

If the user presses and holds the O2 Boost parameter control a new control appears above the message panel. The user presses this control and confirms the action the procedure is cancelled.

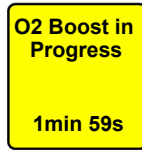
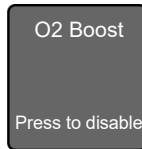

The % O2 returns to original value and message clears.

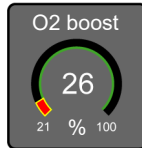

20.5 Alarm thresholds

The ventilator for each mode has sets of pressure related alarm thresholds that are set by the user or auto set by the ventilator around the user set parameters.

The only mode that does not have any pressure related alarm thresholds is O2 therapy.

20.5.1 Alarm thresholds for conventional modes (invasive and non invasive - dual limb).

The diagram below shows the pressure alarm thresholds for conventional modes (invasive and non invasive).

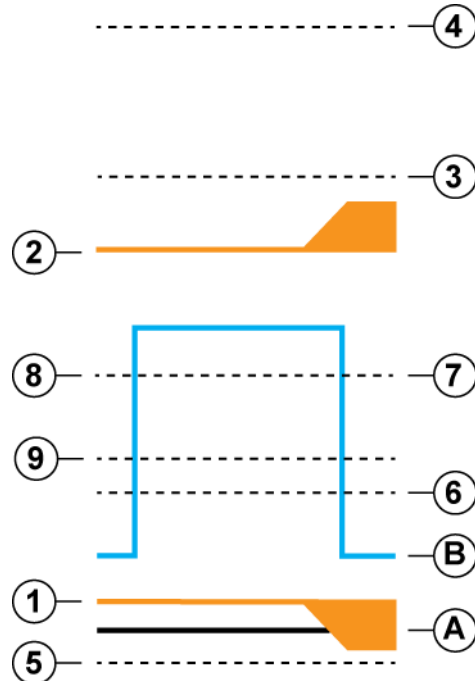

A. Zero pressure line

B. Waveform

Alarm thresholds

1. Low Pressure (Low PEEP alarm control) Autoset and user adjustable.
2. High PIP (High PIP alarm control). Autoset and user adjustable.
3. High pressure threshold exceeded (+5 mbar above PIP). Autoset.
4. High pressure threshold exceeded (+20 mbar above PIP) Autoset.
5. Sub ambient (-2 mbar below zero pressure). Autoset.
6. High PEEP (High PEEP alarm control) Autoset and user adjustable.
7. Low PIP (Low PIP alarm control). Autoset and user adjustable.
8. Fail to cycle. Autoset.
9. Continuing positive pressure. (+5 mbar above CPAP/PEEP for more than 4 seconds). Autoset.

20.5.2 Alarm thresholds for Oscillatory modes (invasive and non invasive - dual limb).

20.5.2.1 HFOV & nHFOV

The diagrams A & B show the pressure alarm thresholds (invasive and non invasive modes).

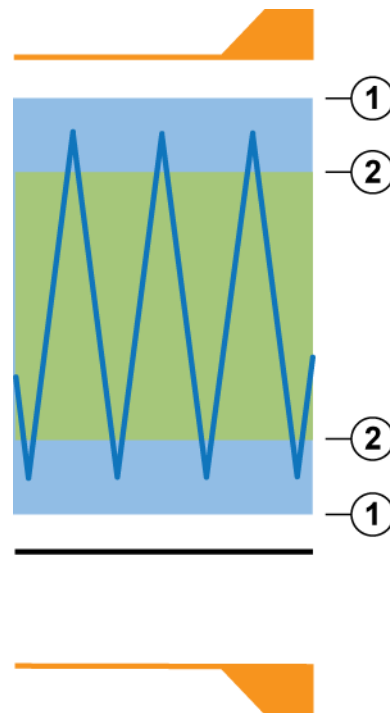
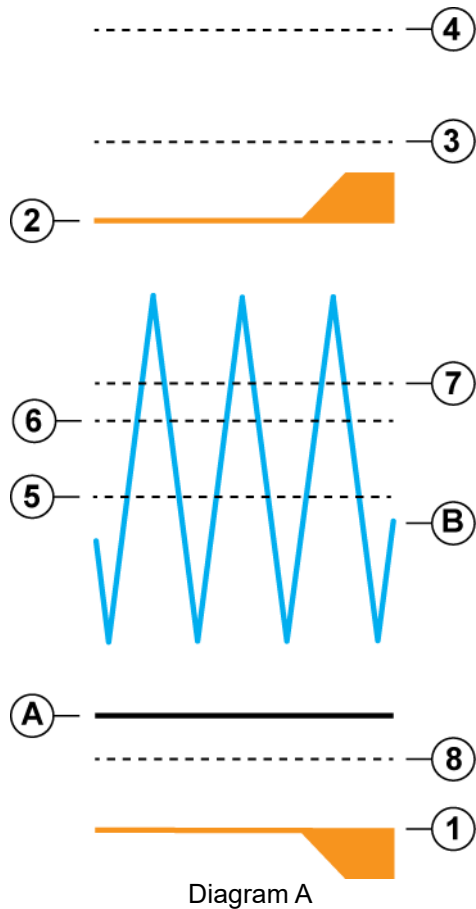

1. Unexpected rise in delta P. (+5 mbar above delta P). Autosest.

2. Unexpected drop in delta P. (-5 mbar below delta P). Autosest.

A. Zero pressure line

B. Waveform

Alarm thresholds

1. Low pressure (Low Paw alarm control) Autosest and user adjustable.
2. High pressure (High Paw alarm control) Autosest and user adjustable.
3. High pressure threshold exceeded (+5 mbar above PIP). Autosest.
4. High pressure threshold exceeded (+20 mbar above PIP) Autosest.
5. Unexpected drop in mean P. (-5 mbar below mean P). Autosest.
6. Unexpected rise in mean P. (+5 mbar above mean P). Autosest.
7. Continuing positive pressure. (+15 mbar above mean P for more than 4 seconds). Autosest.
8. Sub ambient (Mean pressure to go -2 mbar below zero pressure). Autosest.

20.5.2.2 HFOV+CMV (invasive - dual limb)

The diagram below shows the pressure alarm thresholds (invasive mode).

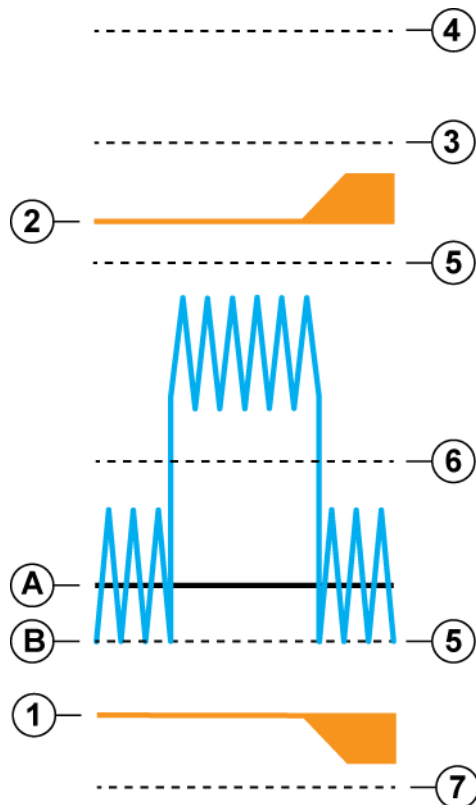

A. Zero pressure line

B. Waveform

Alarm thresholds

1. Low pressure (Low Paw alarm control) Autoset and user adjustable.
2. High pressure (High Paw alarm control) Autoset and user adjustable.
3. High pressure threshold exceeded (+5 mbar above PIP). Autoset.
4. High pressure threshold exceeded (+20 mbar above PIP) Autoset.
5. Pressure change detected. (See "Alarm message: Pressure change detected." on page 204.) Autoset.
6. Continuing positive pressure. (+10 mbar above mean P for more than 4 seconds). Autoset.
7. Sub ambient (Mean pressure to go -2 mbar below zero pressure). Autoset.

20.5.3 Alarm thresholds for conventional modes (non invasive - single limb).

The diagram below shows the pressure alarm thresholds for conventional modes (non invasive).

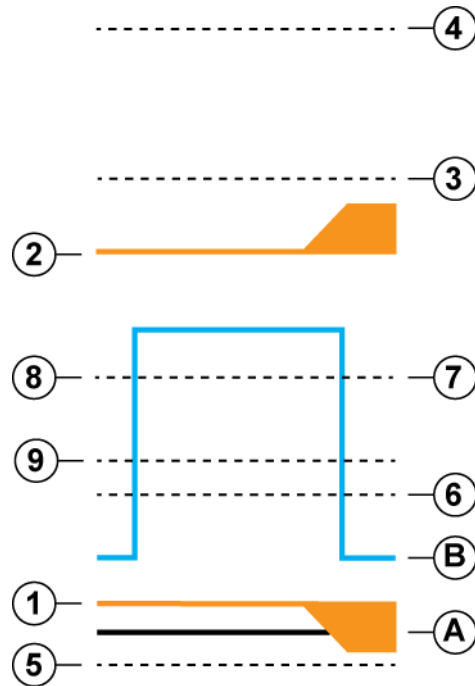

A. Zero pressure line

B. Waveform

Alarm thresholds

1. Low Pressure (Low PEEP alarm control) Autoset and user adjustable.
2. High PIP (High PIP alarm control). Autoset and user adjustable.
3. High pressure threshold exceeded (+5 mbar above PIP). Autoset.
4. High pressure threshold exceeded (+20 mbar above PIP) Autoset.
5. Sub ambient (-2 mbar below zero pressure). Autoset.
6. High PEEP (High PEEP alarm control) Autoset and user adjustable.
7. Low PIP (Low PIP alarm control). Autoset and user adjustable.
8. Fail to cycle. Autoset.
9. Continuing positive pressure. (+5 mbar above CPAP/PEEP for more than 4 seconds). Autoset.

20.5.4 High pressure threshold alarm operation.

If a user set High PIP alarm threshold is crossed by 5 mbar or 20 mbar the ventilator carries out the following actions.

Crossing High PIP threshold by 5 mbar

If the High PIP alarm threshold is exceeded by more than 5mbar the ventilator drops the fresh gas supply for 3 seconds. It maintains the mean pressure and stops ventilating. This is true for all modes of ventilation. The ventilator will re-instate the fresh gas supply after 3 seconds and then restart ventilation a further 5 seconds after re-instatement of the fresh gas. The “High Pressure Threshold Exceeded” alarm will sound until the condition is cleared. If the ventilator encounters the same conditions after restarting ventilation the cycle is repeated.

Crossing the 20mbar ventilator set threshold

If the High PIP alarm threshold is exceeded by more than 20mbar the ventilator drops all the gas supplies for 6 seconds. It does not maintain the mean pressure and stops ventilating. This is true for all modes of ventilation. The ventilator will re-instate the fresh gas supply after 6 seconds and then restart ventilation a further 2 seconds after re-instatement of the fresh gas. The “High Pressure Threshold Exceeded” will sound until the condition is cleared. If the ventilator encounters the same conditions after restarting ventilation the cycle is repeated.

20.5.5 Low pressure threshold alarm operation

Note: The user must be made aware that the Low Alarm threshold will only autotrack down to 1mbar in conventional ventilation. If the user wishes to set the alarm lower than 1mbar then this has to be done manually. If the alarm threshold is manually set lower than 1mbar and a pressure related parameter is adjusted the low alarm threshold will return to 1mbar or to the threshold dictated by the CPAP pressure. The user will have to manually re-adjust the alarm threshold to the required level.

Warning: If the user sets the low alarm threshold below 1mbar the ventilator will not be able to detect a patient circuit disconnection of the following type: Inspiratory limb disconnection from the ET manifold complete with coloured restrictor. (In this case the low alarm will not be triggered as it is set to 0 mbar or less, also the leak alarm will not activate as the restrictor is still on the inspiratory limb.

The ventilator will also not instantly detect an ET tube disconnection from the flow sensor, if the low alarm is set to 0 mbar or less. The ventilator will alarm with a “Breath Not Detected” alarm after 20 seconds.

20.6 Patient Circuits, Humidification and Nitric Oxide Therapy

20.6.1 Invasive ventilation & autofeed humidification chambers

When using the ventilator in invasive ventilation with autofeed humidification chambers the water bag should be mounted higher than the max Delta P or MAX PIP being used.

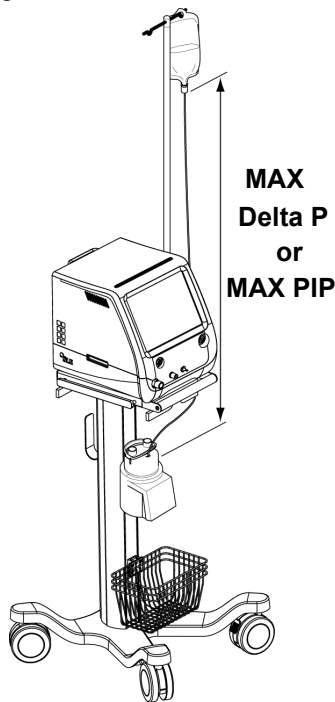

Note: Ensure that the autofeed humidification chamber supply line is primed by forcing water through the supply line into the chamber.

Note: For non-invasive modes mount the bag as high as possible. If the bag inflates due to higher CPAP pressures then release the pressure at regular intervals.

To calculate the approximate height of the water bag use the following conversion:

1 mbar = 1cm, then add 25cm to the calculated high for the final height of the bag.

Mounting the bag lower could allow the ventilator to pressurize the bag and thus prevent the chamber from filling with water. Also, the bag in return pressurizes the chamber which could cause high or sustained pressure alarms to be triggered.

20.6.2 Non-Invasive ventilation & autofeed humidification chambers

When using the ventilator in non-invasive ventilation with autofeed humidification chambers the water bag should be mounted as high as possible. If the bag inflates due to higher CPAP pressures then release the pressure regularly from the bag.

20.6.3 Nitric Oxide Therapy

When the ventilator is used in conjunction with an Inhaled Nitric Oxide Delivery System, the ventilator requires two NO scavenging filters (SLE part N° N4110 connected in parallel with a dual exhaust hose assembly SLE part N° N4110/10) fitted to the exhalation block (remove the silencer). This is supplied as a complete kit under SLE part N° N4110/20. The flow of exhausted gas exceeds the capability of a single scavenging filter.

Dual Exhaust Hose Assembly SLE Part No: N4110/10

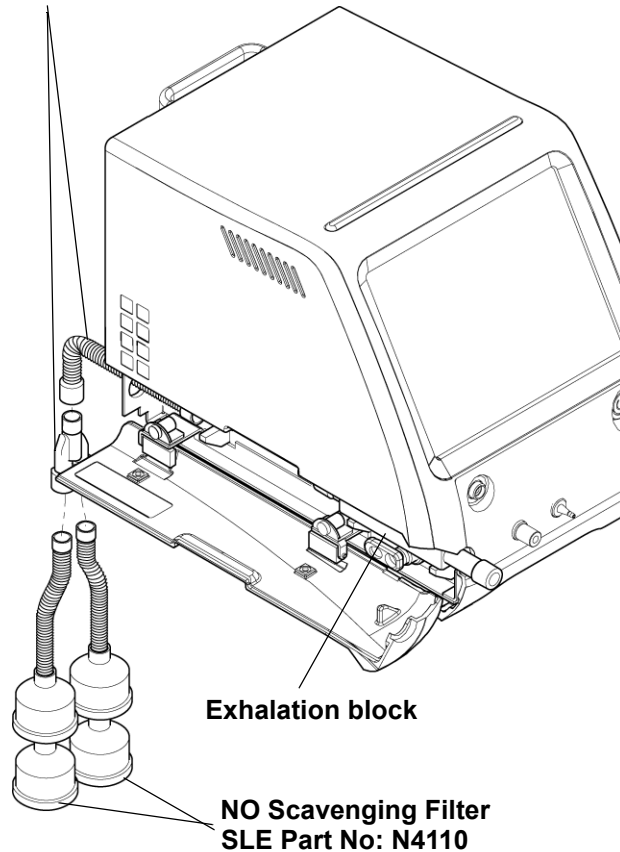

Caution: After using the ventilator with Nitric Oxide therapy, rinse the exhalation block with water before cleaning, disinfection or autoclaving. This is to remove any deposits of NO that could react during steam autoclaving with water to form Nitrous acid or Nitric acid.

Warning: Using the ventilator with only one N4110 scavenging filter, (fitted directly to the exhaust port) will cause a back pressure to be generated. This will cause all the pressure readings to become slightly elevated.

20.6.4 Nebulization of Medication

20.6.4.1 Nebulization using Aerogen®

Caution: Only use Aerogen® USB Controller with the SLE6000.

Warning: Only use ultrasonic nebulisation devices with the SLE6000.
A pneumatically driven nebuliser will cause increased pressure within the inspiratory limb of the circuit, which will trigger the “Blocked Fresh Gas” alarm.

Warning: Do not use the flow sensor when nebulizing medication.

When using the ventilator with a nebuliser, the ventilator should be used as time cycled pressure limited device by removal of the flow sensor.

Removing the flow sensor from the ET manifold whilst still reconnected to the ventilator is not advised as the “Breath Not Detected” alarm will become active and mask other alarm conditions that could arise.

Caution: Read and study all instructions supplied with Aerogen® USB Controller.

- 1 Perform a functional test of the Aerogen® nebuliser prior to use as described in the Aerogen® IFU.
- 2 Connect the Aerogen® Solo or Aerogen® Pro nebuliser by firmly pushing into the T-piece.
- 3 Connect the Aerogen® USB Controller to the nebuliser.
- 4 Insert the nebuliser and the T-piece in the breathing circuit.
- 5 The Aerogen® USB controller for use with Aerogen® Solo is powered from the Aerogen® Controller port situated on the rear of the ventilator.



Note: Aerogen® USB Controller can only be operated from a USB port on any medical electrical equipment approved to IEC/EN 60601-1 or Aerogen USB Controller AC/DC adaptor.

- 6 Open the plug on the nebuliser and use a pre-filled ampoule or syringe to add medication to the nebuliser. Close the plug.

Note: To avoid damage to the Aerogen® Solo, do not use a syringe with a needle.

- 7 To operate in 30 Minute Mode press the On/Off button once.
- 8 To operate in 6 Hour Mode press the On/Off button from the off mode for >3 seconds.
- 9 Verify the correct mode of operation is selected.
- 10 Verify that aerosol is visible.
- 11 When nebulisation is complete remove the Aerogen® Solo and USB controller from the circuit.
- 12 Calibrate and replace the flow sensor if required.

20.7 Using the SLE6000 with SLE500E and SLE500S medical air compressors

Caution: When using the SLE6000 in conjunction with either the SLE500E or SLE500S medical air compressors the user needs to be aware that the HFO performance is limited.

The SLE500E or SLE500S medical air compressors maximum flow is 60 l/min the SLE6000 requires 85 l/min. This disparity will only be evident in HFO mode where Delta P pressures of greater than 150 mbar will cause the MAP (mean airway pressure) to be unstable.

This page is intentionally left blank.

User interface description

“Standby mode” on page 128

“Ventilation mode” on page 140



21. User interface description

This section describes all the features of the user interface. The chapter is divided into two sections, the first Standby mode and the second Ventilation mode. Standby mode describes the function of the user interface whilst in Standby mode and Ventilation mode the differences when in a ventilatory mode.

21.1 Standby mode

Immediately after turning on the ventilator, the first screen presented to the user will be “Standby”.

Warning. In “Standby” mode. The ventilator does not provide any patient support and all patient alarms are inactive. The information panel carries the statement “Standby: Patient not ventilated”.

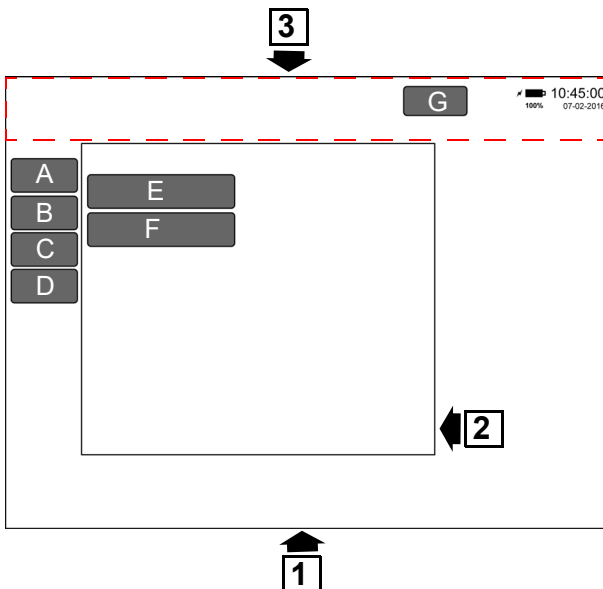

1. User interface
2. Information panel
3. Information bar
- A. Mode button (Control Button)
- B. Alarms button (Control Button)
- C. Utilities button (Control Button)
- D. Layout button (Control Button)
- E. Start/Resume ventilation button
- F. Calibration and utilities button
- G. Multi function button

21.1.1 User interface (1)

The active display is referred to as the user interface. Apart from the ON/OFF buttons all other controls are through the user interface. All the controls are touch controls requiring a single touch to operate.

21.1.2 Information panel (2)

The information panel will display information and all associated ventilatory features.

21.1.3 Information bar (3)

The information bar is an area reserved at the top of the user interface that displays alarm messages, time and date, power indicators. It also contains the 120 second alarm audio pause control and a multi function button.

21.1.4 Generic button/panel functions

21.1.4.1 Panel functions

Pressing the same control button that opened a panel, while the panel is open shall close the panel. Pressing another control button shall close the current panel and open the associated panel of the last pressed button. No changes to the original menu shall take effect.

Pressing the 'X' button at the top right corner of the menu if required, shall close the menu. No changes shall take effect.



21.1.4.2 Parameter time out

If the ventilator is in a ventilation mode and the user doesn't interact with a control for 15 seconds then the control shall be deselected and no changes shall take effect.

21.1.4.3 Panel time out

If the user doesn't interact with a menu for 120s then the window shall automatically close and no changes shall take effect.

21.1.4.4 Button states

All the buttons have two states, Available and Selected. A selected button is White. An available button is dark grey.



21.1.4.5 Mode button (A)

This button selects the mode sub panels, Invasive, Non Invasive and standby.

21.1.4.6 Start/Resume Ventilation button (E)

The mode button allows the user to select a mode of ventilation.

21.1.4.7 Alarms (B)

This button has no function in standby mode. When pressed it will display the alarm sub panel with the factory or user set default values.

21.1.4.8 Utilities button (C)

This button selects the following sub panels:

Sensors (see “Sensors tab (without external sensors)” on page 131)

Brightness (see “Brightness tab” on page 131)

System (see “System Tab” on page 132)

Data (see “Data tab” on page 133)

21.1.4.9 Calibration & Utilities button (F)

This has the same function as the Utilities button (C).

21.1.4.10 Layout button (D)

This button selects the layout sub panel. In standby mode only the trends can be selected. (see "Layout Tab" on page 135)

21.1.4.11 Multi function button (G)

This button has the following functions:

Lock/unlock screen. (See section 21.2.13 on page 144).

Alarm reset and alarm acknowledge. (See section 21.1.6 on page 129)

Note: The multi function button also changes shape when activated for the Continue without flow sensor alarm condition.

21.1.5 Mode button & Start/Resume Ventilation button

Touching either button (A or B) activates the mode selection tabs.

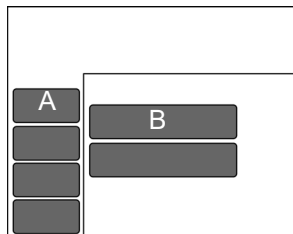

The Mode panel has three available tabs: Invasive, Non-invasive and Standby.

Note: The standby tab is available but nonfunctional in standby mode.

Note: The mode that will be highlighted will depend on whether the ventilator is set to user set preferences, factory defaults or last selected mode.

Select the required mode from area (1) and then press the "Confirm" button (C) to select.

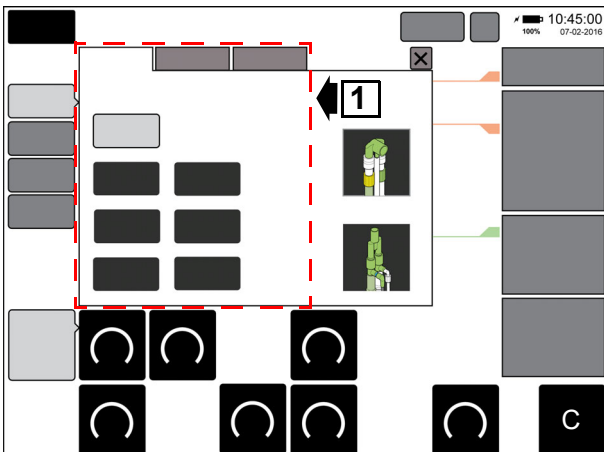

See section 21.2 on page 140 for mode related descriptions.

21.1.6 Alarm button

Touching "Alarm" button (D) activates the Alarm tabs.

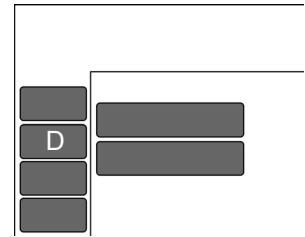

The Alarm panel has three available tabs: Limits (E), History (F) and Loudness (G).

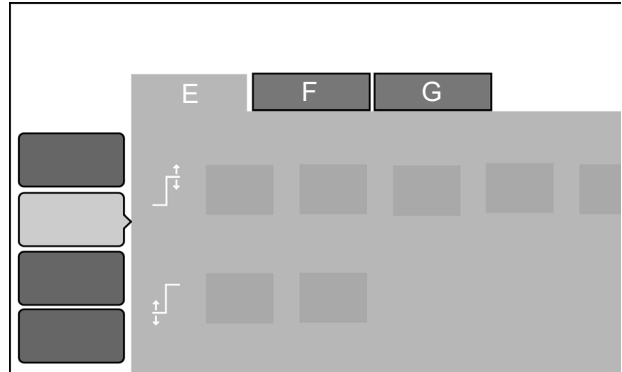

The default tab is the Limits (E)

21.1.6.1 Limits tab

The Limits tab shows all available alarm thresholds.

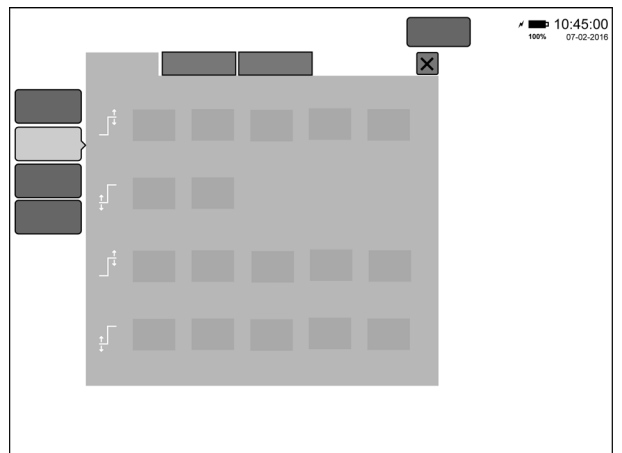

Note: The Limits tab is nonfunctional in standby mode.

21.1.6.2 History tab

The History tab shows the last 1000 alarm events.

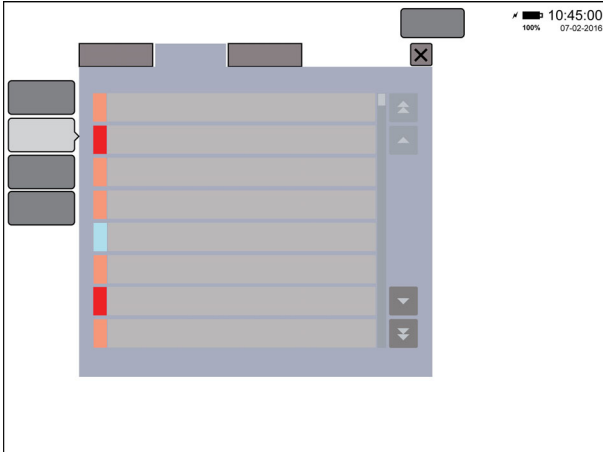

The tab displays the following information for each alarm event.

Priority - Indicated by colour. Red-High, Yellow-Medium, Blue-Low.

Time - hh/mm

Date - DD/MM/YYYY or MM/DD/YYYY

Duration in Hours, Minutes and Seconds

Values - non functional in this release of software.

Limit - the alarm setting

Not Ack - Indicator for user acknowledgment of alarm at time of activation

The alarm history can be viewed by using the scroll arrows at the right hand side of the history. The single arrow is slow scroll the double arrow is fast scroll. When at the beginning or end of the list the user will only be able to select arrows that can scroll through alarm messages.



21.1.6.3 Loudness tab

The Loudness tab allows the user to adjust the alarm sounder volume. The default setting is 60%.

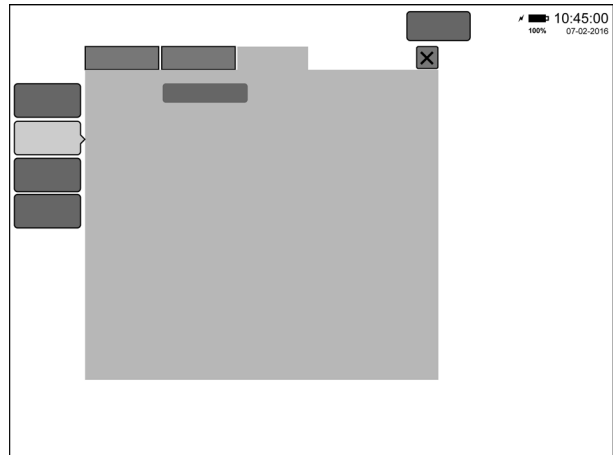

The control is limited to 20% increments.

Minimum setting 20% maximum 100%.

Note: The user setting is reset to 60% on power up.

21.1.7 Utilities & Calibration & Utilities button

Touching "Utilities" button (H) or the "Calibration & Utilities" button (J) activates the Utility tabs.

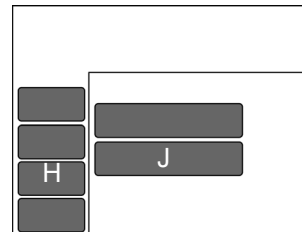

The Utility panel has four available tabs: Sensors (K), Brightness (L), System (M) and Data (N).

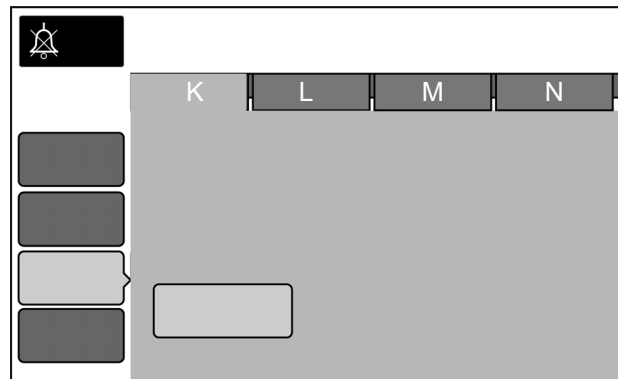

21.1.7.1 Sensors tab (without external sensor/s)

The sensor tab allows the user to calibrate the flow sensor or perform a one point O2 calibration.

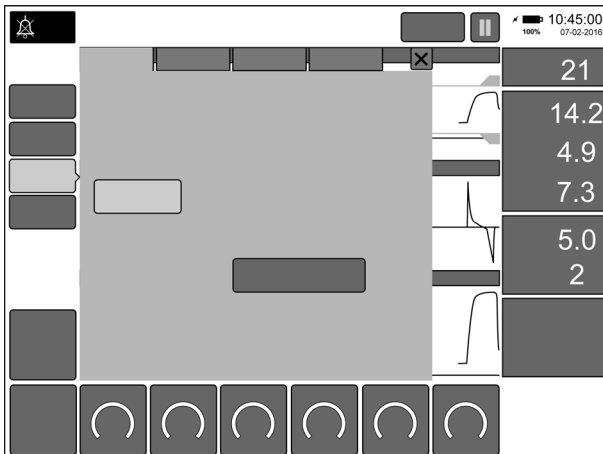

Note: When the flow sensor is connected the flow sensor calibration button is selected by default. When using the ventilator without the flow sensor only the one point O2 calibration is selected by default.

Note: The latest calibration date & time will be displayed above the button.

21.1.7.2 Sensors tab (with external sensor/s)

The sensor tab allows the user to calibrate the flow sensor or perform a one point O2 calibration.

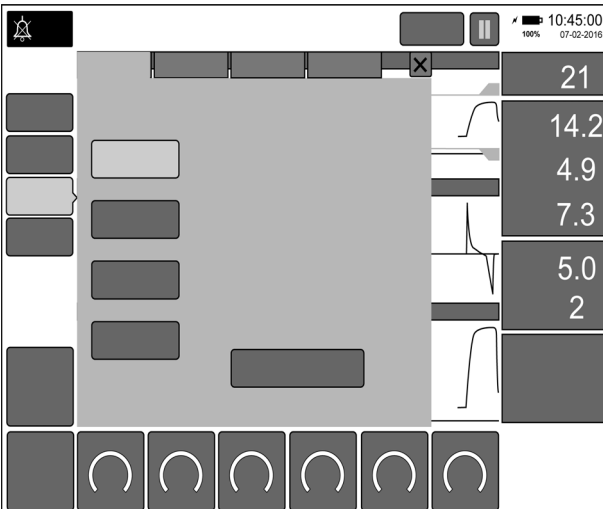

21.1.7.3 Brightness tab

The Brightness tab allows the user to select Day or Night mode and set the screen brightness for the these modes.

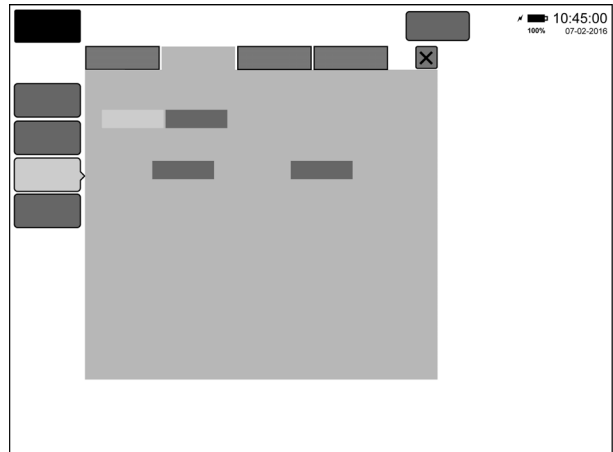

The user change the set percentage brightness for each mode as stated below.

Day mode: the default setting on at 70%
(Range 30% to 100%)

Night mode: the default setting on at 30%
(Range 20% to 60%).

Note: The day mode can only be decreased to 10% above the night mode setting. The night mode can only be increased to 10% below the day mode setting.

Note: Night mode is automatically cancelled on the activation of an alarm.

21.1.7.4 System Tab

The system tab allows the user to select from the following system related functions:

- Set date and time (O)
- User preferences (P)
- Engineering mode (Q)
- System information (R)
- Screen Calibration (S)
- System Update (T)

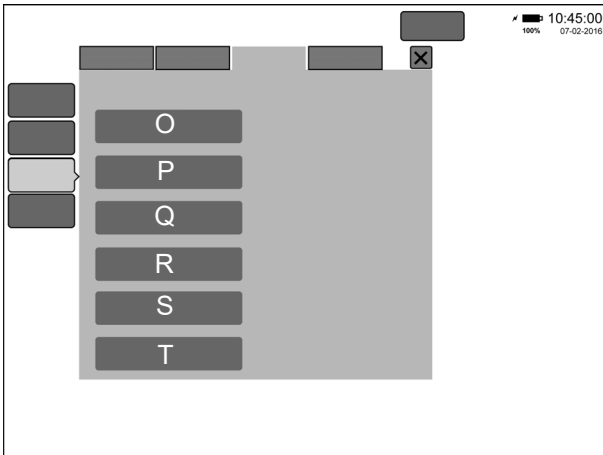

Note: Screen calibration menu may be disabled depending on ventilator screen type.

Caution. Only trained service personnel should access the engineering mode button Q, screen calibration button S, and system update button T. For information please consult the service manual. See chapter '47. Consumables & Accessories' on page 280 for service manual part number.

21.1.7.4.1 Set date and time

The set time and date button (O) allows the user to set the time and date for the ventilator.

Note: Daylight saving has to be manually set by the user when required.

1. Set the Date and date format
2. Set the time.

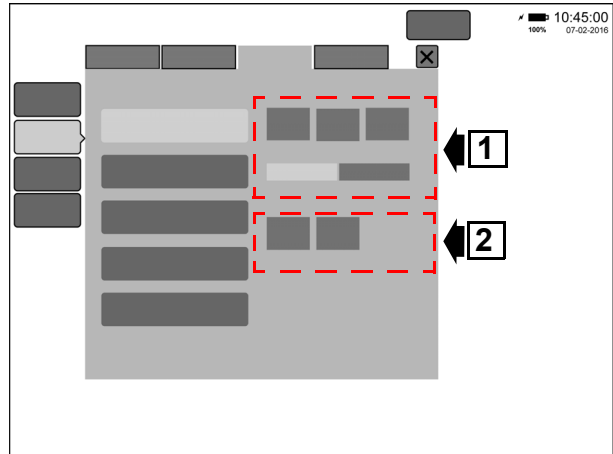

Note: Default date and time format defaults can be set through user preferences.

21.1.7.4.2 User preferences

The user preferences button (P) allows the user to set the start up-defaults for the ventilator.

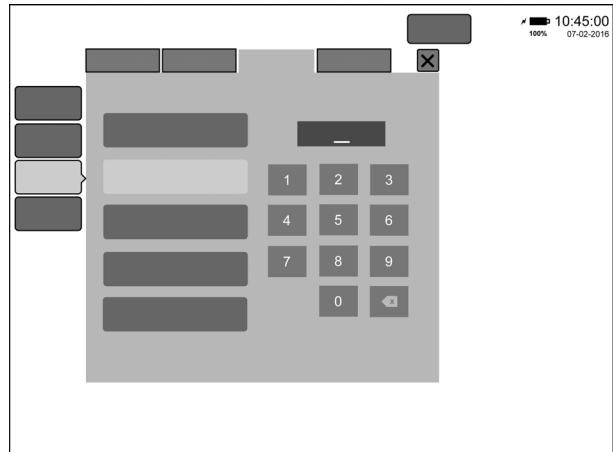

The access to the user preferences require the security code to be entered.

See "User preferences" on page 266 for detailed description.

21.1.7.4.3 System information

The system information button (R) displays ventilator system information.

The subsystem version numbers are used to determine the overall software version which is displayed on this panel. See chapter '37. Software version identification' on page 242 for further information on the software version.

Note: Display Board CPU vitals, Elapsed time from last service and input gas pressures are primarily for use by service personnel.

21.1.7.5 Data tab

The data tab allows the user to select from the following export related functions:

Patient log (U)

Events log (V)

Screen captures (W)

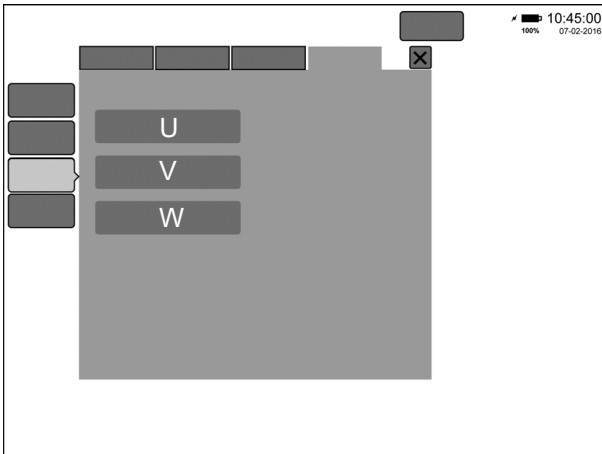

21.1.7.5.1 Patient log

The patient log button exports patient Trends, Waveforms, Alarm Log & Events Log.

Pressing the button (U) will display the "Start Export" button. If a USB memory stick is present the button will be active. See "SLE 6000 Event and Patient Log viewer software" on page 270 for further information.

21.1.7.5.2 Events log

The events log button exports the Events Log.

Pressing the button (V) will display the "Start Export" button. If a USB memory stick is present the button will be active. See "SLE 6000 Event and Patient Log viewer software" on page 270 for further information.

21.1.7.5.3 Screen capture

The screen capture button exports the last 10 screen captures.

Pressing the button (W) will display the "Start Export" button. If a USB memory stick is present the button will be active.

See how to take screen captures in section '21.2.15 Screen capture' on page 144.

21.1.7.6 Downloading screen captures

Turn on the ventilator and allow it to enter Standby mode.

Insert a USB memory stick into the data port at the rear of the ventilator.

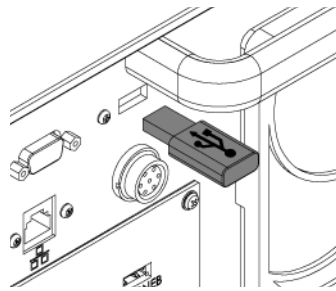

Note: There are two USB ports on the rear of the ventilator. Use the port indicated (Data Export).

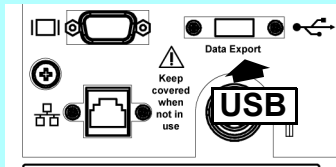

Activate the Utilities tabs (1) and select the Data tab (2).

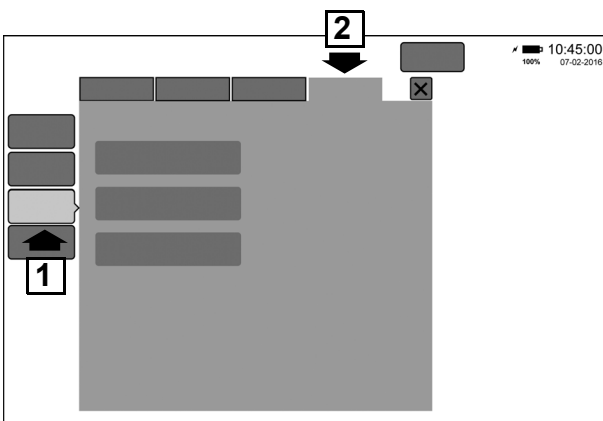

Select the Screen Captures button

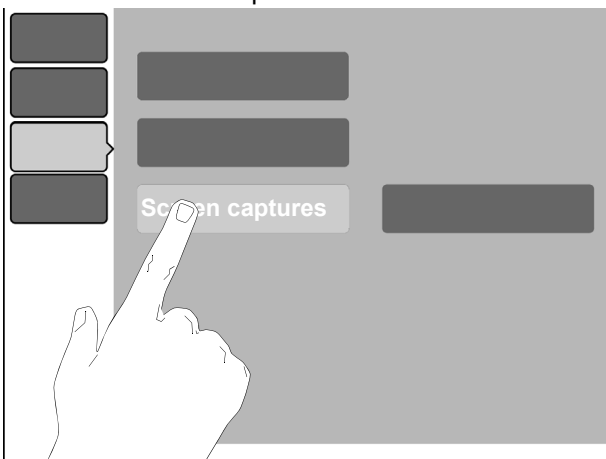

On selection of the Screen Captures button the "Start Export" button becomes active. Press the button to start the export to the USB memory stick.

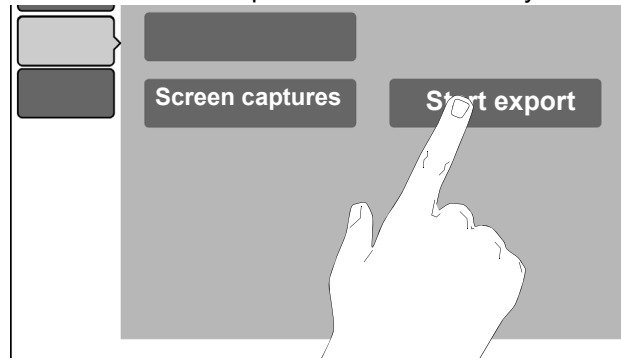

The ventilator will display a progress bar during the export process. Also displayed is a cancel button that allows the user to terminate the export process.

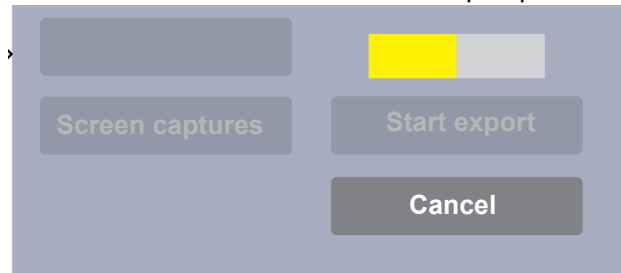

When complete the ventilator will indicate that the data export was OK.

Remove the USB memory stick from the ventilator. The SLE6000 creates a folder with a identification number that is unique to that ventilator.

Example: Ventilator ID 1001453795

Within the folder the user will find exported bitmap files.

Each file is prefixed with the date followed by serial code and then file type.

Example:

16_03_31_55929_ScreenCapture_00.bmp

Note: The ventilator does not overwrite any existing files but creates new files with a different serial code.

The ventilator will check the USB memory stick for enough free space for the new export files. If not enough free space is available the ventilator will display the following message "The USB stick does not have enough free space. Minimum XMB free space needed".

Note: If the user also exports the patient logs or event logs these will be located within the same folder.

The bitmaps can be viewed by most PC/MAC word processor or file viewer applications.

21.1.8 Layout Tab

The layout tab allows the user to select and configure the Waveform (W), Loops (X), Trend (Y) and SpO₂ (Z) layouts prior to entering a ventilatory mode.

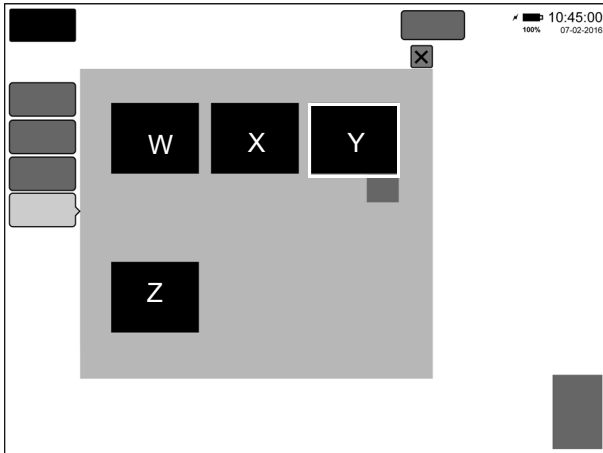

The default selection in Standby mode is Trends. To view trends in Standby mode press the Layout button and then the confirm button.

To modify one of the layout formats touch the required layout. The edit button will appear.

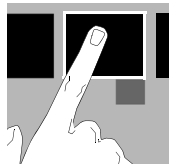

Press the edit button to enter the selected layout panel.

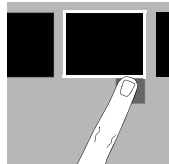

Note: Then ventilator will record the last layout selection and set it as the session default.

21.1.8.1 Waveforms

The waveform panel allows the user to configure the waveform panel in a ventilatory mode.

Note: The configured waveform panel is not visible in Standby mode.

Note: When the flow sensor is not connected the panel will show only the pressure waveform as the default.

The user can turn off two of the three available waveforms. The available waveforms are:

- Pressure (Default On)
- Flow (Default On)
- Volume (Default On)

The user can also change the style of the displayed trends.

Filled - when turned on fills in the waveform with colour.

Background - when turned on applies a time based grid to the background of all the waveforms.

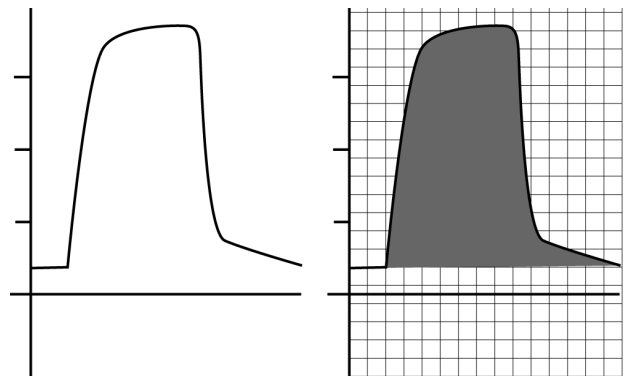

21.1.8.2 Loops

The Loops panel allows the user to configure the waveform panel in a ventilatory mode.

Note: The loops configured waveform panel is not visible in Standby mode.

Note: When the flow sensor is not connected, the panel will show only the pressure waveform as the default.

The Waveform panel is configured when loops are selected into 1 waveform (1), 1 primary loop (2) and 1 secondary loop (3).

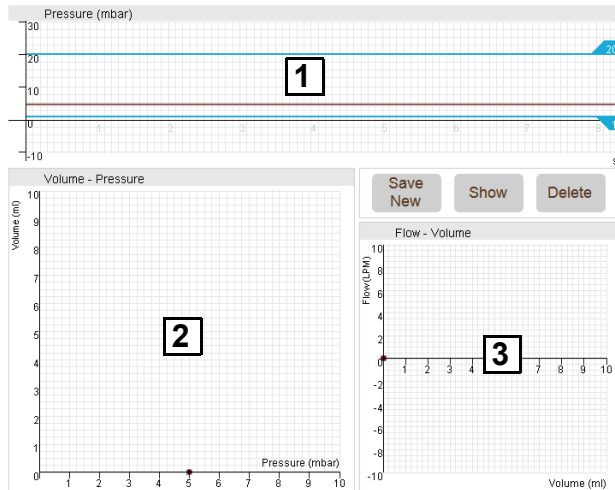

The waveform (1) can be configured to display.

- Pressure (Default)
- Flow
- Volume

The primary loop (2) can be configured to display.

- Flow against Volume - F/V
- Flow against Pressure - F/P
- Volume against pressure - V/P (Default)

The secondary loop (3) can be configured to display.

- Flow against Volume - F/V (Default)
- Flow against Pressure - F/P
- Volume against pressure - V/P

21.1.9 Capturing, Retrieving & Deleting Loops.

21.1.9.1 To capture Loops

In the main waveform window two loops will be displayed, the primary and secondary.

Press the "Save" button. The current loops are saved. The ventilator will display the time and date as the loops are saved to memory at the top of each loop.

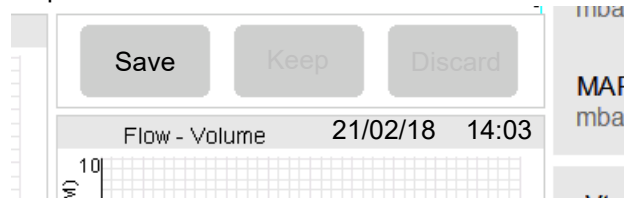

Two new buttons become active "Keep" and "Discard".

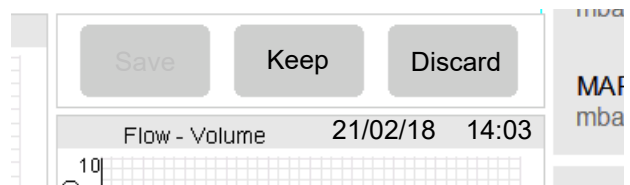

Press "Discard" to erase the stored loops the user will return to the initial "Save" button.

Press the "Keep" button to save the loops. On pressing the "Keep" button two new buttons will appear.

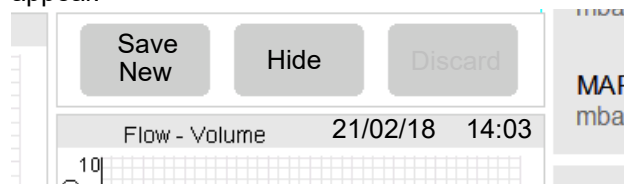

The saved loops are displayed in white.

Note: When viewing a stored loop the active loops are shown as blue lines.

Pressing "Hide" will remove the saved loop from the loop display areas. Two new buttons become active "Show" and "Delete".

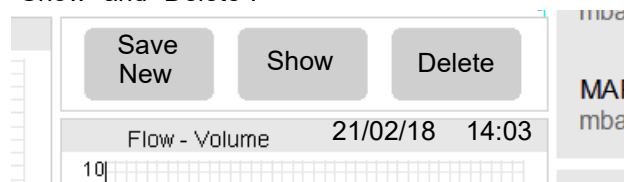

Press "Show" to retrieve and display the saved loops.

Press "Delete" to erase the saved loop from the memory..

Note: The user cannot see the loop to be deleted.

Pressing "Save New" the current loops are saved and the "Keep" and "Discard" buttons will reappear.

21.1.9.2 Trends

The trends are the only option that will be displayed in Standby mode.

The user has the choice of displaying up to eight trends simultaneously in four displays lines. Each display line can show a maximum of two trends.

The ventilator stores 14 days of trend data for each of the trends listed below.

The trend data is retained after powering down the unit or after a total loss of power.

The trends available in each display line are:

- O₂
- Set O₂
- PIP
- PEEP
- MAP
- CPAP
- ΔP
- Vte
- Vmin
- RR
- Triggers
- Resistance
- Compliance
- DCO₂
- SpO₂
- SIQ

Note: The user can display the same trend twice in one display line. The selection of trends is not affected by the connection or disconnection of the flow sensor.

The default selection for Standby mode¹:

Display line 1: PIP/PEEP

Display line 2: O₂/Off

Display line 3: MAP/Off

Display line 4: Off/Off

Note¹. The defaults for display line 1 in a ventilatory mode is different. The default is Pressure (Live)/Off. Pressure (Live) is not a trend but the pressure waveform in real time.

Caution. Setting the defaults in Standby mode will override the defaults of the ventilatory mode trends. If a trend is selected for Display line 1 no real time waveforms will be displayed on entering a ventilatory mode.

21.1.9.2.1 Setting default trends.

From the Trends Edit panel select the display line to be modified.

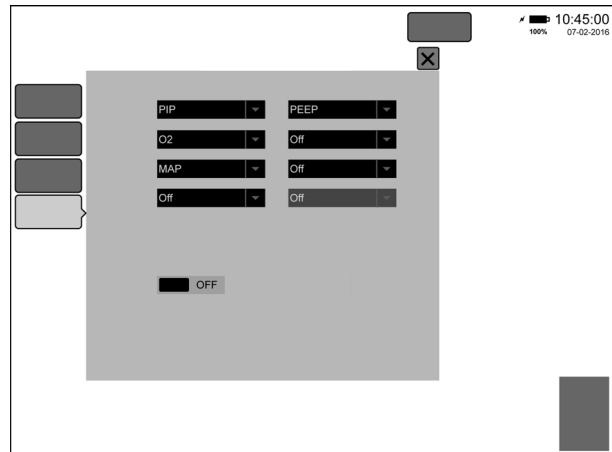

This will activate a drop down menu.

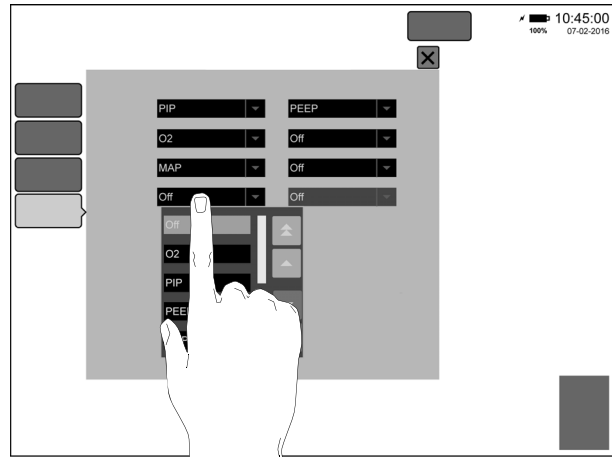

The drop down menu lists all the trend data that can be displayed for that line.

The user can scroll down by using single arrow button (1).

The user can jump to the end of the list by pressing double arrow button (2).

When the user has moved away from the top of the list the up buttons (3 & 4) become active.

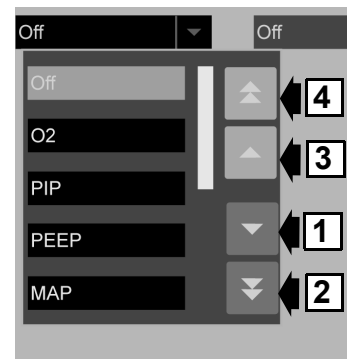

Touch the required trend to select.

Repeat the process for other display lines.

To cancel the selection press the Layout button.

To confirm the selection press the confirm button.

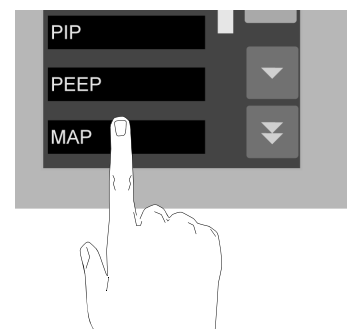

The Trend panel has one Style related control, Background.



Background (5) - when turned on applies a time based grid to the background of all the trends.

21.1.9.3 Single & double trend display

When a single trend is required for a display line the trend window will display the trend as a blue line. When two trends are displayed in the same display line the second trend is orange and overlaid on top the first.

21.1.9.4 Viewing trends

After setting the required trend views as previously described, press the confirm button to view the trends in the waveform windows.

The associated trend view controls will now become active. These are located in the lower right hand corner of the waveform windows.

Displayed are the Zoom (A), Cursor (B) and Scroll (C) buttons. The trend start time (D). The set zoom magnification (E). The trend window locator bar (F).

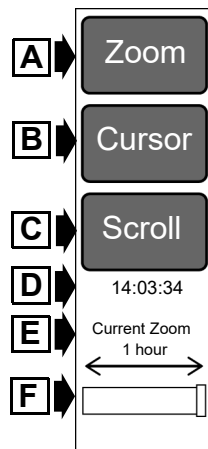

When selecting Zoom, Cursor or Scroll the cursor line and trend value box becomes active for each trend window.

The values displayed in each box are coloured and correspond to the trend of the same colour for that window.

The values are for the points that the cursor line intersects the trend line.

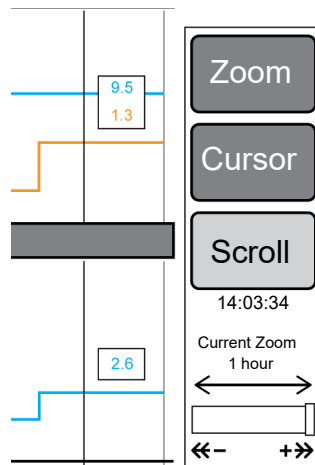

If only one trend has been selected for a particular window only one value is shown.

21.1.9.4.1 Zoom

The Zoom function increases or decreases the magnification of the trend window time scale.

The zoom button when touched activates the plus and minus buttons.

The plus and minus buttons are used to increase/decrease the magnification. Also displayed in the bottom part of the panel are two icons that link the plus/minus buttons to the level of magnification.

The default time view for all the windows is 1 hour. Decreasing the zoom magnification is limited to predefined steps of 2, 4, 6, 9, 12 & 24 hours. Increasing the zoom magnification is limited to predefined steps of 30 and 15 minutes.

As the magnification is increased the cursor in the trend window locator bar will increase or decrease dependant on the zoom period.

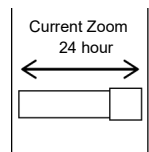
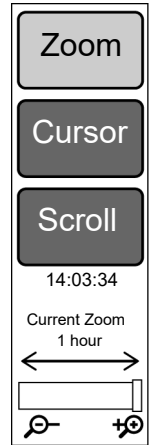

21.1.9.4.2 Scroll

The scroll function allows the user to move the cursor line through the 14 days of trend data at the set magnification.

The scroll button when touched activates the plus and minus buttons. Also displayed in the bottom part of the panel are two icons that link the plus/minus buttons to the direction of movement.

As the user scrolls into the trend history the trend window locator bar moves accordingly.

The date will appear as the previous days trend data is entered.

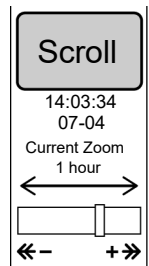
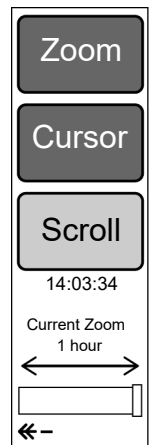

21.1.9.4.3 Cursor

The cursor function allows the user to move the cursor line through the current displayed trend window.

The cursor button when touched activates the plus and minus buttons. Also displayed in the bottom part of the panel are two icons that link the plus/minus buttons to the direction of movement.

Moving the cursor line to beyond the end of the window will move the line to the beginning of the next time window.

Time windows are dictated by the Zoom magnification.

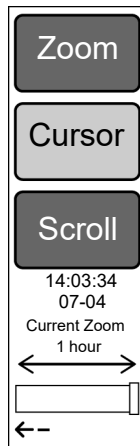

21.2 Ventilation mode

For the purpose of this section the user interface will be described in generic terms unless otherwise specified.

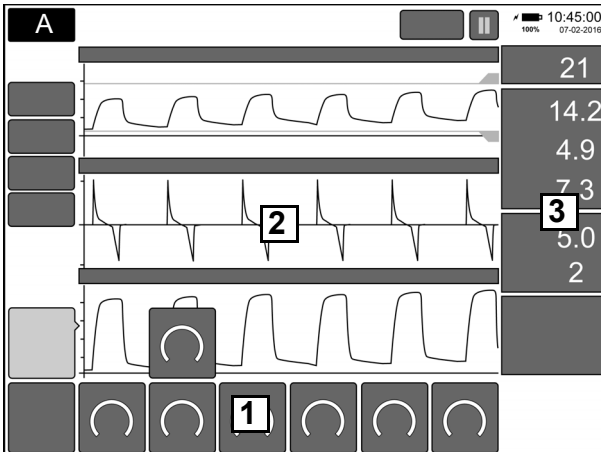

1. Parameters (Main and additional)
2. Waveform panel
3. Monitored values

The other areas are as per Standby mode.

21.2.1 Alarm mute and pre-mute button (A)

The alarm mute/pre mute button allows the user to pre-mute all the mutable alarms that may be generated or mute an active patient alarm.



The period that the audio component of the alarm is paused for in both scenarios is 120 seconds. The mute time counts down to zero (The time is displayed in minutes and seconds).



21.2.2 Parameters

21.2.2.1 Parameter types

Time based controls [Blue]

RR, Ti, Ti Max, Frequency, I:E ratio

Pressure/Volume controls [Orange]:

CPAP, PIP, PIP Max, MAP (in HFOV), PEEP, VTV, ΔP (in HFOV), Flow/Fresh Gas (Oxygen Therapy)

Oxygen [Green]

Additional Parameters [Blue]:

Rise Time, Backup RR, Sigh RR, Sigh Ti

Additional parameters [White]:

Trigger Sensitivity, Termination Sensitivity

Additional parameters [Orange]

P support, Sigh P (in HFOV)

21.2.2.2 Parameter states

All the parameters have three states, available preview, available active mode and selected.

A selected button is White.

An available preview button is black with a white border.

An available button is dark grey.

21.2.2.3 Modifying a parameter

Touch the parameter required.



This will activate plus/minus buttons.



Use the plus/minus buttons to adjust the parameter. After the first adjustment the confirm button will appear.

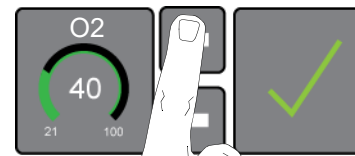

Note: If no action is taken the selection is cancelled after 15 seconds.

Press the confirm button to accept the change.

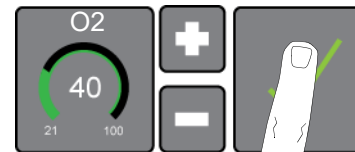

21.2.2.4 Turning "ON" a parameter function

Some parameters are inactive until turned on. Any inactive parameter has the text OFF in the centre of the eyebrow.



Press and hold the parameter for 2 seconds.



The plus/minus buttons and the confirm button will appear.



The user can adjust the parameter and then confirm the setting or just confirm the activation of the parameter and then adjust the parameter as previously described in section 21.2.2.3.

Note: If no action is taken the selection is cancelled after 15 seconds.

21.2.3 Preview mode

The User presses the Mode button and the mode panel appears.

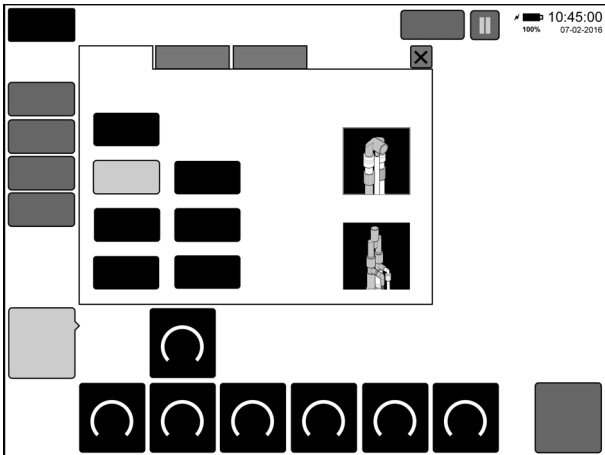

By default, the Invasive tab will be selected on startup, unless the user has pre-selected the non-invasive tab as a default in the user preferences.

If already in a mode of ventilation, pressing the mode button will bring up the mode panel with the associated tab of the current mode.

On startup, the mode of ventilation that has been chosen in the user preferences will be pre-selected. By default (factory default) this selection will be set to 'Invasive tab'. The selected mode button shall be in 'Selected' state, all others shall be in 'Available' state.

The user selects the ventilation mode of choice; The controls of the selected mode shall appear within the menu in 'preview' mode.

When already in a mode of ventilation, the settings shall be the same as in the current mode, whenever settings are common.

In preview mode, the Confirm button will be available at all times.

The user adjusts the ventilator parameters. Presses parameter to be adjusted.

Parameter changes to 'selected' state.

User uses plus/minus keys to change the parameter value.

User presses a different parameter.

Previously pressed parameter returns to "available" mode, but the parameter remains at the last adjusted value. New parameter changes to "selected" state.

User repeats process with other parameters if required.

When the user is ready pressing the confirm button accepts all the changes to the parameter controls and activates the chosen mode.

The above procedure can be used when the user wants to change more than one parameter at once, while remaining in the same mode of ventilation.

21.2.4 Patient circuit selection

The invasive mode panel contains two buttons that allow the user to select between 10mm and 15mm diameter patient circuits.

Patient Circuit 10mm

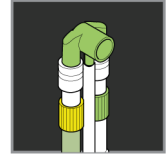

For patients requiring tidal volumes of less than 50ml use either: **10mm**

15mm

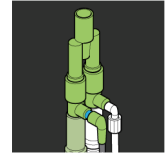

For patients requiring tidal volumes of greater than 50ml use: **15mm**

Note: The selection of 15mm patient circuits is only available for invasive ventilation. Changing to non-invasive ventilation automatically selects 10mm patient circuits.

21.2.5 Monitored values

21.2.5.1 Single column/double column layout

The monitored values area to the right of the waveform layout has two display options. Single column with large numbers and dual column with smaller numbers.

In single column mode the area displays a maximum of 8 monitored values.

In double column mode the area displays a maximum of 16 monitored values.

21
14.2
4.9
7.3
5.0
2

21.2.5.1.1 Switching between layouts

The factory default is single column. The default layout is set from user preferences, see "Interface tab" on page 268. Through user preferences the user can set the user default to double column.

Which ever layout is selected the user in a ventilatory mode can switch between modes by touching the panel for 1 second.

30	21
0.40	14.2
1.60	4.9
1:40	7.3
0.1	5.0
0.3	2
108	

21.2.6 Alarms tab - ventilatory mode

Selecting the alarm panel will now show all active alarm thresholds.

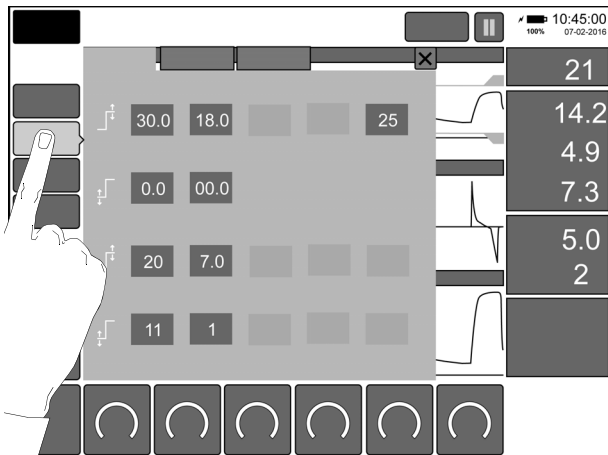

The number of alarms thresholds will vary dependant on the mode selected or the number of selected sensors connected.

Note: Alarm threshold auto track the associated parameter control. Adjust alarm thresholds after ventilations parameter have been set.

Note: Selecting a ventilatory parameter will automatically cancel the alarm panel and discard any unconfirmed alarm threshold changes.

21.2.6.1 Adjusting an alarm threshold

Select the alarm panel. Touch the threshold that requires adjustment.

The threshold will change colour to show that it has been selected.

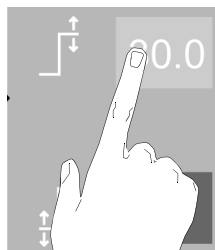

To adjust the threshold use the plus minus buttons.

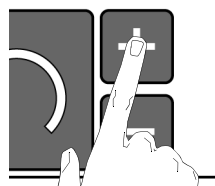

Press the confirm button when threshold set.

Note: Each threshold change has to be confirmed independently.

Note: Selecting a new threshold without confirming the changes to the previous threshold change will cause the previous threshold setting to be discarded.

21.2.6.2 Alarm auto tracking/auto set thresholds

The following alarms auto track the ventilation parameters.

21.2.6.2.1 Invasive Conventional

Vte:

VTV Off:

High = 30 ml

Low = 0 ml

VTV On:

Below 10 ml

High = 130% of set value - minimum 3ml above set

Low = 10% of set value

Above 10ml

High = 30% above set

Low = 10% below set

Vmin:

VTV Off:

High = 18 L

Low = 0 L

VTV On:

High = 200% of (Vte x RR)

Low = 50% of (Vte x RR)

RR

Default = 100 BPM

Apn time

Default = 15 seconds

Leak

Default = 25%

PIP

High = 5 mbar above set PIP

Low = 70% of the set PIP for the PIP pressures between 8 mbar and 16 mbar,

5 mbar below the set PIP for PIP pressures between 17 and 50mbar

90% of the set PIP for PIP pressures between 51 and 65 mbar

CPAP

High = 5 mbar above set CPAP

Low = 5 mbar below set CPAP or 1 mbar if PEEP set to 6 mbar or lower

PEEP

High = 5 mbar above set PEEP

Low = 5 mbar below set PEEP or 1 mbar if PEEP set to 6 mbar or lower

21.2.6.2.2 Invasive oscillatory

HFOV High PIP (High Paw)

High = 10 mbar above MAP + ($\Delta P \div 2$)

HFOV+CMV High PIP (High Paw)

High = 10 mbar above PIP + ($\Delta P \div 2$)

HFOV Low Paw (Low Pressure)

Low = 10 mbar below MAP - ($\Delta P \div 2$)

HFOV+CMV Low Paw (Low Pressure)

Low = 10 mbar below PEEP - ($\Delta P \div 2$)

21.2.6.2.3 Non invasive Conventional

RR

Default = 100 BPM

Apn time

Default = 15 seconds

Leak

Default = 25%

PIP

High = 5 mbar above set PIP

Low = 70% of the set PIP for the PIP pressures between 8 mbar and 16 mbar,

5 mbar below the set PIP for PIP pressures between 17 and 50mbar

90% of the set PIP for PIP pressures between 51 and 65 mbar

CPAP

High = 5 mbar above set CPAP

Low = 5 mbar below set CPAP or 1 mbar if PEEP set to 6 mbar or lower

PEEP

High = 5 mbar above set PEEP

Low = 5 mbar below set PEEP or 1 mbar if PEEP set to 6 mbar or lower

21.2.6.2.4 Non invasive oscillatory

HFOV High PIP (High Paw)

High = 10 mbar above MAP + ($\Delta P \div 2$)

HFOV Low Paw (Low Pressure)

Low = 10 mbar below MAP - ($\Delta P \div 2$)

21.2.7 History and Loudness

These tabs operate as described in “History tab” on page 130 and “Loudness tab” on page 130.

21.2.8 Utilities tab - ventilatory mode

Selecting the utilities panel will now show the sensor tab.

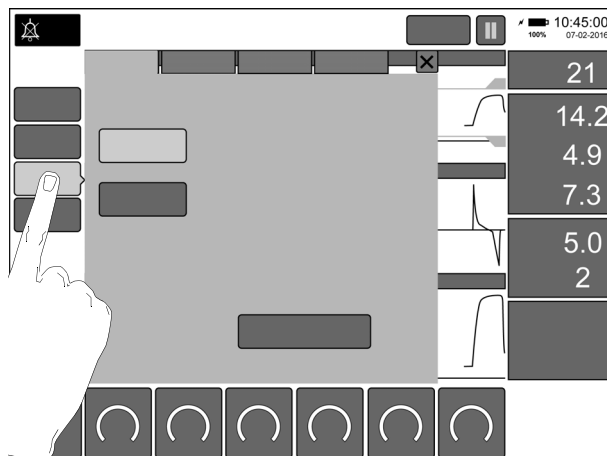

The user can select between calibrating the flow sensor or the oxygen system (100%).

Note: If using the ventilator without a flow sensor connected the Flow Sensor button will not be present.

21.2.8.1 Flow sensor calibration

Caution. The flow sensor will have to be removed from the patient circuit.

Occlude the flow sensor to prevent any flow across the sensor wires.

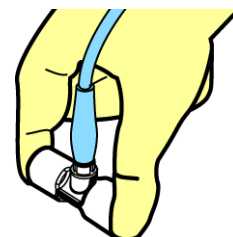

Caution: To avoid contamination of the flow sensor use gloves when calibrating .

Press the Start calibration button.

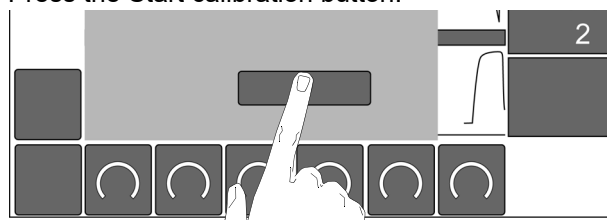

The text “Calibrating..” will appear above the button.

The ventilator will sound a medium priority alarm and display the alarm message “Calibrate Flow Sensor.”

When calibrated the button returns to its unpressed state and the text “Calibration Completed.” will appear.

Note: The Flow Sensor button has no default setting. If the O₂ calibration was the last used this will be selected.

21.2.8.2 O₂ calibration

Select O₂ button.

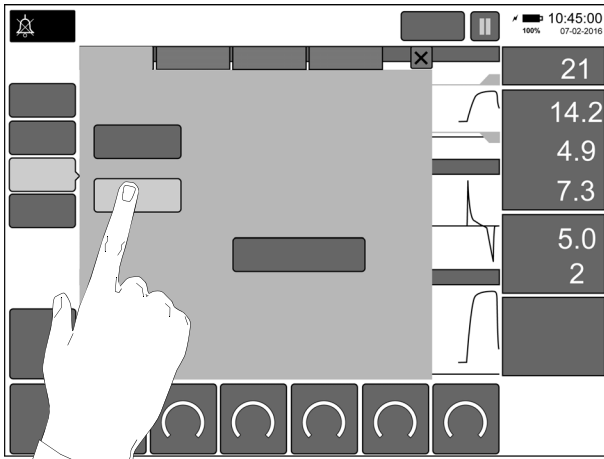

Press the “Start One Point O₂ Calibration”.

The text “Calibrating..” will appear below the button and the O₂% measured value will display the text “CAL”.

The calibration will take approximately 4 minutes.

The user can still set the O₂% during the calibration.

Note: The O₂ calibration button has no default setting. If the Flow Sensor was the last used this will be selected.

Note: The O₂ (%) trend will not display any reading during the automatic oxygen calibration routine.

21.2.9 Brightness tab - ventilatory mode

See “Brightness tab” on page 131.

21.2.10 System tab - ventilatory mode

The system tab has only two active buttons in a ventilatory mode. Set Date and time and System information. All the other buttons are only available when in Standby mode. See “Set date and time” on page 132 and “System information” on page 133 for more details.

21.2.11 Data tab - ventilatory mode

The buttons are only available when in Standby mode. See “Data tab” on page 133.

21.2.12 Layout

The layout tab allows the user to select and configure the Waveform, Loops and Trend layouts. The function is the same as in “Standby” mode, see “Layout Tab” on page 135.

21.2.13 Lock screen button

The “Lock Screen” button is available when no alarms are active. Pressing the button will lock the screen.

The “Padlock” Icon will be displayed on the button to show that the screen is locked.

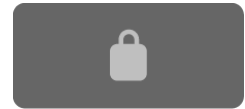

When locked all areas apart from the Lock screen button are inactive.

In the event that an alarm is activated the screen is automatically unlocked.

Note: In an alarm condition the lock screen button becomes the alarm message “Reset” button.

Pressing the screen when locked will bring up the information message “Screen is locked” and the padlock icon will change colour to yellow.

To unlock the screen the user will have to press and hold the button for 1 second.

21.2.14 Pause/play

When in any ventilatory mode the pause button will be available. The pause button will pause the graphics section for 120 seconds.



To restart the graphics section the user will have press the play button.



21.2.15 Screen capture

When in any ventilatory mode the pause or play button when touched and held for 3 seconds, will create a copy of the screen and store it in the screen capture log.



The screen capture log holds a maximum of 10 screen captures.

When the log is full the oldest screen capture is discarded to create space for the new capture.

Screen captures can only be downloaded in “Standby mode”. See “Downloading screen captures” on page 134 for more information.

21.2.16 Alarm bar

In the information area the alarm bar will be displayed during an alarm condition.



The alarm bar will display the highest priority alarm message. This is coloured red/amber/cyan when the alarm condition is active.

The alarm bar is accompanied by the flashing light bar and the high priority audile signal.

If the alarm condition clears with out a user interaction the bar will change colour to cyan.

When the alarm bar is active the lock screen button changes function to become the alarm reset button.

If the alarm condition has cleared pressing the reset button will clear the alarm bar.

When no alarm conditions are active the information area can display 1 of the following messages:

- Screen is locked
- To unlock, press and hold for 1 second
- Graphics Section paused Paused 120 secs

21.2.17 Mode specific controls

21.2.17.1 Manual breath (Inspiratory Hold)

The manual breath button appears in the following invasive modes, CPAP, CMV, PTV, PSV, SIMV and dual/single limb non invasive modes, nCPAP, NIPPV.

21.2.17.1.1 Manual breath

Pressing the manual breath button will deliver a mechanical breath at the set PIP and Ti.

21.2.17.1.2 Inspiratory Hold

Pressing the inspiratory hold button will deliver a mechanical breath at the set PIP for a maximum of 5 or 10 seconds. The time period is set through the User Preferences. The set Ti is ignored.

21.2.17.2 Sigh (Sigh Hold)

The Sigh button appears in the following invasive mode, HFOV and dual limb non invasive mode nHFOV.

21.2.17.2.1 Sigh

Pressing the Sigh button will deliver an oscillatory pause at the set Sigh P and Sigh Ti.

21.2.17.2.2 Sigh Hold

Pressing the Sigh hold button will deliver an oscillatory pause at the set Sigh P for a maximum of 5 or 10 seconds. The time period is set through the User Preferences. The set Sigh Ti is ignored.

21.2.18 Oscillation Pause

The Oscillation Pause button appears in the following invasive mode, HFOV and dual limb non invasive mode nHFOV.

Pressing the Oscillation Pause button will deliver an oscillatory pause at the set MAP for a maximum of 60 seconds. Re-pressing the button during the 60 seconds will cancel the pause.

21.2.19 HFO Activity

The HFO activity button only appears in the invasive HFOV+CMV mode. The HFO activity button allows the user to toggle between oscillations in the inspiration and expiration phases or just the expiratory phase.

Touch the Additional Parameters button. This will activate the HFO activity button.

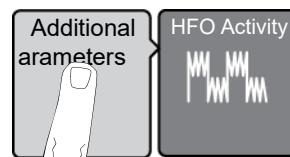

Touch the HFO activity button.

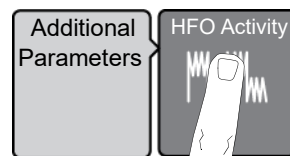

The activity indicator will replace the button.

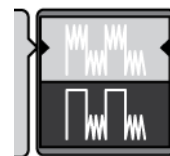

This will activate plus/minus buttons. Use the plus/minus buttons to toggle between oscillations in the inspiration and expiration phases or just the expiratory phase. Press the confirm button to accept the change.



The indicator will change to the new oscillation activity.

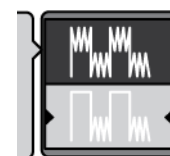

This page is intentionally left blank.

Technical Data

- “Technical description” on page 148
- “Oxygen Calibration Routines” on page 151
- “N5402-REV2 & N5302 flow sensor” on page 152
- “Technical specification” on page 154
- “Sensor Specifications” on page 190
- “Alarms” on page 194
- “Cleaning and disinfection” on page 235
- “EMC compliance” on page 237
- “Pneumatic unit diagram” on page 239
- “Installation instructions” on page 260



22. Technical description

The ventilator is a computer controlled ventilator. The computer is divided into three main electronic subsystems that are housed in the upper (electronic) section of the ventilator.

The three sub systems are user interface, monitor and controller.

The user interface subsystem controls the user interface, the display and the touchscreen.

The controller subsystem regulates the pneumatic systems of the ventilator.

The monitor subsystem collects and processes flow data and generates the alarms.

Each subsystem communicates with the other two in a peer to peer protocol, i.e. no subsystem is in complete control.

A communications module that integrates with the user interface and the monitor known as the ESMO provides connectivity for the Masimo SpO₂ and Covidians etCO₂ external sensors.

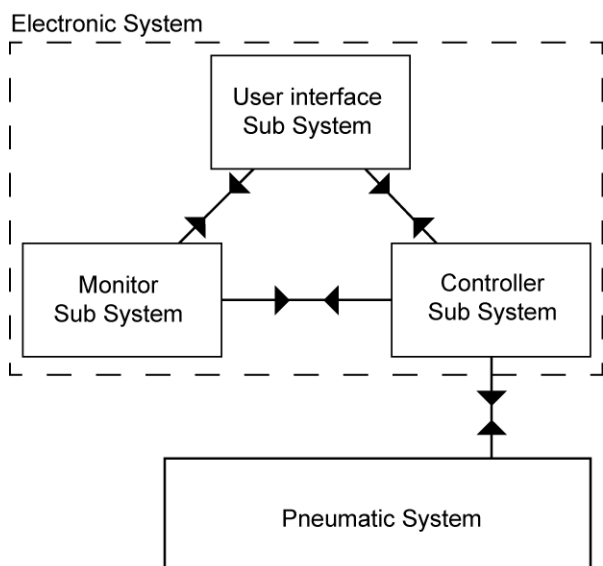

The ventilator is fitted with an auto-ranging power supply that is capable of working with mains supplies of 100V to 240V 50-60 Hertz.

The ventilator can also run from an external 24V DC input.

The ventilator carries an onboard backup power source, which consists of two Lithium Ion battery packs, that can power the ventilator in the event of a mains power fail.

The batteries are charged from the ventilators power supply. Internal battery power, 24V DC and mains power supply are monitored by the ventilators other subsystems.

In normal modes of ventilation and with a fully charged battery, in a mains power fail situation the

ventilator will continue to operate on its reserve power supply.

The pneumatic system consists of the following:

An electronic oxygen blender blends the gas. The blended gas is then controlled via solenoid valves to supply the conventional ventilation system and the oscillatory system.

For conventional ventilation the gas is controlled by two pressure regulators that produce positive and negative gas flows via the forward and reverse jets.

For oscillatory ventilation the gas flow is controlled by four in-line high speed solenoid valves that produce the oscillatory gas flow via the forward and reverse jets.

The exhalation block mounts onto two jet ports one forward/reverse and one mean pressure.

Pressure is monitored via the proximal airway port through a pair of pressure transducers with data being sent to the monitor subsystem.

Flow is monitored by a dual hot wire anemometer mounted at the ET manifold with the flow data being sent to the monitor subsystem.

Invasive modes shall utilize a two limb patient circuit but non-invasive ventilation can be carried out either on a two limb or on a single limb circuit. In two limb circuit operation one limb is connected to the fresh gas port and the other is connected to the exhalation port.

The primary method of generating the patient pressure in two limb use is from the driving jets in the exhalation port.

A single limb non-invasive patient circuit is connected to the fresh gas port so all patient pressure control is achieved by directly controlling the fresh gas flow.

The exhalation port on the ventilator is not connected to the patient circuit. An increase in fresh gas flow increases the patient pressure dependent on the pneumatic resistance of the exhalation 'limb' of the single limb circuit (a single limb circuit still has an exhalation limb or port but it is not connected to the ventilator).

The patient pressure is monitored and the fresh gas is controlled to maintain the desired patient pressure.

The ventilator has two dedicated 5V inputs for etCO₂ and SpO₂ monitoring.

SpO₂ can be monitored using Masimo SET SpO₂ sensors. These must be connected to the SLE uSpO₂ cable.

etCO₂ can be monitored using Microstream™ technology using the Covidian MicroPod™

23. Description of ventilatory modes (Invasive)

The ventilator has the ability to be used as either a pressure controlled, volume targeted ventilator, as a pressure limited, time cycled ventilator, and as a high frequency oscillation ventilator.

23.1 CPAP

Continuous positive airway pressure

The ventilator generates a continuous positive airway pressure at a level set by the User. The apnoea alarm will sound if the patient has not made any breath attempts within the set apnoea period.

The ventilator will provide backup breaths if required.

23.2 CMV

Continuous Mandatory Ventilation

In this mode the inspiratory cycle is initiated by the ventilator at a set BPM rate. The breaths are time cycled.

23.2.1 CMV & VTV

This is as for basic CMV where the inspiratory pressure shall be controlled by the ventilator to achieve the user set VTV.

23.3 PTV

Patient Triggered Ventilation

In this mode all the patient's breath attempts are pressure supported. Mechanical breaths are delivered at the set parameters (Ti, PEEP and PIP) if no patient effort is recognised.

23.3.1 PTV & VTV

This is as for basic PTV where the inspiratory pressure shall be controlled by the ventilator to achieve the user set Vte (for assisted breaths).

23.4 PSV

Pressure Supported Ventilation

This is a pressure limited mode of ventilation in which each breath is patient triggered and supported. The breath is patient triggered, pressure supported and patient terminated. The infant therefore has control of the whole cycle, i.e. the inspiratory time and frequency. This form of ventilation is dependant on the use of a flow sensor placed between the ET tube connector and the patient circuit. Changes in flow or volume signal detects spontaneous breathing.

The termination sensitivity is also user adjustable from 0% - 50%.

Example: 5% termination sensitivity means that the pressure support will terminate when the inspiratory flow drops to 5% of the peak value. The level of pressure support can be manually adjusted by use of the PIP parameter control.

PSV can be used in the weaning process. Weaning is achieved by reducing the support level as the infant is able to make more effort.

In this mode all the patient's breath attempts are pressure supported, but mechanical breaths are delivered at the set parameters (Ti, PEEP and PIP) when a patient effort is recognised.

23.4.1 PSV & VTV

This is as for basic PSV with Apnoea Support, where the inspiratory pressure shall be controlled by the ventilator to achieve the user set VTV (for assisted breaths).

23.5 SIMV

Synchronised Intermittent Mandatory Ventilation

The frequency of mandatory breaths is determined by the BPM control. When a mandatory breath is due an assist window opens and waits for a patient's inspiratory effort. When this occurs the ventilator delivers a synchronised breath (SIMV breaths). Once the breath has been delivered the assist window closes until the next set breath is due.

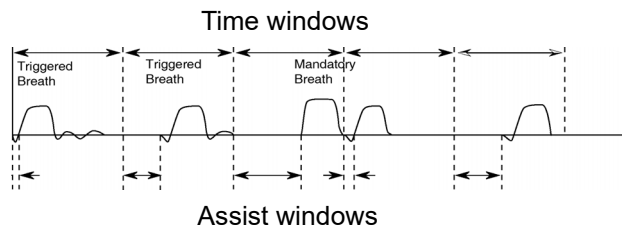

If the ventilator does not see a patient's attempt to breathe before the end of the defined time window then a mandatory breath is delivered. The mandatory breath point is the Time Window minus the Inspiratory Time.

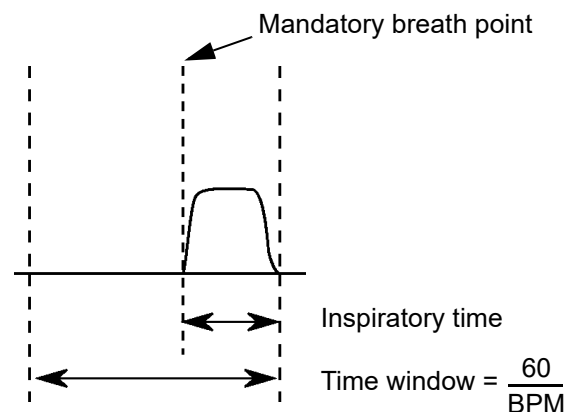

23.5.1 SIMV with P Support

SIMV with P Support allows the user to select the termination sensitivity and pressure support level on non SIMV breaths. Once a mechanical breath is delivered to the patient, the flow to the infant rapidly peaks and then decelerates to the termination threshold, inspiration ends and expiration can begin.

SIMV with P Support produces time cycled, pressure limited breaths that are delivered at a set BPM rate. Any additional patient breath attempts are pressure supported (Flow cycled, pressure limited).

23.5.2 SIMV & VTV

This is as for basic SIMV (with or without P Support), where the inspiratory pressure shall be controlled by the ventilator to achieve the user set VTV (for assisted breaths).

23.6 HFOV**High Frequency Oscillation**

In this mode, the ventilator shall deliver continuous high frequency oscillation. Small tidal volumes are delivered at super physiological rates.

23.6.1 HFO & VTV

This is as for basic HFO but automatically adjusts the ΔP , in order to achieve the target Vte, set by the user.

23.7 HFOV+CMV

A combination of oscillations during the expiratory or inspiratory & expiratory phase of a time cycled, pressure limited breath in CMV mode.

24. Description of ventilatory modes (Non-invasive)

The ventilator has the ability to be used as a pressure limited, time cycled ventilator, and as a high frequency oscillation ventilator. Using dual or single limb delivery circuits.

Note: O₂ therapy is delivered by single limb delivery circuit only.

24.1 nCPAP (Dual and Single limb)**Nasal Continuous positive airway pressure**

The ventilator generates a continuous positive airway pressure at a level set by the User. The apnoea alarm will sound if the patient has not made any breath attempts within the set apnoea period.

The ventilator will provide backup breaths if required.

24.2 NIPPV (Dual limb)**Non-Invasive Intermittent Positive Pressure ventilation**

In this mode the inspiratory cycle is initiated by the ventilator at a set BPM rate. The breaths are time cycled.

24.3 NIPPV Tr. (Dual limb)**Non-Invasive Intermittent Positive Pressure ventilation Triggered**

In this mode all the patient's breath attempts are pressure supported. Mechanical breaths are delivered at the set parameters (Ti, PEEP and PIP) if no patient effort is recognized.

24.4 nHFOV (Dual limb only)**Nasal High Frequency Oscillation**

In this mode, the ventilator shall deliver continuous high frequency oscillation.

24.5 O₂ Therapy (Single limb only)

In this mode, the ventilator shall deliver continuous flow at the set oxygen concentration.

25. Oxygen Calibration Routines

The ventilator has two oxygen cell calibration routines. The first calibration is the 100% oxygen calibration (one point). This calibration is carried out at the following intervals after the unit is turned on: start up, 10 minutes, 30 minutes, 60 minutes, 90 minutes and then at 8 hourly intervals.

The second routine is the 21% and 100% oxygen calibration (two point). This calibration should only be carried out if the oxygen cell has been replaced or has registered below 21% (cell drifting with age).

Warning: The user cannot carry out the two point calibration whilst connected to a patient. The ventilator has to be placed in "Standby" mode and the calibration process will deliver 21% O₂ to the patient for 3 minutes.

25.1 One Point O₂ Calibration

The user can carry out a one point calibration of the system by accessing the oxygen sensor calibration panel from the services panel.

The ventilator can be connected to a patient for this calibration.

The ventilator will continue to deliver the user set percentage of O₂ during calibration.

The O₂ measured value will read "CAL".

Note: The ability to carry out a one point O₂ calibration is only available when the ventilator is set to a ventilatory mode.

25.2 Two Point O₂ Calibration

The two point calibration routine can only be performed from the Engineering mode.

Caution. Only trained service personnel should access the engineering mode. For information on Engineering mode please consult the service manual. See chapter '47. Consumables & Accessories' on page 280 for service manual part number.

Carrying out a Two Point O₂ Calibration button the user will have to wait 6 minutes before carrying out any new operation.

The ventilator will start with a 21% calibration for 3 minutes followed by a 100% calibration for 3 minutes.

Warning: The user cannot select a ventilation mode whilst the two point calibration process is running.

If the ventilator is carrying out the standard single point 100% calibration the user will be unable to run a two point calibration until it is complete.

In a ventilation mode the O₂ measured value will read "CAL" in the O₂ parameter control until the routine is complete.

26. N5402-REV2 & N5302 flow sensor

The ventilator employs a low dead space (<1ml), heated wire anemometer sensor. To minimise dead space the sensor body fills much of the ET tube adaptor and patient circuit connection.

Warning: Do not use any nebulized gases (medications, salt solutions, etc.) in conjunction with the sensor as they are likely to degrade the performance of the sensor and subsequent displayed accuracies.

Caution: The flow sensor is a serviceable item and may require cleaning during use.

SLE offer two types of sensor the N5402-REV2 which is a reusable sensor or the N5302 which is a single use flow sensor.

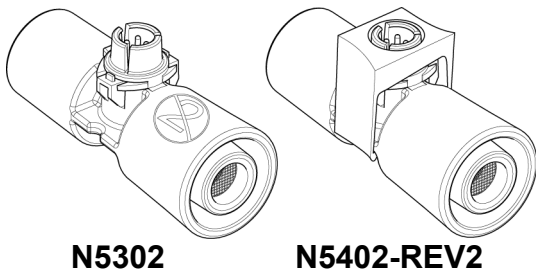

N5302

N5402-REV2

Warning: Do not use the N5302 flow sensor if its packaging has been damaged.

Warning: Do not use this flow sensor to monitor patients with ET tube sizes larger than 5.0 mm or that require more than 30 l/ min.

Note: The N5302 flow sensor is a single use device. It is supplied sterile. The sensor can be cleaned during use, but cannot be re-sterilized. It should be discarded after use as clinical waste. The N5302 flow sensor can be cleaned by rinsing into sterile water.

Before re-insertion into the patient circuit the user must calibrate the flow sensor.

26.1 Calibration of the Flow Sensor

Connect the flow sensor cable to the flow sensor. Ensure that the cable connector key fits into the rear notch of the flow sensor connector.

The ventilator will alarm calibrate flow sensor. Press the “Calibrate” button in the information bar to activate the sensor panel or press the “Utilities” button or the “Calibration and Utilities” Button.

Occlude the flow sensor to prevent any flow across the sensor wires.

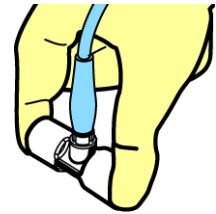

Press the Start calibration button and the following text “Calibrating..” will be displayed above the button.

When the calibrations has passed the test “Calibration completed” will appear.

The flow sensor is now calibrated.

Note: The flow sensor should be calibrated every 24 hours whilst in use, if the patient’s condition permits.

Note: The Calibration procedure is the same for the N5402-REV2 and N5302 sensors.

26.2 Cleaning and high level disinfection of the N5402-REV2 Sensor

Warning: Before each use the sensor must be checked for damage. Damaged parts must not be used.

Remove the flow sensor connecting cable before any cleaning, high level disinfection.

Rinse the sensor body immediately after use and put it into a disinfectant (recommended by the infection control authority of the hospital / organization), otherwise the sensor will encrust and cannot be used any more.

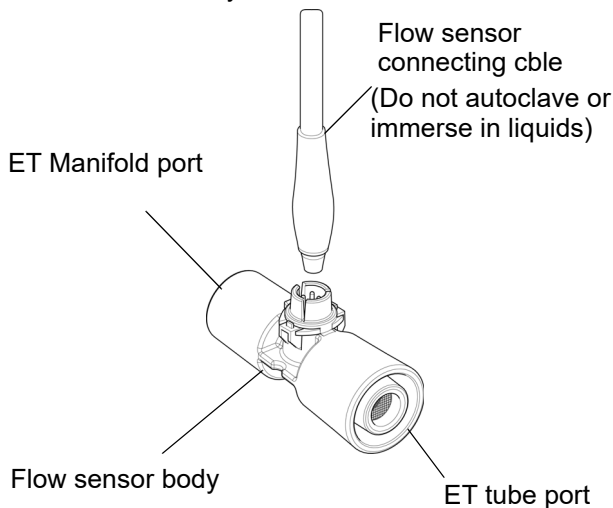

Warning: Do not clean the flow sensor with compressed air or water jet. As this will destroy the sensor wires.

Prior to first use as well as after each use clean or disinfect/high level disinfection the sensor.

26.2.1 Cleaning:

A soap solution or mild alkaline solution should be used.

26.2.2 Disinfection:

Use commercially available disinfectants that are recommended for use with PLASTIC MATERIALS. Immersion times and concentrations stated must be in accordance with manufacturer's instructions

Note: Disinfectants containing compounds similar to PHENOL or ALKYLAMINES (Glucorrotamine) are unsuitable.

Note: Eliminate all residues of cleaning agents and disinfectant used by thoroughly rinsing with sterile water after each cleaning and disinfecting procedure.

26.2.3 High level disinfection

Autoclave at

134°C (277°F) (Allowable variation of temperature of +3°C) at 220kPa (32psi) with a minimum holding time of 3 minutes.

or

121°C (248°F) (Allowable variation of temperature of +3°C) at 96kPa (14.1psi) with a minimum holding time of 15 minutes.

Note: The sensor must not be connected to other standard connectors when autoclaved to prevent cracking. Ensure no other components/items are lying on the sensor during the autoclaving process.

27. Technical specification

27.1 Operating Modes - Conventional Invasive Ventilation

This section summarises the specification of the SLE6000 ventilator in terms of the modes, ranges alarm limits on the operator adjustable controls and their accuracy. It also summarizes the mechanical and electrical power constraints.

Note: If the ventilator is set to cmH₂O via user preferences substitute cmH₂O for mbar.

27.1.1 CPAP mode

Inspiratory Time (Ti): . 0.1 to 3.0 seconds
 Resolution: 0.01 second
 Factory set default: . . 0.40 second.

CPAP Pressure - HFO pneumatics:
 0 to 35 mbar

CPAP Pressure - Conventional pneumatics:
 1 to 35 mbar

Resolution: 0.5 mbar for values <10mbar,
 1 mbar for values >10mbar

Factory set default: . . 4.0 mbar

PIP Pressure: 0 to 65 mbar
 Resolution: 1 mbar

Factory set default: . . 15 mbar

O₂ concentration: . . . 21 to 100%

Resolution: 1%

Factory set default: . . 21%

Additional Parameters:

Apnoea Backup Rate (RR Backup control):
 1 to 150 BPM

Resolution: 1 BPM

Factory set default: . . 40 BPM

Rise Time: 0.0 to 3.0 seconds

Resolution 0.01 second

Factory set default: . . 0.04 seconds

Trigger sensitivity with flow sensor

Trig Sens: 0.2 l/min to 20 l/min

Resolution: 0.2 l/min

Factory set default: . . 0.6 l/min

Trigger sensitivity without flow sensor

Trig Sens: 1% to 100%

Resolution: 1%

Factory set default: . . 50%

27.1.2 CMV mode

Respiratory Rate (RR): 1 to 150 BPM

Resolution 1 BPM

Factory set default: . . 30 BPM

Inspiratory Time (Ti): 0.1 to 3.0 seconds

Resolution: 0.01 second

Factory set default: . . 0.40 second.

PEEP Pressure - HFO pneumatics:
 0 to 35 mbar

PEEP Pressure - Conventional pneumatics
 1 to 35 mbar

Resolution 0.5 for values <10 mbar,
 1 mbar for values >10 mbar

Factory set default: . . 4.0 mbar

PIP Pressure: 0 to 65 mbar

Resolution: 1 mbar

Default: 15 mbar

VTV: 2 to 300 ml
 3 to 300 ml with etCO₂ on.

Factory set default: . . Set to "Off"

Factory set default: . . 3 ml when "On"

VTV control, when enabled becomes Vte Target control.

From 2 ml to 9.8 ml the parameter increments in 0.2 ml steps (Fine resolution)

From 10 ml to 100 ml the parameter increments in 1ml steps (Standard resolution).

From 100 ml to 300 ml the parameter increments in 5ml steps (Coarse resolution).

O₂ concentration: . . 21 to 100%

Resolution: 1%

Factory set default: . . 21%

Additional Parameters:

Rise Time: 0.0 to 3.0 seconds

Resolution: 0.01 second

Factory set default: . . 0.04 seconds

27.1.3 PTV mode

Respiratory Rate (RR): 1 to 150 BPM
 Resolution: 1 BPM
 Factory set default: . . 30 BPM

Inspiratory Time (Ti): . 0.1 to 3.0 seconds
 Resolution 0.01 second
 Factory set default: . . 0.40 second

PEEP Pressure - HFO pneumatics:
 0 to 35 mbar

PEEP Pressure - Conventional pneumatics
 1 to 35 mbar

Resolution: 0.5 mbar for values <10mbar,
 1 mbar for values >10mbar

Factory set default: . . 4.0 mbar

PIP Pressure: 0 to 65 mbar
 Resolution: 1 mbar
 Factory set default: . . 15 mbar

VTV: 2 to 300 ml
 3 to 300 ml with etCO₂ on.

Factory set default: . . Set to "Off"
 Factory set default: . . 3 ml when "On"

VTV control, when enabled becomes Vte Target control.
 From 2 ml to 9.8 ml the parameter increments in 0.2 ml steps (Fine resolution)
 From 10 ml to 100 ml the parameter increments in 1ml steps (Standard resolution).
 From 100 ml to 300 ml the parameter increments in 5ml steps (Coarse resolution).

O₂ concentration: . . . 21 to 100%
 Resolution: 1%
 Factory set default: . . 21%

Additional Parameters:
 Rise Time: 0.0 to 3.0 seconds
 Resolution: 0.01 second
 Factory set default: . . 0.04 seconds

Trigger sensitivity with flow sensor
 Trig Sens: 0.2 l/min to 20 l/min
 Resolution: 0.2 l/min
 Factory set default: . . 0.6 l/min

Trigger sensitivity without flow sensor
 Trig Sens: 1% to 100%
 Resolution: 1%
 Factory set default: . . 50%

27.1.4 PSV mode

Respiratory Rate (RR): 1 to 150 BPM
 Resolution: 1 BPM
 Factory set default: . . 30 BPM

Insp.Time (Ti Max):. . 0.1 to 3.0 seconds
 Resolution: 0.01 second
 Factory set default: . . 0.40 second

PEEP Pressure - HFO pneumatics:
 0 to 35 mbar

PEEP Pressure - Conventional pneumatics
 1 to 35 mbar

Resolution: 0.5 mbar for values <10mbar,
 1 mbar for values >10mbar

Factory set default: . . 4.0 mbar

PIP Pressure: 0 to 65 mbar
 Resolution: 1 mbar
 Factory set default: . . 15 mbar

VTV: 2 to 300 ml
 3 to 300 ml with etCO₂ on.

Factory set default: . . Set to "Off"
 Factory set default: . . 3 ml when "On"

VTV control, when enabled becomes Vte Target control.
 From 2 ml to 9.8 ml the parameter increments in 0.2 ml steps (Fine resolution)
 From 10 ml to 100 ml the parameter increments in 1ml steps (Standard resolution).
 From 100 ml to 300 ml the parameter increments in 5ml steps (Coarse resolution).

O₂ concentration: . . . 21 to 100%
 Resolution: 1%
 Factory set default: . . 21%

Additional Parameters:
 Rise Time: 0.0 to 3.0 seconds
 Resolution: 0.01 second
 Factory set default: . . 0.04 seconds

Trigger sensitivity with flow sensor
 Trig Sens: 0.2 l/min to 20 l/min
 Resolution: 0.2 l/min
 Factory set default: . . 0.6 l/min

Trigger sensitivity without flow sensor
 Trig Sens: 1% to 100%
 Resolution: 1%
 Factory set default: . . 50%

Termination Sensitivity (Term Sens control):
 (only appears when flow sensor is connected)
 5 to 50%
 Resolution 5%
 Factory set default: . . 5%

27.1.5 SIMV mode

Respiratory Rate (RR): 1 to 150 BPM
 Resolution: 1 BPM
 Factory set default: . . 30 BPM

Inspiratory Time (Ti): . 0.1 to 3.0 seconds
 Resolution 0.01 second
 Factory set default: . . 0.40 second

PEEP Pressure - HFO pneumatics:
 0 to 35 mbar
 PEEP Pressure - Conventional pneumatics
 1 to 35 mbar
 Resolution: 0.5 mbar for values <10mbar,
 1 mbar for values >10mbar
 Factory set default: . . 4.0 mbar

PIP Pressure: 0 to 65 mbar
 Resolution: 1 mbar
 Factory set default: . . 15 mbar

VTV: 2 to 300 ml
 3 to 300 ml with etCO2 on
 Factory set default: . . Set to "Off"
 Factory set default: . . 3 ml when "On"

VTV control, when enabled becomes Vte Target control.

From 2 ml to 9.8 ml the parameter increments in 0.2 ml steps (Fine resolution)

From 10 ml to 100 ml the parameter increments in 1ml steps (Standard resolution).

From 100 ml to 300 ml the parameter increments in 5ml steps (Coarse resolution).

O₂ concentration: . . . 21 to 100%
 Resolution: 1%
 Factory set default: . . 21%

Additional Parameters:

Rise Time: 0.0 to 3.0 seconds
 Resolution: 0.01 second
 Factory set default: . . 0.04 second

P Support: 0 to 65 mbar
 Factory set default: . . Set to "Off"
 Factory set default: . . 8 mbar when "On"

Trigger sensitivity with flow sensor
 Trig Sens: 0.2 l/min to 20 l/min
 Resolution: 0.2 l/min
 Factory set default: . . 0.6 l/min
Trigger sensitivity without flow sensor
 Trig Sens: 1% to 100%
 Resolution: 1%
 Factory set default: . . 50%

Termination Sensitivity (Term Sens control):
 5 to 50%
 Resolution 5%
 Factory set default: . . 5%

Note: Termination Sensitivity parameter is not shown when pressure support (P Support) is off.

27.1.6 HFOV mode

Frequency: 3 to 20 Hz
 Resolution: 0.1 Hz
 Factory set default: . . 10.0 Hz

I: E Ratio: 1:1 / 1:2 / 1:3
 Factory set default: . . 1:1

MAP: 0 to 45 mbar
 Resolution: 1 mbar
 Factory set default: . . 5 mbar

Delta P Range: 4 to 180 mbar
 Resolution: 1 mbar
 Factory set default: . . 4 mbar

O₂ concentration: . . . 21 to 100%
 Resolution: 1%
 Factory set default: . . 21%

Additional Parameters:

Sigh RR: 1 to 150 BPM
 Resolution: 1 BPM
 Factory set default: . . Set to "Off"
 Factory set default: . . 30 BPM when "On"

Sigh Ti control: 0.1 to 3.0 seconds
 Resolution: 0.01 second
 Factory set default: . . 0.40 second

Sigh P control: 0 to 45 mbar
 Resolution: 1 mbar
 Factory set default: . . 10 mbar

VTV: 2 to 50 ml
 Factory set default: . . Set to "Off"
 Factory set default: . . Last Vte value when "On"

VTV control, when enabled becomes Vte Target control.

From 2 ml to 9.8 ml the parameter increments in 0.2 ml steps (Fine resolution)

From 10 ml to 50 ml the parameter increments in 1ml steps (Standard resolution).

27.1.7 HFOV+CMV mode

Respiratory Rate (RR): 1 to 150 BPM
 Resolution: 1 BPM
 Factory set default: . . 30 BPM

Inspiratory Time (Ti):. 0.1 to 3.0 seconds
 Resolution: 0.01 second
 Factory set default: . . 0.40 second

Frequency Range: . . 3 to 20Hz
 Resolution: 0.1Hz
 Factory set default: . . 10.0 Hz.

PEEP Pressure: 0 to 35 mbar
 Resolution: 0.5 mbar <10 mbar,
 1 mbar >10 mbar
 Factory set default: . . 4.0 mbar

PIP Pressure: 0 to 65 mbar
 Resolution: 1 mbar
 Factory set default: . . 15 mbar

Delta P Range: 4 to 180 mbar
 Resolution: 1 mbar
 Factory set default: . . 4 mbar

O₂ concentration: . . 21 to 100%
 Resolution: 1%
 Factory set default: . . 21%

Additional Parameters:

HFO Activity:. Oscillation on both high and low cycles.
 Oscillation on low cycle only.

Oscillation Pause: . . . 60 seconds

27.2 Operating Modes Conventional Non Invasive Ventilation

27.2.1 nCPAP D mode (Dual Limb)

Inspiratory Time (Ti): . 0.1 to 3.0 seconds

Resolution: 0.01 second

Factory set default: . . 0.40 second

CPAP Pressure - HFO pneumatics:
0 to 35 mbar

CPAP Pressure - Conventional pneumatics:
1 to 35 mbar

Resolution: 0.5 mbar for values <10mbar,
1 mbar for values >10mbar

Factory set default: . . 4 mbar

PIP Pressure: 0 to 65 mbar

Resolution: 1mbar

Factory set default: . . 15mbar

O₂ concentration: . . . 21 to 100%

Resolution: 1%

Factory set default: . . 21%

Additional Parameters:

RR Backup control: . . 1 to 150 BPM

Resolution: 1 BPM

Factory set default: . . Set to "Off"

Factory set default: . . 40 BPM when "On"

Rise Time: 0.0 to 3.0 seconds

Resolution: 0.01 second

Factory set default: . . 0.04 second

Trig Sens: 1% to 100%

Resolution: 1%

Factory set default: . . 50%

27.2.2 NIPPV D mode (Dual Limb)

Respiratory Rate (RR): 1 to 150 BPM

Resolution: 1 BPM

Factory set default: . . 30 BPM

Inspiratory Time (Ti):. 0.1 to 3.0 seconds

Resolution: 0.01 second

Factory set default: . . 0.40 second

PEEP Pressure - HFO pneumatics:
0 to 35 mbar

PEEP Pressure - Conventional pneumatics
1 to 35 mbar

Resolution: 0.5 mbar for values <10mbar,
1 mbar for values >10mbar

Factory set default: . . 4 mbar

PIP Pressure: 0 to 65 mbar

Resolution: 1 mbar)

Factory set default: . . 15 mbar

O₂ concentration: . . 21 to 100%

Resolution: 1%

Factory set default: . . 21%

Additional Parameters:

Rise Time: 0.0 to 3.0 seconds

Resolution: 0.01 second

Factory set default: . . 0.04 second

27.2.3 NIPPV Tr. mode (Dual Limb)

Respiratory Rate (RR): 1 to 150 BPM

Resolution: 1 BPM

Factory set default: . . 30 BPM

Inspiratory Time (Ti):. 0.1 to 3.0 seconds

Resolution: 0.01 second

Factory set default: . . 0.40 second

PEEP Pressure - HFO pneumatics:
0 to 35 mbar

PEEP Pressure - Conventional pneumatics
1 to 35 mbar

Resolution: 0.5 mbar for values <10mbar,
1 mbar for values >10mbar

Factory set default: . . 4 mbar

PIP Pressure: 0 to 65 mbar

Resolution: 1 mbar

Factory set default: . . 15 mbar

O₂ concentration: . . 21 to 100%

Resolution: 1%

Factory set default: . . 21%

Additional Parameters:

Rise Time: 0.0 to 3.0 seconds
 Resolution: 0.01 second
 Factory set default: . . 0.04 second

Trig Sens: 1% to 100%
 Resolution: 1%
 Factory set default: . . 50%

27.2.4 nHFOV mode (Dual Limb)

Frequency: 3 to 20Hz
 Resolution: 0.1Hz
 Factory set default: . . 10.0 Hz

I: E Ratio: 1:1 / 1:2 / 1:3
 Factory set default: . . 1:1

Mean airway pressure (MAP control):
 0 to 45 mbar
 Resolution: 1 mbar
 Factory set default: . . 5 mbar

Delta P Range: 4 to 180 mbar
 Resolution: 1 mbar
 Factory set default: . . 4 mbar

O₂ concentration: . . . 21 to 100%
 Resolution: 1%
 Factory set default: . . 21%

Additional Parameters:

Sigh RR: 1 to 150 BPM
 Resolution: 1 BPM
 Factory set default: . . Set to "Off"
 Factory set default: . . 30 BPM when "On"

Sigh Ti control: 0.1 to 3.0 seconds
 Resolution: 0.01 second)
 Factory set default: . . 0.40 second

Sigh P control: 0 to 45 mbar
 Resolution: 1 mbar
 Factory set default: . . 10 mbar

27.2.5 nCPAP S mode (Single Limb)

Inspiratory Time (Ti):. 0.1 to 3.0 seconds
 Resolution: 0.01 second
 Factory set default: . . 0.50 second

CPAP Pressure: 2 to 15 mbar
 Resolution: 0.5 mbar for values <10mbar,
 1 mbar for values >10mbar
 Factory set default: . . 4.0 mbar

PIP Pressure: 2 to 25 mbar
 Resolution: 1mbar
 Factory set default: . . 10mbar

O₂ concentration: . . 21 to 100%
 Resolution: 1%
 Factory set default: . . 21%

Additional Parameters:

RR Backup control: . . 1 to 10 BPM
 Resolution: 1 BPM
 Factory set default: . . Set to "Off"
 Factory set default: . . 10 BPM when "On"

Trig Sens: 1% to 100%
 Resolution: 1%
 Factory set default: . . 50%

27.2.6 DuoPAP mode (Single Limb)

Respiratory Rate (RR): 1 to 60 BPM
 Resolution: 1 BPM
 Factory set default: . . 20 BPM

Inspiratory Time (Ti):. 0.1 to 3.0 seconds
 Resolution: 0.01 second
 Factory set default: . . 0.50 second

PEEP Pressure: 2 to 15 mbar
 Resolution: 0.5 mbar for values <10mbar,
 1 mbar for values >10mbar
 Factory set default: . . 4.0 mbar

PIP Pressure: 2 to 25 mbar
 Resolution: 1mbar
 Factory set default: . . 10mbar

O₂ concentration: . . 21 to 100%
 Resolution: 1%
 Factory set default: . . 21%

27.2.7 O2 therapy (Single Limb)

Flow Rate: 2 to 30 l/min

Resolution: 0.1 l/min

Factory set default: . . 8.0 l/min.

O₂ concentration: . . . 21 to 100%

Resolution: 1%

Factory set default: . . 21%

27.2.8 OxyGenie

O₂ range: 21 to 100%

Target ranges: 90-94, 91-95, 92-96, 94-98

27.2.8.1 OxyGenie PCLCS attributes

For normal use case

Response time 19 seconds

Settling time 29 seconds

Overshoot 4%

For worst use case

Response time 20 seconds

Settling time 38 seconds

Overshoot 4%

27.3 Mode of operation

The ventilator is designed for continuous operation.

27.4 Controls

27.4.1 Power Button

The ON/OFF button has an integrated LED to indicate status of the ventilator, where:

“LED Off” means the unit is off and no mains power is connected to the system,

“Green” colour means unit is on and ready to use,

“Amber” colour means the ventilator is off, mains power is connected and the internal batteries are fully charged,

“Flashing Amber” colour means the ventilator is off, the mains power is connected and the internal batteries are charging;

27.4.2 User Interface





The SLE6000 is fitted with a colour display with a screen resolution of 1024 by 768 pixels.





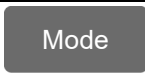

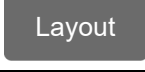
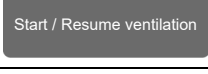
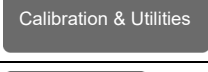
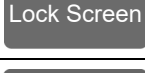



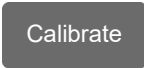







The screen size is 12.1” with an LED backlight.





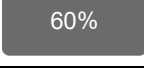
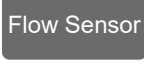

The touch screen is suitable for operation whilst wearing medical gloves.



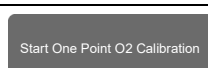

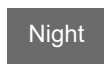
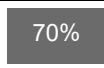
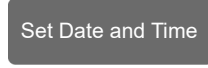

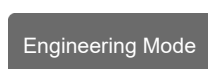
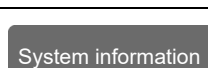
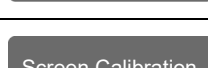
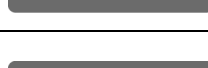
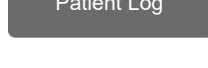
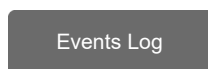
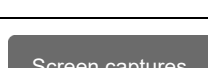
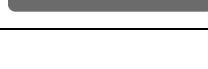



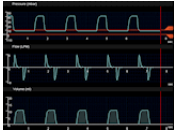

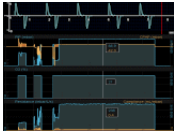





27.4.2.1 Buttons



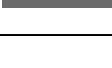





The following buttons are accessible via the touch screen.



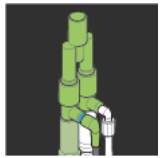

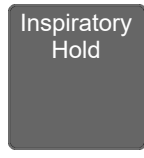
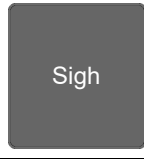
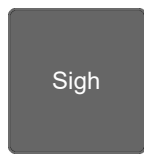
Button	Description
	Opens the mode tabs Single press to select or cancel
	Open the alarm tabs Single press to select or cancel
	Opens the utilities tabs Single press to select or cancel
	Opens the layout tabs Single press to select or cancel
	Opens the mode tabs Single press to select
	Opens the utilities tabs Single press to select
	Locks the screen Single press to select
	Unlock the screen Touch and hold for 1 second
	Reset the active alarm or clears an alarm message Single press to select

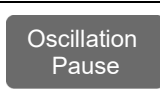
Button	Description
	Selects sensors tab Single press to select
	Selects CPAP mode Single press to select or cancel
	Selects CMV mode Single press to select or cancel
	Selects PTV mode Single press to select or cancel
	Selects PSV mode Single press to select or cancel
	Selects SIMV mode Single press to select or cancel
	Selects HFOV mode Single press to select or cancel
	Selects HFOV+CMV mode Single press to select or cancel
	Selects NCPAP mode Dual or Single limb Single press to select or cancel
	Selects NIPPV mode Dual limb Single press to select or cancel
	Selects NHFOV mode Dual limb only Single press to select or cancel
	Selects O2 therapy mode Single limb only Single press to select or cancel
	Selects Standby mode Single press to select or cancel
	Rapid scroll up Single press to select
	Slow scroll up Single press to select
	Slow scroll down Single press to select
	Rapid scroll down Single press to select
	Loudness % Single press to select or cancel
	Selects the flow sensor calibration Single press to select
	Starts the calibration routine Single press to select

Button	Description
	Selects the Oxygen calibration Single press to select
	Starts the calibration routine Single press to select
	Selects the day screen mode Single press to select
	Selects the night screen mode Single press to select
	Selects the brightness % Single press to select
	Selects the date/time buttons Single press to select
	Selects the code panel for user preference setup mode Single press to select
	Selects the code panel for engineering mode Single press to select
	Displays the system information Single press to select
	Selects the code panel for screen calibration mode Single press to select
	Activates Patient log export utility Requires USB memory stick to be inserted. Single press to select
	Activates Events log export utility Requires USB memory stick to be inserted. Single press to select
	Activates Screen captures export utility Single press to select
	Starts the selected data export. Single press to select - only active when USB memory stick present and in standby mode.
	Cancels the selected data export. Single press to select - only active when USB memory stick present, in standby mode and export in progress.
	Returns user to Data tab. Single press to select - only active when USB memory stick present, in standby mode and export complete. Times out after 3 seconds

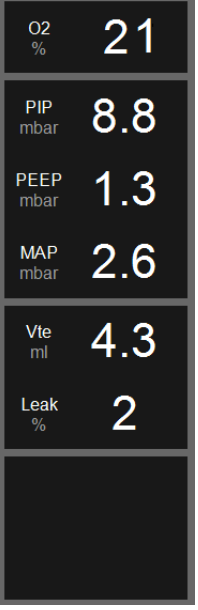

Button	Description
	Selects the waveforms layout Single press to select
	Selects the loops layout Single press to select
	Selects the trends layout Single press to select
	Opens the selected layout tab Single press to select
	Toggles between On & Off Single press to select or cancel
	Selects the pressure waveform Single press to select
	Selects the flow waveform Single press to select
	Selects the volume waveform Single press to select
	Selects the flow/volume loop Single press to select
	Selects the flow/pressure loop Single press to select
	Selects the volume/pressure loop Single press to select
	Selects the trend drop down menu Single press to select
	Confirm setting button Single press to select
	Cancel/Exit button Single press to select
	Activates the trend zoom function Single press to select or cancel
	Activates the trend cursor Single press to select or cancel
	Activates the trend scroll function Single press to select or cancel
	Increase setting Single press to select

Button	Description
	Decrease setting Single press to select
	Selects 10 mm patient circuit ventilation Single press to select
	Selects 15 mm patient circuit ventilation Single press to select
	Activates all additional parameters Single press to select or cancel
	Activates a manual breath Single press to select
	Activates an inspiratory hold Single press to select or button can be held for a a maximum of 5 or 10 seconds depending on user set preference.
	Activates an oscillatory sigh Single press to select
	Activates an oscillatory sigh hold Single press to select or button can be held for a a maximum of 5 or 10 seconds depending on user set preference.
	Activates OxyGenie Single press to select..
	Activates an oscillatory pause. Press and hold for 2 seconds
	Pauses the waveforms Single press to select Press and hold for 1 second to activate screen capture.
	Releases the paused waveforms Single press to select Press and hold for 1 second to activate screen capture.

Button	Description
	Save screen capture to memory Press and hold for 3 seconds to activate screen capture
	Number keys 0 to 9 Single press to select
	Backspace - Cancels input Single press to select
	Back button - returns to previous tabs Single press to select
	Alarm audio pause Single press to select or cancel
	Measured values Press and hold for 1 second to toggle between single and double column values.

27.4.2.2 Tabs

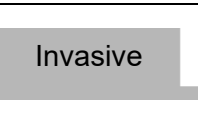
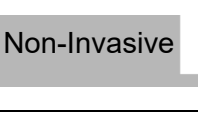

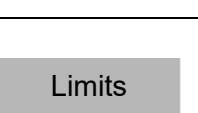

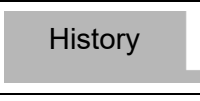
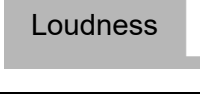
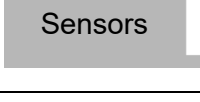
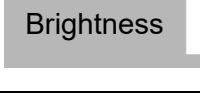
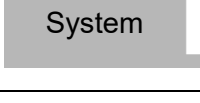
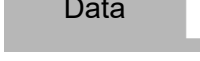
The following Tabs are available via the touch screen:

Tabs	Description
	Invasive mode tab Tab allows access to Invasive modes and circuit size selection. Single press to select
	Non-Invasive mode tab Tab allows access to Non-invasive modes. Single press to select
	Standby mode tab Tab allows access to Standby mode. Standby mode only active when ventilating. Single press to select
	Limits tab Tab allows access to alarm limits. Alarm limits only active when ventilating. Single press to select

Tabs	Description
	History tab Tab allows access to alarm history. Single press to select
	Loudness tab Tab allows access to alarm loudness adjustment tab. Single press to select
	Sensors tab Tab allows access to sensor calibration tab. Single press to select
	Brightness tab Tab allows access to screen brightness adjustment tab. Single press to select
	System tab Tab allows access to system functions tab. Single press to select
	Data tab Tab allows access to data tab. Single press to select

27.4.2.3 Controls

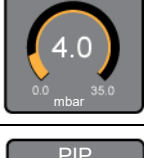
The following Controls are available via the touch screen:

Controls	Description
	Ti (Inspiratory time) control Range 0.1 - 3.0 seconds Single press to select or cancel
	Ti Max (Maximum inspiratory time) control Range 0.1 - 3.0 seconds Single press to select or cancel
	CPAP control Range 0.0 - 35 mbar Single press to select or cancel
	PEEP control Range 0.0 - 35 mbar Single press to select or cancel
	PIP control Range 1 - 65 mbar Single press to select or cancel

Technical data

Controls	Description
	Oxygen % control Range 21 - 100 % Single press to select or cancel
	RR Backup (Respiratory rate) control Range 1 - 150 BPM Single press to select or cancel
	Rise time control Range 1 - 150 BPM Single press to select or cancel
	Trig Sens (Trigger sensitivity) control Range 1 - 150 l/min With flow sensor Range 1 - 100 % Without flow sensor Single press to select or cancel
	RR (Respiratory rate) control Range 1 - 150 BPM Single press to select or cancel
	Term Sens (Termination sensitivity) control Range 5 - 50 % Single press to select or cancel
	VTV (Volume targeted ventilation) control Vte Target when on. Range 2 - 300 ml Press and hold for 2 seconds to select
	P Support control Range 0 - 65 mbar Press and hold for 2 seconds to select
	ΔP (Delta pressure) control Range 4 - 180 mbar Single press to select or cancel
	MAP control Range 0 - 45 mbar Single press to select or cancel

Controls	Description
	Frequency control Range 3 - 20 Hz Single press to select or cancel
	I:E (Inspiratory to expiratory ratio) control Range 3 - 20 Hz Single press to select or cancel
	Sigh RR (Sigh respiratory rate) control Range 1 - 150 BPM Press and hold for 2 seconds to select
	Sigh Ti (Sigh inspiratory time) control Range 0.1 - 3.0 seconds Single press to select or cancel
	Sigh P (Sigh pressure) control Range 0 - 45 mbar Single press to select or cancel

27.5 Measurement

27.5.1 Flow sensor

Flow Sensor Type: . . . 10 mm dual-hot-wire anemometer.

Flow Rate: 0.2 l/min to 30 l/min

Accuracy: $\pm 8\%$ maximum

27.5.2 Volume controlled breath accuracy

Volume

Maximum Bias error: . . . $\pm 3\text{ ml}$

Maximum linearity error: $\pm 8\%$

PEEP

Maximum Bias error: . . . $\pm 1\text{ mbar}$

Maximum linearity error: $\pm 18\%$

Oxygen

Maximum Bias error: . . . $\pm 3\%$

Maximum linearity error: $\pm 0.5\%$

27.5.3 Pressure controlled breath accuracy (Invasive Ventilation)

PIP

Maximum Bias error: . . . $\pm 1\text{ mbar}$

Maximum linearity error: $\pm 11\%$

PEEP

Maximum Bias error: . . . $\pm 1\text{ mbar}$

Maximum linearity error: $\pm 18\%$

Oxygen

Maximum Bias error: . . . $\pm 3\%$

Maximum linearity error: $\pm 0.5\%$

27.5.4 Pressure controlled breath accuracy (Non-invasive Ventilation)

PIP

Maximum Bias error: . . . $\pm 1\text{ mbar}$

Maximum linearity error: $\pm 18\%$

PEEP

Maximum Bias error: . . . $\pm 1\text{ mbar}$

Maximum linearity error: $\pm 18\%$

Oxygen

Maximum Bias error: . . . $\pm 3\%$

Maximum linearity error: $\pm 0.5\%$

27.5.5 Measured parameters

Leak

Resolution: 1%

Percentage leak measured around ET tube (when using an un-cuffed tube). The difference between the expired volume compared to the inspired volume as a percentage and averaged over 5 breaths. A calculated value.

Value smoothed with a filter (time constant equal to 10 breaths).

Respiratory Rate (RR)

Resolution: 1 BPM

Total number of breaths detected by the ventilator. (Mechanical and patient triggered). A measured value.

Compliance (C)

Resolution: 1ml/mbar

Compliance is the ratio of the change in lung volume to change in the applied pressures. A calculated value. Value smoothed with a filter (time constant equal to 3 breaths).

C20/C:

Resolution 0.1

Sampling Time: 2ms

Is the ratio of the compliance during the last 20% of the respiratory cycle to the total compliance. A calculated value. Value smoothed with a filter (time constant equal to 3 breaths).

Resistance (R)

Resolution 1

Resistance of the patient lung to flow The total change in the applied pressure to the patient lung divided by the peak expiratory flow from the lung. A measured value.

Value smoothed with a filter (time constant equal to 3 breaths).

Inspiratory time (Ti).

Resolution: 10 milliseconds

The measured inspiratory time, where the breath may be flow or volume terminated and therefore shorter than the set inspiratory time.

Expiratory time (Te)

Resolution: 10 milliseconds

The measured expiratory time, Total respiratory rate minus the Inspiratory time. A calculated value.

Vmin (l)

Resolution: 0.01 l

Minute volume is the accumulated expiratory tidal volume over a one-minute period. A measured value in litres per minute.

Trigger (Trig)

Resolution: 1

The number of patient triggered breaths (updated every 2 seconds). A measured value.

Vte (ml)

Resolution: 0.1 ml

Expired volume of large and small breaths. A measured value in millilitres. Value smoothed with a filter (time constant equal to 3 breaths).

DCO₂

Resolution 1

Is a gas transport coefficient. A calculated value based on tidal volume and frequency. Value smoothed with a filter (time constant equal to 3 breaths).

I:E Ratio

Resolution 0.1

Inspiratory to Expiratory ratio. A calculated value derived from the user set inspiratory time against the time divided by the user set BPM minus the inspiratory time.

etCO₂

mmHg

Resolution: 0.1 mmHg

Kpa

Measurement range: . 0 to 9.9 kPa

Resolution: 0.1 kPa

End-tidal CO₂. A measured value.

% volume

Measurement range: . 0 to 100 %

Resolution: 1 %

SpO₂

Resolution: 1 %

Peripheral capillary oxygen saturation. A measured value.

PR (Pulse rate)

Resolution: 1 Pulse

A measured value.

PI (Perfusion index)

Resolution: 0.1

A calculated value.

27.5.5.1 Oxygen Concentration

Resolution: 1%

Accuracy: ±3%

Response time: 45 seconds

27.5.5.2 Pressure

Resolution: 0.1 mbar

Accuracy: ±0.75% of full scale

A measured value

Resolution: 0.1 mbar

Accuracy: ±0.75% of full scale

A measured value

Resolution: 0.1 mbar

Accuracy: ±0.75% of full scale

A measured value

Delta P:

Resolution: 1 mbar

In HFO combined mode Delta P is measured during expiration only. A measured value.

Above values are obtained under ATPD (ambient temperature and pressure, dry) conditions.

27.5.5.3 Trends

Trend data logged at 1 Hz

27.5.5.4 Sound pressure level

Sound pressure level: 49 dBA

Sound power level: . . 53 dBA

27.5.5.5 Exhalation Block Port Jet Sizes

Reverse or negative jet:

Ø 1.45/1.5 mm

Forward or positive jet:

Ø 1.25/1.3 mm

Mean or 3rd jet: Ø 0.60/1.0 mm

27.5.6 BS EN ISO 80601-2-12 Disclosure

Volume controlled breaths

As per the above standard, Clause 201.12.1.101 Volume-controlled breath type, maximum inaccuracies are contained within the tolerances

stated in Section 27.5.2 of this document.

With reference to Note 3 of Clause 201.12.1.101

Intentionally, for some of these tests, i.e., those with a large compliance and a large resistance, the end expiratory flow will not reach zero.

In these cases the actual delivered volume and the value in table 201.103 (within BS EN ISO 80601-1-12) the following differences are recorded:

Volumes of 50 ml and the O₂% set to 60% (Circuit compliance 3 ml/hPa, resistance 200 hPa/l/s, BPM 30 and Ti of 0.6 sec.) inaccuracy rises to ±12%.

PEEP at volumes of 20 ml and the O₂% set to 30% (Circuit compliance 1 ml/hPa, resistance 200 hPa/l/s, BPM 60 and Ti of 0.4 sec.) inaccuracy rises to ±38%.

Pressure controlled breaths

As per the above standard, Clause 201.12.1.102 Volume-controlled breath type, maximum inaccuracies are contained within the tolerances stated in Section 27.5.3 of this document.

With reference to Note 3 of Clause 201.12.1.102

Intentionally, for some of these tests, i.e., those with a large compliance and a large resistance, the end expiratory flow will not reach zero.

In these cases the actual delivered volume and the value in table 201.104 (within BS EN ISO 80601-1-12) the following differences are recorded:

PIP at 15 mbar and the O₂% set to 30% (Circuit compliance 20 ml/hPa, resistance 20 hPa/l/s, BPM 20 and Ti of 1 sec.) inaccuracy rises to ±11%.

PEEP at 5 mbar and the O₂% set to 30% (Circuit compliance 3 ml/hPa, resistance 50 hPa/l/s, BPM 30 and Ti of 0.6 sec.) inaccuracy rises to ±34%.

27.5.7 Measurement uncertainties

Below are listed the measurement uncertainties for following monitored variables:

Flow ±2%
 Pressure ±0.5%
 Oxygen concentration ±2%

27.6 Patient circuits

Ø 10 mm BC6188

Resistance: @15 l/min 1.5 mbar
 Resistance: @30 l/min 6 mbar
 Compliance: 1.89 ml/kPa/m
 Inspiratory and expiratory pressure drop
 5 l/min 0.8 mbar
 2.5 l/min 0.38 mbar

Ø 10 mm BC6188/DHW

Resistance: @15 l/min 1.5 mbar
 Resistance: @30 l/min 6 mbar
 Compliance: 1.89 ml/kPa/m
 Inspiratory and expiratory pressure drop
 5 l/min 1.50 mbar
 2.5 l/min 0.25 mbar

Ø 15 mm BC6198

Resistance: @15 l/min 0.3 mbar
 Resistance: @30 l/min 1.0 mbar
 Compliance: 3.72 ml/kPa/m
 Inspiratory and expiratory pressure drop
 5 l/min 0.15 mbar
 2.5 l/min 0 mbar

27.7 Breathing system filters

27.7.1 N3029

Filtration Efficiency: . BFE 99.999% VFE 99.992%
 Resistance
 @ 30 l/min: 160 pa
 Dead space: 65ml
 Connections: 22M/15F-22F/15M
 Weight: 40gm
 Autocalve cycles: . . . 5

27.7.2 N3587

Filtration Efficiency: . BFE 99.99% VFE 99.99%
 Resistance
 @ 30 l/min: 49.5pa
 Dead space: 30 ml
 Connections: 22M/15F-22F
 Weight: 23gm

27.12 Operating Environment

Temperature: +10°C to +40°C
Relative Humidity: . . 10 to 90% (Non condensing)
Ambient pressure: . . 620 mbar (4000m) to 1060
mbar (Sea level)
Size, Ventilator only: . 330 mm W x 369 mm H x 548
mm D
Height on pole: 1310 mm
Weight (ventilator): . . 22Kg

Note: The ventilator maintains the accuracy of controlled and displayed variables when operating within the above stated limits of temperature, humidity and ambient pressure.

27.12.1 Connectors

Exhalation port: 15 mm (F) /22 mm (M)
Conical to ISO5356-1
Proximal Airway: 5 mm Non Conical
Fresh Gas Port: 15 mm (M)
Conical to ISO5356-1
Nebuliser port: 5 mm Non Conical

27.13 Classification (Electrical)

Type of protection against electric shock: Class I.
Degree of protection against electric shock: Type
BF applied part.
Unit must be earthed.

27.14 GMDN classification number

GMDN: 14361

27.15 IP rating

Type of protection against ingress of water: IP21
First digit 2: Protected against solid foreign objects
of 12,5 mm in diameter and greater
Second digit 1: Protection against vertically falling
water drops.

27.16 Environmental Storage Conditions

When packed for transport or storage;
Ambient Temperature:
-20°C to +50°C
Relative Humidity: . . . 10% to 90% non-condensing
Atmospheric Pressure:
500 mbar to 1060 mbar

28. Output ports (Electrical)

28.1 RS232 port

The SLE6000 has two versions of data output

Basic data output (V2.0) listed below or Enhanced data output (V3.0)

See “SLE6000 enhanced data output (V3.0)” on page 176. for description.

28.2 SLE6000 basic data output (V2.0).

The SLE6000 basic data output is the default protocol used to output data from the ventilator to an external medical monitor.

The data is a comma delimited ASCII string of 63 device parameters.

28.2.1 SLE6000 basic data output specifications (V2.0)

SLE6000 basic data output contains a Header, Data and Footer format.

Header	Data	Footer
Device ID, Version, Pressure Units, Number of Parameters	63 Parameters, Comma separated	CRC, Carriage Return, Line Feed

The data is output at a fixed baud rate, with no parity bits or hardware handshaking in use. The protocol is a unidirectional protocol and does not require a response from the connected medical monitor. The protocol does not allow for transmission of data by the medical display monitor; any data received by the SLE6000 ventilator will be ignored.

28.2.2 Communications Settings (V2.0)

The SLE Protocol is transmitted using an RS232 format, with a fixed baud rate. The communication interface uses the following RS232 settings:

Setting Type	Value
Baud Rate	19,200 bps
Parity	None
Data Bits	8
Stop Bits	1
Data Format	ASCII Text String
Flow Control	None

28.2.2.1 Data Rate & Size (V2.0)

The transmission of the data string begins every 1 second. The maximum size of each ASCII string is 512 bytes.

28.2.2.2 Data Format

Data within the SLE6000 basic data output is implemented as a comma delimited ASCII string format. All valid data is represented using alphanumeric characters. Characters are used to represent data which is out of range or invalid for a different reason and will be used in place of the parameter value.

Character(s)	Use case	Description
'?'	Invalid data	Data which is unknown or has timed out will be replaced by '?'.
'-'	Data is out of range	Each data has an associated range. Data which is out of this range is replaced by '-'
','	Separation of parameters	
<CR><LF>	End of output string	Carriage return, Line Feed. Used to indicate the end of a data transmission

28.2.3 Data Layout

An example of the output is shown below. The header and footer sections are shown in bold the data is in italics.

Header	Data
SLE6000,V2.0,0,63,30,-,15,40,15,21,4,-,?, ?, ?, ?, 1, 0, ?, ?, 4, ?, ?, 35, ?, 10, 90, 110, 200, 0, 300, 0, 18000, 20, 50, 88, 99, 100, 180, 0, 0, 40, 0, 0, 0, 0, 20, 0, 0, 0, -, -, -, -, -, ?, ?, ?, ?, ?, -, -, -, -, 64, 6968	
	Footer

Header Format

Parameter Name	Description	Value
Ventilator ID	Unique to each type of ventilator. i.e. "SLE6000"	SLE6000
Version ID	Protocol Version ID	V2.0
Pressure Units	The units of all displayed pressure values. mbar or cmH ₂ O	'0' - mbar, '1' - cmH ₂ O
Parameter Number	The number of parameters output.	63

Footer Format

Description	Number of Characters	Range
CRC Value	4	0000 – FFFF
Carriage Return	1	<CR> (0x0D)
Line Feed	1	<LF> (0x0A)

28.2.4 Data Format

The data contains 63 parameters which are outputted in a fixed order. Each parameter has a defined limit and scaling. Each parameter is output in integer format.

The validity of each parameter is checked before transmission by the SLE6000 ventilator.

Note: If the Pressure Units parameter is unknown, then all pressure related parameters are replaced by the invalid data character.

N°	Name	Description	Units	Output Range (Physical range)
1	RR	Set Respiratory Rate (Breaths per minute).	Breaths/min	1 – 150 0 if RR backup is OFF
2	CPAP	Set CPAP value.	0.1 * pressure units	0 – 350 (0 – 35 mbar or cmH ₂ O)
3	Tidal Volume	Set Target Tidal Volume	0.2ml	10 – 1500 (2 – 300ml) 15 – 1500 (3 – 300ml) with etCO ₂ sensor connected
4	Ti	Set Target inspiratory time	0.01s	10 – 300 (0.10 – 3.00s)
5	PIP	Set PIP Pressure	Pressure Unit (1 mbar or 1 cmH ₂ O)	0 – 65 (mbar or cmH ₂ O) 2 – 25 (mbar or cmH ₂ O) in nCPAP S, DuoPAP Sigh P value in HFOV, nHFOV
6	O2	Set Oxygen Concentration	%	21 – 100
7	HFO Delta P	Set HFO Delta P	Pressure Unit	4 – 180 (mbar or cmH ₂ O)
8	HFO MAP	Set HFO Mean Pressure	Pressure Unit	0 – 45 (mbar or cmH ₂ O)
9	HFO Frequency	Set HFO Rate	0.1Hz	30 – 200 (3.0 – 20.0Hz)
10	Sigh RR	Backup Respiratory rate in HFO mode	Breaths/min	0 – 150 '-' if sigh cycling is not enabled.
11	Sigh Ti	Inspiratory time in HFO mode, for Sigh breaths	0.01s	10 – 300 (0.10 – 3.00s) '-' if sigh cycling is not enabled.
12	Sigh P	Pressure applied in Sigh breaths, HFO mode.	Pressure unit	0 – 45 (mbar or cmH ₂ O) '-' if sigh cycling is not enabled.
13	Ventilation Mode	n/a	n/a	Uses the Breath mode enumerated list: CPAP = 0 CMV = 1 PTV = 2 PSV = 7 SIMV = 3 HFO only = 4 HFO + CMV = 5 nCPAP D= 9 NIPPV (Dual limb)= 10 NIPPV Tr = 11 NHFOV (Dual limb)= 12 NCPAP (Single limb)=13 DuoPAP =14 O2 Therapy = 16 Standby = 17
14	VTV Status	N/A	N/A	0 = OFF. 255 = ON.
15	Termination Sensitivity	Set % of breath maximum flow which triggers breath termination.	%	5 – 50 '-' when OFF
16	Breath Trigger Threshold	Target trigger threshold	0.1Lpm for low triggering. If Pressure triggered then 0.5%	2 – 200 (0.2 – 20 l/min for flow triggering. 1 – 100% for Pressure Triggering)

Technical data

N°	Name	Description	Units	Output Range (Physical range)
17	Rise Time	Time taken for pressure curve to reach 99% of the target pressure	10ms	0 – 300 (0.00 – 3.00s)
18	Set Flow (O2 Mode)	Expiratory port flow whilst in O2 support mode.	0.1 l/min	50 – 300 (5.0 – 30.0l/min)
19	Nebuliser Enabled	Nebuliser is connected and enabled.	ON/OFF	255 = ENABLED 0 = DISABLED
20	Patient Leak alarm	Leak alarm value	%	5 – 50 '-' when OFF
21	Apnoea Alarm	Time taken to trigger the apnoea alarm	Seconds	5 – 60 '-' when Apnoea alarm is turned off
22	Low pressure alarm	Value to trigger a low pressure alarm	0.1 * Pressure Unit	-2200 – 1100 (-220 – 110 mbar or cmH ₂ O)
23	High PEEP Alarm	High PEEP alarm threshold.	0.1*Pressure Unit	0 – 450 (0 – 45.0 mbar) 1 – 450 (1 – 45.0 cmH ₂ O)
24	Cycle Fail alarm	Cycle Fail alarm threshold.	0.1 * Pressure Unit	0 – 640 (0 – 64 mbar or cmH ₂ O)
25	High PIP Alarm High Paw alarm in HFOV, HFOV+ CMV and nHFOV	Value to trigger a high pressure alarm	0.1 * Pressure Unit	10 – 1750 (1 – 175 mbar) 50 – 1750 (5 – 175 cmH ₂ O)
26	Low tidal volume alarm	Value to trigger a low tidal volume alarm	0.1ml	0 – 3950 (0 – 395ml)
27	High tidal volume alarm	Value to trigger a high tidal volume alarm	0.1ml	10 – 4000 (1 – 400ml)
28	Low minute volume alarm	Value to trigger the minute volume alarm (low)	ml	0 – 17900 (0 – 17.90l)
29	High minute volume alarm	Value to trigger the minute volume alarm (high)	ml	10 – 18000 (0.01l – 18l)
30	Low etCO ₂ Alarm	Low end tidal CO ₂ concentration alarm	etCO ₂ Units (as shown in parameter 54)	0 – 145
31	High etCO ₂ Alarm	High end tidal CO ₂ concentration alarm	etCO ₂ Units (as shown in parameter 54)	5 – 150
32	Low spO ₂ Alarm	Low spO ₂ Concentration Alarm	%	1 – 98
33	High spO ₂ Alarm	High spO ₂ Concentration Alarm	%	2 – 99 and '-' when OFF
34	Low Pulse Rate Alarm	Low pulse rate alarm	Beats/min	30 – 230
35	High Pulse Rate Alarm	High pulse rate alarm	Beats/min	35 – 235 '-' when OFF
36	Measured RR (Respiratory Rate)	Total breath count over the last minute	Breaths/min	0 – 255
37	Measured CPAP	Measured CPAP value	0.1 * pressure units	- 1 – 32767 (-0.1 – +3276.7 mbar) - 1 – 32767 (-0.1 – +3276.7 cmH ₂ O)
38	Measured Ti	Measured inspiratory time.	0.01s	0 – 9900 (0.00 –99.0s)
39	Measured Vinsp	Measured inspiratory volume	0.1ml	0 – 32767 (0 – 3.2767l)
40	Measured Vte	Measured expiratory volume	0.1ml	0 – 32767 (0 – 3.2767l)
41	Measured PEEP	Measured PEEP value	0.1 * Pressure Unit	- 1 – 32767 (-0.1 – +3276.7 mbar) - 1 – 32767 (-0.1 – +3276.7 cmH ₂ O)
42	Measured PIP	Measured PIP value	0.1 * Pressure Unit	- 1 – 32767 (-0.1 – +3276.7 mbar) - 1 – 32767 (-0.1 – +3276.7 cmH ₂ O)

Technical data

N°	Name	Description	Units	Output Range (Physical range)
43	Oxygen Concentration	Measured oxygen concentration as a % of the air composition	%	18– 100 '-' during O2 Calibration
44	Measured HFO Delta P	The difference between maximum and minimum pressures in HFO mode.	Pressure Unit	0 – 255
45	Measured HFO MAP	Measured HFO mean pressure	0.1* Pressure Unit	-2200 – 1100 (-220 – +110 mbar) - 2200 – 1100 (-220 – +110 cmH ₂ O)
46	Trigger Count	Number of breaths triggered by the patient in the last minute	Breaths/min	0 – 255
47	Measured Minute Volume	Measured volume change in the last minute	ml	0 – 18900l (0.00 – 18.9l)
48	Leak	Measured % of air leaking from the system	%	0 – 99
49	Resistance	Measured airway resistance	0.1 (mbar or mmH ₂ O/s/litre)	0 – 9990 (0 – 999 mbar/l/s or cmH ₂ O/l/s)
50	Compliance	Measured dynamic airway compliance	0.1 ml/mbar (0.1 ml/ Pressure Unit)	0 – 254 (0.0 – 25.4 ml/mbar or ml/cmH ₂ O)
51	C20/C	The ratio of the compliance over the last 20% of the pressure rise compared to total compliance	0.1	0 – 99 (0.0 – 9.9)
52	DCO ₂	Gas transport coefficient	1	0 – 65534
53	etCO ₂	Measured End tidal CO ₂ pressure	mmHg	0 – 150 (mmHg)
54	etCO ₂ Units	etCO ₂ Pressure Units	N/A	0 = mmHg, 1 = Volume Percentage, 2 = kPa
55	SpO ₂	Oxygen saturation	0.1%	0 – 250 (0.0 – 100.0%)
56	Pulse Rate	Pulse rate	Beats/minute	25 – 239
57	PCO ₂	Carbon Dioxide partial pressure	mmHg	0 – 2000 (0.0 – 200.0 mmHg)
58	PO ₂	Oxygen partial pressure	mmHg	0 – 2000 (0.0 – 200.0 mmHg)
59	Unassigned	N/A	N/A	'-'
60	Unassigned	N/A	N/A	'-'
61	Unassigned	N/A	N/A	'-'
62	Unassigned	N/A	N/A	'-'
63	Alarm Status	The current active alarm. See (Table 6)	N/A	See Alarm Table

Alarm Table

Alarm Code	Alarm Description
1	O2 sensor disconnected. Please reconnect.
2	The oxygen cell needs calibrating.
3	A new oxygen cell is required.
4	O2 calibration fail
5	High Oxygen Level.
6	Low Oxygen level.
15	Pressure sensor fault. Remove ventilator from use.
16	High Pressure Threshold Exceeded.
17	Low Pressure
18	Apnoea.
19	Cycle Fail.
20	Continuing Positive Pressure
21	High CPAP
22	High PEEP
23	High PIP
24	Low PIP
25	Monitor isolated communication error. Restart ventilator.
26	Monitor isolated system error. Restart ventilator.
27	Unable to calibrate Flow ADC. Note: applicable for Engineering Utility
28	Calibrate Flow Sensor.
29	Unable to calibrate flow sensor.
30	Flow sensor is not connected.
31	Flow sensor is defective.
32	Flow sensor is contaminated.
40	Alarm system failure. Remove ventilator from use.
41	Not used in V2.0.90
45	Battery low.
46	Main Power Fail.
47	Battery fault. Remove ventilator from use.
48	Battery low.
50	High Minute Volume
51	Low Minute Volume
52	Low Tidal Volume
53	High Patient Leak.
54	Apnoea
55	Breath Not Detected.
56	High Tidal Volume
60	Blocked Fresh Gas. Check patient circuit.
61	Leaking Fresh Gas. Check patient circuit.

Alarm Code	Alarm Description
62	No O2 Supply
63	No Air Supply
64	No Gas.
68	User interface has reset. Confirm settings.
71	Controller system error. Restart ventilator.
72	Controller hardware error. Restart ventilator.
73	Alarm system failure. Remove ventilator from use.
75	Check data output. Note: The alarm changes to Status message when reset.
80	Sub Ambient Pressure - 1
81	Sub Ambient Pressure - 2
82	Flow Sensor Clipping
83	Flow Sensor Reversed
90	Unexpected Rise in Mean Pressure
91	Unexpected Drop in Mean Pressure
96	Pressure change detected.
97	Unexpected Rise in Delta Pressure.
98	Unexpected Drop in Delta Pressure.
99	High PAW
100	Internal communication fault. Remove ventilator from use.
101	System Fail 101 (Memory Checksum Error) – redundant alarm
102	System Fail 102 (Memory Checksum Error) – redundant alarm
103	System Fail 103 (Memory Checksum Error) – redundant alarm
104	System Fail 104 (Memory Checksum Error) – redundant alarm
105	System Fail 105 (Memory Checksum Error) – redundant alarm
106	Ventilator out of calibration. Remove ventilator from use.
114	Power supply error. Note: Whenever the monitor sub system fails to communicate with the power supply a resettable
115	Power supply fault. Remove ventilator from use.
116	Monitor hardware fault. Remove ventilator from use.
117	Monitor hardware fault. Remove ventilator from use.
118	Power supply fault. Restart ventilator. Note: When the "Power supply error." alarm is activated for more than 5 occurrences, the message changes to
120	High Respiratory Rate
255	UI internal communication error. Restart ventilator.
End tidal CO2 Alarm	
151	SpO2/etCO2 Hardware Fault
180	No etCO2 Module Connected
181	etCO2 Module Fault - 1

Alarm Code	Alarm Description
182	etCO2 Module Fault - 2
183	etCO2 Module Fault - 3
184	etCO2 Calibration Is Due NB: Status message
185	etCO2 Maintenance Is Due NB: Status message
186	No etCO2 FilterLine connected
189	Replace etCO2 FilterLine
190	etCO2 Module Fault - 4
191	etCO2 Module Fault - 5
192	Invalid CO2 Value
193	CO2 value over-range
194	No etCO2 Breath
197	High etCO2
198	Low etCO2
201	High CO2
202	Low CO2
203	High etCO2 Spont
204	etCO2 Purge NB: Status message
205	etCO2 Self Maintenance Mode NB: Status message
206	etCO2 Pump Off NB: Status message
207	etCO2 initializing NB: Status message
SpO ₂ Alarm	
151	SpO2/etCO2 Hardware Fault
153	No SpO2 module Connected
154	No SpO2 Sensor Connected
155	SpO2 Hardware Fault - 3
156	SpO2 Hardware Fault - 1
157	Defective SpO2 Sensor - 1
158	Low Perfusion Index (SpO2) NB: Status message
159	Pulse Search NB: Status message
160	SpO2 Sensor Interference Detected
161	SpO2 Sensor Off Patient
162	Too Much Ambient Light (SpO2) NB: Status message
163	Defective SpO2 Sensor - 2
164	Low SpO2 Signal IQ NB: Status message
166	No SpO2 Adhesive Sensor Connected (Continue without SpO2 sensor)
167	SpO2 Hardware Fault - 2
168	High SpO2

Alarm Code	Alarm Description
169	Low SpO2
170	High Pulse Rate
171	Low Pulse Rate
172	Pulse Not detected (SpO2)
173	No SpO2 Cable Connected (Continue without SpO2 sensor)
84	Monitor communication error. Restart ventilator.
208	O2 > 60%
210	OxyGenie not available.
211	Oxygenie Unexpected reset

28.3 SLE6000 enhanced data output (V3.0)

The SLE6000 enhanced data output is the requested protocol used to output enhanced data from the ventilator to an external medical monitor.

The data is a comma delimited ASCII string of 70 device parameters.

28.3.1 SLE6000 enhanced data output specifications (V3.0)

SLE6000 basic data output contains a Header, Data and Footer format.

Header	Data	Footer
Device ID, Version, Pressure Units, Number of Parameters	70 Parameters, Comma separated	CRC, Carriage Return, Line Feed

The data is output at a fixed baud rate, with no parity bits. The V3 protocol is predominantly a unidirectional protocol, however it must be requested by connected medical monitor.

To enable the V3 protocol, send the string:

SLE6000,V3.0

This must be periodically sent by the connected medical monitor. If not received within 30 seconds of the last receipt, the default V2 protocol is output.

28.3.2 Communications Settings (V3.0)

The SLE Protocol is transmitted using an RS232 format, with a fixed baud rate. The communication interface uses the following RS232 settings:

Setting Type	Value
Baud Rate	19,200 bps
Parity	None
Data Bits	8
Stop Bits	1
Data Format	ASCII Text String
Flow Control	None

28.3.2.1 Data Rate & Size (V3.0)

The transmission of the data string begins every 1 second. The maximum size of each ASCII string is 512 bytes.

28.3.2.2 Data Format

Data within the SLE6000 basic data output is implemented as a comma delimited ASCII string format. All valid data is represented using alphanumeric characters. Characters are used to represent data which is out of range or invalid for a different reason and will be used in place of the parameter value.

Character(s)	Use case	Description
'?'	Invalid data	Data which is unknown or has timed out will be replaced by '?'.
'-'	Data is out of range	Each data has an associated range. Data which is out of this range is replaced by '-'
','	Separation of parameters	
<CR><LF>	End of output string	Carriage return, Line Feed. Used to indicate the end of a data transmission

28.3.3 Data Layout

An example of the output is shown below. The header and footer sections are shown in bold the data is in italics.

Header	Data
SLE6000,V3.0,0,70,-,0,-,10,65,66,-,-,-,-,-,0,0,-,50,4,-,-,35,15,10,50,580,700,10,600,0,18000,-,-,-,-,-,0,0,0,0,-,32767,21,-,-,0,-,-,32767,-,-,-,-,-,-,-,-,-,-,17,80,-,-,-,-,-,2344	<i>SLE6000,V3.0,0,70,-,0,-,10,65,66,-,-,-,-,-,0,0,-,50,4,-,-,35,15,10,50,580,700,10,600,0,18000,-,-,-,-,-,0,0,0,0,-,32767,21,-,-,0,-,-,32767,-,-,-,-,-,-,-,-,-,-,17,80,-,-,-,-,-,2344</i>
Footer	

Header Format

Parameter Name	Description	Value
Ventilator ID	Unique to each type of ventilator. i.e. "SLE6000"	SLE6000
Version ID	Protocol Version ID	V3.0
Pressure Units	The units of all displayed pressure values. mbar or cmH ₂ O	'0' - mbar, '1' - cmH ₂ O
Parameter Number	The number of parameters output.	70

Footer Format

Description	Number of Characters	Range
CRC Value	4	0000 – FFFF
Carriage Return	1	<CR> (0x0D)
Line Feed	1	<LF> (0x0A)

28.3.4 Data Format

The data contains 70 parameters which are outputted in a fixed order. Each parameter has a defined limit and scaling. Each parameter is output in integer format.

The validity of each parameter is checked before transmission by the SLE6000 ventilator.

Note: If the Pressure Units parameter is unknown, then all pressure related parameters are replaced by the invalid data character.

N°	Name	Description	Units	Output Range (Physical range)
1	RR RR Backup (in CPAP, nCPAP S, nCPAP D)	Set Respiratory Rate/ Backup Respiratory Rate (Breaths per minute).	Breaths/min	1 – 150 0 – 10 (nCPAP S) 0 – 60 (DuoPAP) '- ' if RR Backup is Off in CPAP, nCPAP D, nCPAP S
2	CPAP (in CPAP, nCPAP S, nCPAP D modes) PEEP (in CMV, SIMV, PTV, PSV, HFOV+CMV, NIPPV, DuoPAP, NIPPV Tr)	Set CPAP/PEEP value.	0.1 * pressure units	0 – 350 (0.0 – 35.0 mbar or cmH2O) 20 – 150 (2.0 – 15.0 mbar or cmH2O) in nCPAP S, DuoPAP
3	Tidal Volume	Set Target Tidal Volume	0.2ml	10 – 1500 (2.0 – 300ml) 10 – 250 (2.0 – 50ml) HFOV w/o the etCO2 sensor connected 15 – 250 (3.0 – 50 ml) HFOV with the etCO2 sensor connected
4	Ti Ti Max in PSV	Set Target inspiratory time	0.01s	10 – 300 (0.10 – 3.00s)
5	PIP	Set PIP Pressure	Pressure Unit (1 mbar or 1 cmH2O)	0 – 65 (mbar or cmH2O) 2 – 25 (mbar or cmH2O)
6	O2	Set Oxygen Concentration	%	21 – 100
7	HFO Delta P	Set HFO Delta P	Pressure Unit	4 – 180 mbar or cmH2O
8	HFO MAP	Set HFO Mean Pressure	Pressure Unit	0 – 45 (mbar or cmH2O)
9	HFO Frequency	Set HFO Rate	0.1Hz	30 – 200 (3.0 – 20.0Hz)
10	Sigh RR	Backup Respiratory rate in HFO mode	Breaths/min	0 – 150 '- ' if sigh RR is not enabled.
11	Sigh Ti	Inspiratory time in HFO mode, for Sigh breaths	0.01s	10 – 300 (0.10 – 3.00s)
12	Sigh P	Pressure applied in Sigh breaths, HFO mode.	Pressure unit	0 – 45 (mbar or cmH2O)

Technical data

N°	Name	Description	Units	Output Range (Physical range)
13	Ventilation Mode	n/a	n/a	Uses the Breath mode enumerated list: CPAP = 0 CMV = 1 PTV = 2 PSV = 7 SIMV = 3 HFO only = 4 HFO + CMV = 5 nCPAP D = 9 NIPPV (Dual limb) = 10 NIPPV Tr = 11 NHFOV (Dual limb) = 12 NCPAP (Single limb) = 13 DuoPAP = 14 O2 Therapy = 16 Standby = 17
14	VTV Status	N/A	N/A	0 = OFF 255 = ON
15	Termination Sensitivity	Set % of breath maximum flow which triggers breath termination.	%	5 – 50 '-' if P Support is OFF
16	Breath Trigger Threshold	Target trigger threshold	0.1Lpm for low triggering. If Pressure triggered then 0.5%	2 – 200 (0.2 – 20.0 l/min for flow triggering; 1 – 100% for Pressure Triggering)
17	Rise Time	Time taken for pressure curve to reach 99% of the target pressure	10ms	0 – 300 (0.00 – 3.00s) '-' if not available.
18	Set Flow (O2 Mode)	Expiratory port flow whilst in O2 support mode.	0.1 l/min	20 – 300 (2.0 – 30.0 l/min)
19	Nebuliser Enabled	Nebuliser is connected and enabled.	ON/OFF	255 = ENABLED 0 = DISABLED
20	Patient Leak alarm	Leak alarm value	%	5 – 50 = ON '-' = OFF
21	Apnoea Alarm	Time taken to trigger the apnoea alarm	Seconds	5 – 60 '-' if Apnoea alarm is turned off
22	Low pressure alarm Low Paw alarm in HFOV, HFOV+ CMV and nHFOV	Value to trigger a low pressure alarm	0.1 * Pressure Unit	-100 to +340 (-10 to +34 mbar or cmH2O) in conventional and NIV modes -650 to +340 (-65 to +34 mbar or cmH2O) in HFOV, nHFOV -750 to +340 (-75 to +34 mbar or cmH2O) in HFO+CMV
23	High PEEP Alarm High CPAP Alarm in CPAP, nCPAP D and nCPAP S	High PEEP alarm threshold.	0.1*Pressure Unit	10 – 450 (1 – 45 mbar or cmH2O) 10 – 250 (1- 25 mbar or cmH2O) in nCPAP S and DuoPAP
24	Cycle Fail alarm	Cycle fail alarm threshold.	0.1 * Pressure Unit	0 – 640 (0 – 64 mbar or cmH2O) 0 – 240 (0 – 24 mbar or cmH2O) in nCPAP S and DuoPAP

Technical data

N°	Name	Description	Units	Output Range (Physical range)
25	High PIP Alarm High Paw alarm in HFOV, HFOV+ CMV and nHFOV	Value to trigger a high pressure alarm	0.1 * Pressure Unit	50 – 800 (5 – 80 mbar or cmH2O) in CPAP, CMV, SIMV, PTV, PSV, nCPAP D, NIPPV D, NIPPV Tr. 50 - 400 (5 - 40 mbar or cmH2O) in nCPAP S, DuoPAP; 100 – 1550 (10 – 155 mbar or cmH2O) in HFOV, nHFOV; 100 – 1750 (10 – 175 mbar or cmH2O) in HFO+CMV
26	Low tidal volume alarm	Value to trigger a low tidal volume alarm	0.1ml	0 – 3950 (0 – 395ml)
27	High tidal volume alarm	Value to trigger a high tidal volume alarm	0.1ml	10 – 4000 (1 – 400ml) when VTV is OFF 2 – 4000 (0.2 – 400ml) when VTV is ON
28	Low minute volume alarm	Value to trigger the minute volume alarm (low)	ml	0 – 17900 (0 – 17.90l)
29	High minute volume alarm	Value to trigger the minute volume alarm (high)	ml	10 – 18000 (0.01l – 18.00l)
30	Low etCO2 Alarm Low CO2 Alarm in HFOV, HFOV+ CMV	Low end tidal CO2 concentration alarm	etCO2 Units (as shown in parameter 54)	0 – 145
31	High etCO2 Alarm High CO2 Alarm in HFOV, HFOV+ CMV	High end tidal CO2 concentration alarm	etCO2 Units (as shown in parameter 54)	5 -150
32	Low spO2 Alarm	Low spO2 Concentration Alarm	%	1 – 98
33	High spO2 Alarm	High spO2 Concentration Alarm	%	2 – 99 and '-' when OFF
34	Low Pulse Rate Alarm	Low pulse rate alarm	Beats/min	30 – 230
35	High Pulse Rate Alarm	High pulse rate alarm	Beats/min	35 – 235
36	Measured RR (Respiratory Rate)	Total breath count over the last minute	Breaths/min	0 – 255
37	Measured CPAP	Measured CPAP value	0.1 * pressure units	- 90 – +9990 (-9.0 – +999mbar or cmH2O)
38	Measured Ti	Measured inspiratory time.	0.01s	0 – 9900 (0.00 –99.0s)
39	Measured Vinsp	Measured inspiratory volume	0.1ml	0 – 32767 (0 – 3.2767l)
40	Measured Vte	Measured expiratory volume	0.1ml	0 – 32767 (0 – 3.2767l)
41	Measured PEEP	Measured PEEP value	0.1 * Pressure Unit	- 90 – +9990 (-9.0 – +999 mbar or cmH2O)
42	Measured PIP	Measured PIP value	0.1 * Pressure Unit	- 990 – +9990 (-99.0 – +999 mbar or cmH2O)
43	Oxygen Concentration	Measured oxygen concentration as a % of the air composition	%	18 – 100 '-' during O2 Calibration
44	Measured HFO Delta P	The difference between maximum and minimum pressures in HFO mode.	Pressure Unit	0 – 255
45	Measured HFO MAP	Measured HFO mean pressure	0.1* Pressure Unit	-90 – 9990 (-9- +999 mbar or cmH2O)
46	Trigger Count	Number of breaths triggered by the patient in the last minute	Breaths/min	0 – 255

Technical data

N°	Name	Description	Units	Output Range (Physical range)
47	Measured Minute Volume	Measured volume change in the last minute	ml	0 – 18899l (0.00 – 18.9l)
48	Leak	Measured % of air leaking from the system	%	0 – 99
49	Resistance	Measured airway resistance	0.1 (mbar or mmH2O) //s	0 – 9990 (0 – 999 mbar//s or cmH2O//s)
50	Compliance	Measured dynamic airway compliance	0.1 ml/mbar (0.1 ml/ Pressure Unit)	0 – 254 (0.0 – 25.4 ml/mbar or ml/cmH2O)
51	C20/C	The ratio of the compliance over the last 20% of the pressure rise compared to total compliance	0.1	0 – 99 (0.0 – 9.9)
52	DCO2	Gas transport coefficient	1	0 – 65534
53	etCO2	Measured End tidal CO2 pressure	mmHg	0 – 150 (mmHg)
54	etCO2 Units	etCO2 Pressure Units	N/A	0 = mmHg, 1 = Volume Percentage, 2 = kPa
55	SpO2	Oxygen saturation	0.1%	0 – 1000 (0.0 – 100.0%)
56	Pulse Rate	Pulse rate	Beats/minute	25 – 239
57	PCO2	Carbon Dioxide partial pressure	mmHg	0 – 2000 (0.0 – 200.0 mmHg)
58	PO2	Oxygen partial pressure	mmHg	0 – 2000 (0.0 – 200.0 mmHg)
59	Measured PI	Measured Perfusion Index	%	0 - 2000 (0 - 20.00 %) Where: PI Numeric values 0.02 – 0.99 % have resolution +/- 0.01 %; PI numeric values 1 – 9.9 % have resolution +/- 0.1 % and PI numeric values 10 – 20 % have resolution +/- 1 %;
60	Measured SIQ	Measured Signal Inadequacy	%	0 – 255 (0 – 100%)
61	Measured etCO2 Spont	Measured end tidal CO2 spontaneous value	mmHg	0 – 150 (mmHg)
62	Measured % Spont	Measured % spontaneous value	%	0 – 100%
63	Alarm Status	The current active alarm. See (Table 6)	N/A	See SLE Protocol Alarm Table (Table 13)
64	Measured Fresh Gas Flow	Measured value of Fresh Gas	l/min	0 – 500 (0.0 – 50.0l/min)
65	High etCO2 Spont alarm	High end tidal CO2 spontaneous alarm	mmHg	5 – 150mmHg
66	Auto-O2 Status	Automated Oxygen status	%	a) Auto-O2: inactive- RS232 output is 1 b) Auto-O2: active- RS232 output is 2 c) Auto-O2: limit reached- RS232 output is 3 d) Auto-O2: fallback mode- RS232 output is 4 e) Auto-O2: manual override- RS232 output is 5

Technical data

N°	Name	Description	Units	Output Range (Physical range)
67	Set Auto-O2 target range	Automated Oxygen target range set	%	There are 4 available ranges: 90-94% - RS232 output is 1 91-95% - RS232 output is 2 92-96% - RS232 output is 3 94-98% - RS232 output is 4
68	Reference O2 value	Reference value of Oxygen	%	21 – 100%
69	Variance Co-Efficient (deferred)	TBC	TBC	TBC
70	Time in Range (deferred)	TBC	TBC	TBC

Alarm Table

Alarm Code	Alarm Description
1	O2 sensor disconnected. Please reconnect.
2	The oxygen cell needs calibrating.
3	A new oxygen cell is required.
4	O2 calibration fail
5	High Oxygen Level.
6	Low Oxygen level.
15	Pressure sensor fault. Remove ventilator from use.
16	High Pressure Threshold Exceeded.
17	Low Pressure
18	Apnoea.
19	Cycle Fail.
20	Continuing Positive Pressure
21	High CPAP
22	High PEEP
23	High PIP
24	Low PIP
25	Monitor isolated communication error. Restart ventilator.
26	Monitor isolated system error. Restart ventilator.
27	Unable to calibrate Flow ADC. Note: applicable for Engineering Utility
28	Calibrate Flow Sensor.
29	Unable to calibrate flow sensor.
30	Flow sensor is not connected.
31	Flow sensor is defective.
32	Flow sensor is contaminated.
40	Alarm system failure. Remove ventilator from use.
41	Not used in V2.0.90
45	Battery low.
46	Main Power Fail.
47	Battery fault. Remove ventilator from use.
48	Battery low.
50	High Minute Volume
51	Low Minute Volume
52	Low Tidal Volume
53	High Patient Leak.
54	Apnoea
55	Breath Not Detected.
56	High Tidal Volume
60	Blocked Fresh Gas. Check patient circuit.
61	Leaking Fresh Gas. Check patient circuit.

Alarm Code	Alarm Description
62	No O2 Supply
63	No Air Supply
64	No Gas.
68	User interface has reset. Confirm settings.
71	Controller system error. Restart ventilator.
72	Controller hardware error. Restart ventilator.
73	Alarm system failure. Remove ventilator from use.
75	Check data output. Note: The alarm changes to Status message when reset.
80	Sub Ambient Pressure - 1
81	Sub Ambient Pressure - 2
82	Flow Sensor Clipping
83	Flow Sensor Reversed
90	Unexpected Rise in Mean Pressure
91	Unexpected Drop in Mean Pressure
96	Pressure change detected.
97	Unexpected Rise in Delta Pressure.
98	Unexpected Drop in Delta Pressure.
99	High PAW
100	Internal communication fault. Remove ventilator from use.
101	System Fail 101 (Memory Checksum Error) – redundant alarm
102	System Fail 102 (Memory Checksum Error) – redundant alarm
103	System Fail 103 (Memory Checksum Error) – redundant alarm
104	System Fail 104 (Memory Checksum Error) – redundant alarm
105	System Fail 105 (Memory Checksum Error) – redundant alarm
106	Ventilator out of calibration. Remove ventilator from use.
114	Power supply error. Note: Whenever the monitor sub system fails to communicate with the power supply a resettable
115	Power supply fault. Remove ventilator from use.
116	Monitor hardware fault. Remove ventilator from use.
117	Monitor hardware fault. Remove ventilator from use.
118	Power supply fault. Restart ventilator. Note: When the "Power supply error." alarm is activated for more than 5 occurrences, the message changes to
120	High Respiratory Rate
255	UI internal communication error. Restart ventilator.
End tidal CO2 Alarm	
151	SpO2/etCO2 Hardware Fault
180	No etCO2 Module Connected
181	etCO2 Module Fault - 1

Alarm Code	Alarm Description
182	etCO2 Module Fault - 2
183	etCO2 Module Fault - 3
184	etCO2 Calibration Is Due NB: Status message
185	etCO2 Maintenance Is Due NB: Status message
186	No etCO2 FilterLine connected
189	Replace etCO2 FilterLine
190	etCO2 Module Fault - 4
191	etCO2 Module Fault - 5
192	Invalid CO2 Value
193	CO2 value over-range
194	No etCO2 Breath
197	High etCO2
198	Low etCO2
201	High CO2
202	Low CO2
203	High etCO2 Spont
204	etCO2 Purge NB: Status message
205	etCO2 Self Maintenance Mode NB: Status message
206	etCO2 Pump Off NB: Status message
207	etCO2 initializing NB: Status message
SpO ₂ Alarm	
151	SpO2/etCO2 Hardware Fault
153	No SpO2 module Connected
154	No SpO2 Sensor Connected
155	SpO2 Hardware Fault - 3
156	SpO2 Hardware Fault - 1
157	Defective SpO2 Sensor - 1
158	Low Perfusion Index (SpO2) NB: Status message
159	Pulse Search NB: Status message
160	SpO2 Sensor Interference Detected
161	SpO2 Sensor Off Patient
162	Too Much Ambient Light (SpO2) NB: Status message
163	Defective SpO2 Sensor - 2
164	Low SpO2 Signal IQ NB: Status message
166	No SpO2 Adhesive Sensor Connected (Continue without SpO2 sensor)
167	SpO2 Hardware Fault - 2
168	High SpO2

Alarm Code	Alarm Description
169	Low SpO2
170	High Pulse Rate
171	Low Pulse Rate
172	Pulse Not detected (SpO2)
173	No SpO2 Cable Connected (Continue without SpO2 sensor)
84	Monitor communication error. Restart ventilator.
208	O2 > 60%
210	OxyGenie not available.
211	Oxygenie Unexpected reset

28.4 Vuelink & IntelliBridge EC10

Caution: Use of the alarm data communicated from the RS232 port is for information only and does not remove the need to monitor both the patient or ventilator at regular intervals.

28.4.1 Connecting to the VueLink patient monitor

The SLE6000 RS232 link has been adapted for Philips Open Interface/VueLink module. Connection to the monitor must be via the VueLink module. (Philips P/N° M1032A) The module must be of the 'Ventilator' type.

The cable from the M1032A module (Philips P/N° M1032-61654) requires the SLE VueLink adaptor (SLE P/N° W0344) to connect it to the 9-pin RS232 socket on the back of the SLE6000 ventilator.

The transmission speed is 19200 bps, data format 8 bits, 1 stop bit and no parity. All data transmitted to the VueLink monitor is transferred in packets or telegrams. The VueLink monitor sends data request telegrams and the SLE6000 sends response telegrams.

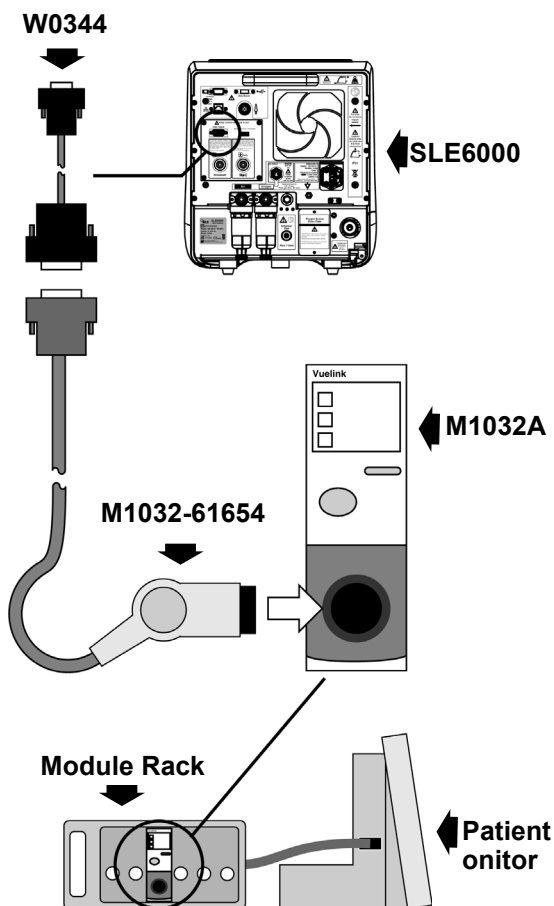

28.4.2 Connecting to the IntelliBridge EC10 module

The SLE6000 RS232 link has been adapted for Philips IntelliBridge EC10 Interface Module. (Philips P/N° 865115 #A01,101)

Connection to the monitor must be via the Philips IntelliBridge EC5 ID module (Philips P/N°865114 #101 DB9) and standard ethernet cable CAT5 with RJ45 connectors to the 9-pin RS232 socket on the back of the SLE6000 ventilator. (Philips P/N° 865114 #L02*) *(#L01 = 1.5m, #L02 = 3m & #L03 10m)

The IntelliBridge items can be purchased either from SLE or your Philips distributor. The transmission speed is 19200 bps, data format 8 bits, 1 stop bit and no parity. All data transmitted to the IntelliVue monitor is transferred in packets or telegrams. The IntelliVue monitor sends data request telegrams and the SLE6000 sends response telegrams.

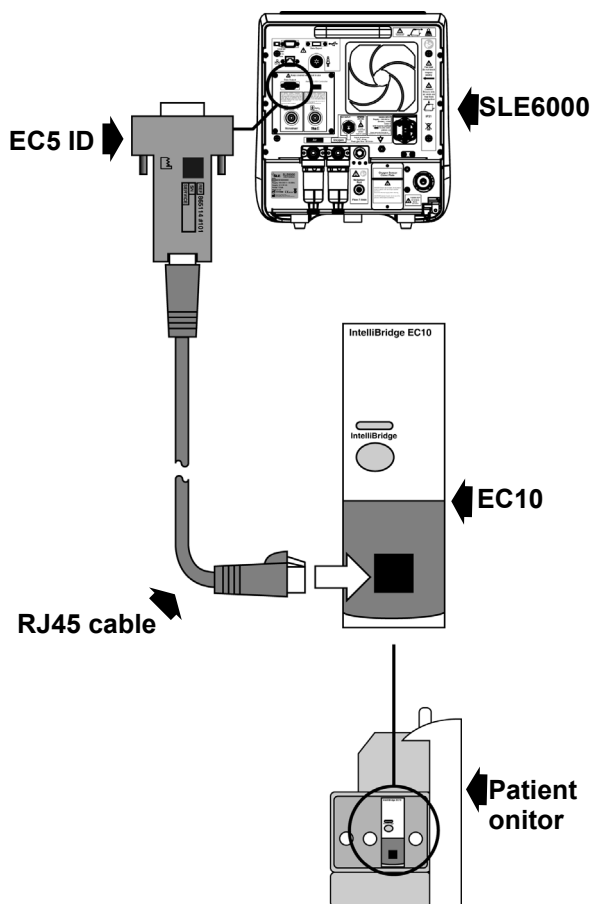

28.4.3 Parameter Descriptions

Parameter N°	SLE 6000 Label	Philips Monitor Label	Param Type	Default value to display	Available on Vuelink
Waveform	Pressure (waveform)	AWP (Airway Pressure Wave)	Waveform	Flat line	Yes
Waveform	Flow (waveform)	AWF (Airway Flow Wave)	Waveform	Flat line	Yes
Waveform	Volume (waveform)	AWV (Airway Volume Wave)	Waveform	Flat line	Yes
Waveform	CO2 (waveform)	CO_2(Airway CO2 Wave)	Waveform	Flat line	Yes
Waveform	Pleth (waveform)	SpO_2 (SPO2 Wave)	Waveform	Flat line	Yes
1	Meas RR(BPM)	AWRR (Airway Respiration rate – airway measurement)	Measurement	-1	Yes
2	AWRR (Alarm limit)	High	Alarm Limit	-1	No
3	PIP	PIP (peak inspiratory pressure in mbar)	Measurement	0	Yes
4	PIP (Alarm limits)	High and Low	Alarm Limit	0	No
5	PEEP/CPAP	PEEP (positive end expiratory pressure in mbar)	Measurement	0	Yes
6	PEEP/CPAP (alarm limits)	High and Low	Alarm Limit	0	No
7	Ti	InsTi (Inspiratory Time)	Measurement	-1	Yes
8	Texp	ExpTi (Expiratory Time)	Measurement	-1	Yes
9	Vte	TVex (Expiratory tidal volume in ml)	Measurement	-1	Yes
10	Vte(Alarm limits)	High and Low	Alarm Limit	-1	No
11	Vmin	MINVOL (Minute Volume)	Measurement	-1	Yes
12	Vmin(Alarm limits)	High and Low	Alarm Limit	-1	No
13	O2	inO_2 (Inspired Oxygen)	Measurement	0	Yes
14	Vti	TVin (Inspired tidal volume in ml)	Measurement	0	Yes
15	HFO delta P	HFVAmp (High freq ventilation resp. amplitude) although Δp is available (if preferred)	Measurement	0	Yes
16	C20/C	C20/C (Overdistension Index)	Measurement	-1	Yes
17	DCO2	DCO_2 (High Frequency Gas Transport Coefficient value)	Measurement	-1	Yes
18	Mean P	MnAwP or Pmean? (Mean airway Pressure)	Measurement	0	Yes
19	Compl.	Cdyn (Dynamic Lung Compliance)	Measurement	-1	Yes
20	Resist.	Rdyn (Dynamic Lung Resistance)	Measurement	-1	Yes
21	Leak	Leak (leakage in percent)	Measurement	255	Yes
22	Leak (Alarm Limits)	High	Alarm Limit	100	No
23	etCO2	ETCO_2 (End-tidal CO2)	Measurement	-1	Yes
24	etCO2 (Alarm limits)	High and Low	Alarm Limit	-1	No
25	SpO2	SpO_2 (Percent Oxyhemoglobin Saturation)	Measurement	0	Yes
26	SpO2 (Alarm Limits)	High and Low	Alarm Limit	100	No
27	fgFlow	fgFlow (Total Fresh gas flow)	Measurement	0	Yes
28	Pulse	PULSE (Pulse Rate)	Measurement	-1	Yes
29	Pulse (Alarm Limits)	High and Low	Alarm Limit	-1	No
30	Trig (eg in CPAP)	SpAWRR (Spontaneous Airway Respiration Rate)	Measurement	-1	Yes
31	Vent Mode	sMode (Enumeration Setting: Mode)	Setting	Standby	No
32	High PIP/PAW	highP (Alarm Limit: High Pressure)	Alarm Limit	0	No
33	Set RR	sAWRR (Set Airway Respiratory Rate measured in rpm)	Setting	0	No
34	Set Ti	sInsTi (set Inspiratory Time in seconds)	Setting	0	No
35	Set HFO Freq	sHFVRR (Set High frequency ventilation respiration rate in Hz)	Setting	0	Yes

Technical data

Parameter N°	SLE 6000 Label	Philips Monitor Label	Param Type	Default value to display	Available on Vuelink
36	Set PEEP/CPAP	sPEEP (set PEEP in mbar)	Setting	0	No
37	Set Vte	sTV (set tidal volume in ml)	Setting	0	No
38	Set PIP	sPIP (set PIP in mbar)	Setting	0	No
39	Set O2	sO2 (Setting: Oxygen Concentration in %)	Setting	0	No
40	Set HFO delta P	sHFVAm (set high frequency ventilator amp)	Setting	0	No
41	Set HFO Mean	sHFMAP (Setting: Mean Airway Pressure, around which High Frequency Oscillations occur)	Setting	0	No
42	Breath Trig Threshold	sTrgFI (set Flow Trigger)	Setting	0	Yes
43	Apnoea alarm time	sAADel (Apnoea Alarm Delay)	Setting	0	No
44	Set flow	sfgFI (Setting: total fresh gas flow on the mixer)	Setting	0	No
45	Backup RR	sRRbak (Setting: Backup Respiration Rate of ventilator)	Setting	0	No
47	Trigger sensitivity (not flow)	sTrig (Setting: Trigger Sensitivity)	Setting	0	No
48	sSpO2	sSpO2 (Midpoint of target range)	Setting	0	No
49	Perf	Perfusion	Measurement	0	No

28.4.4 Alarm messages

Philips Message Type	Philips alarm message	6000 Alarm (ID)	Affected Parameters
1 General Hard Inop	"VENT NOOPERATIVE" (data not available)	Alarm system failure (40,73) Power supply error (114, 118) Power supply fault (115) Ventilator out of calibration (106) Monitor hardware fault. (117) Controller hardware error (72) Controller system error (71) Monitor hardware fault (27) Monitor isolated communication (25) Monitor isolated system error (26) Unable to calibrate flow ADC (27) User interface has reset (68) Internal communication fault (100) Check data output (75) Nurse call error (41)	All
2 Specific Hard Inop	"O2 SENSOR" (data not available)	O2 Cell Disconnected (15) O2 Cell Exhausted (3) O2 Cell Cal Fail (4) O2 Cell Calibration	FIO_2
3 Specific Hard Inop	"FLOW SENSOR" (data not available)	Flow sensor defect (31) Flow sensor contaminated (32) Connect flow sensor (30) Cannot Calibrate flow sensor (29) Calibrate flow sensor (28) Flow sensor reverse (83) Flow sensor clipped (82)	TVex TVin MV Cdyn Rdyn Leak C20/C DCO_2
4 Specific Hard Inop	"SPO2 SENSOR" (data invalid useless)	All 14 SPO2 system alarms from excluding External sensor communication error (151)	PULSE SpO_2

Technical data

Philips Message Type	Philips alarm message	6000 Alarm (ID)	Affected Parameters
5 Specific Hard Inop	"ETCO2 SENSOR" (data invalid useless)	All 11 ETCO2 system alarms from excluding External sensor communication error (151)	ETCO_2 PCO_2 PO_2
6 Specific Soft Inop	"PR. SENS. DRIFT" (data invalid useless)	Pres. Sens. Drift (15)	PEEP/CPAP PIP HFVAm MnAwP Cdyn Rdyn
7 Red Alarm	"LOW PRESSURE"	Sust. sub ambient (81) Sub ambient (80) Low PIP (24) Low pressure (17) Mean pressure low (91)	
8 Red Alarm	"HIGH PRESSURE"	Cont. positive press (20) High Pressure (16) High Paw(99) High PIP (23) High CPAP (21) PEEP too high(22) Mean pressure high(91)	
9 Red Alarm	"VENT FAILURE"	Monitor communication error (UI generated alarm) Controller hardware error (72) Ventilator out of calibration (106) Monitor isolated communication error (23) Monitor isolated system error (26) User interface has reset (68) Alarm system failure (40) OxyGenie is not available (210) Auto O2 unexpected reset (211) SpO2/etCO2 Hardware fault (151)	
10 Red Alarm	"CYCLE FAIL"	Fail to cycle (19)	
11 Red Alarm	"PR. SENS. DRIFT"	Pressure sensor fault (15)	PEEP PIP HFVAmp MnAwP Cdyn Rdyn
12 Red Alarm	"HFO P CHANGE"	Pressure MAX change (96) Delta Pressure Rise (97) Delta pressure drop (98)	
13 Red Alarm	"GAS SUPPLY FAIL"	No Gas (64) No O2 Supply (62) No Air Supply (63)	
14 Red Alarm	"BATTERY"	Battery fault (47) Battery Low (45,48)	
15 Red Alarm	"PAT. CIRCUIT"	Blocked Fresh Gas (60) Leaking Fresh Gas (61)	
16 Red Alarm	"APNOEA"	Apnoea Breath (55) Apnoea - Volume (54) Apnoea - Pressure (18)	
17 Red Alarm	"HIGH RR"	High BPM(120)	
18 Yellow Alarm	"AUTO O2"	Fast increase in O2 (209) O2>X% (208)	

Philips Message Type	Philips alarm message	6000 Alarm (ID)	Affected Parameters
19 Yellow Alarm	"SPO2"	All 18 SPO2 system and patient alarms	
20 Yellow Alarm	"ETCO2"	All 17 ETCO2 system and patient alarms	
21 Yellow Alarm	"FLOW SENS ALARM"	Flow sensor defect (31) Flow sensor contaminated (32) Connect flow sensor (30) Cannot calibrate flow (29) Calibrate flow sensor (28) Flow sensor reverse (83) Flow sensor clipped (82)	TVex TVin MV Cdyn Rdyn Leak C20/C DCO_2
22 Yellow Alarm	"VOLUME ALARM"	High Minute Vol (50) Pat. Leak Alarm (53) Low Tidal Vol. (52) High Tidal Vol. (56) Low Minute Vol (51)	
23 Yellow Alarm	"POWER FAIL"	Main Power Fail (46)	
24 Yellow Alarm	"O2 CELL FAIL"	O2 Cell Disconn (1) O2 Cell needs cal(2) O2 Cell needs repl (3) O2 Cell Cal Fail (4)	FIO_2
25 Yellow Alarm	"O2 "	High O2 Level (5) Low O2 Level (6)	

28.4.5 Waveform

AWP (airway pressure)
AWF (airway flow)
AWV (airway volume)
CO_2 (Carbon dioxide wave - airway)
PLETH (PLETH wave delivered by the SpO_2 parameter)

28.4.6 VueLink Task Window Layout

The VueLink task window for the SLE6000 will display the parameters as shown below.

```

|-----|-----|-----|
| AWRr   rpm   | TVex   ml   | sHFVRR Hz   |
|-----|-----|-----|
| PIP    mbar  | MV     l    | MnAwP  mbar  |
|-----|-----|-----|
| PEEP   mbar  | Leak   %   | HFVAmp  mbar  |
|-----|-----|-----|
| InsTi  sec   | Cdyn   ml/mbar | DCO_2     |
|-----|-----|-----|
| ExpTi  sec   | Rdyn   mbar/l/s | fgFlow  l/min  |
|-----|-----|-----|
| SpAWRR rpm   | TVin   ml   | ETCO_2  mmHg  |
|-----|-----|-----|
|         | C20/C          | SpO_2   %   |
|-----|-----|-----|
| FIO_2  %     | sTrgFl  l/min  | PULSE   bpm   |
|-----|-----|-----|
    
```

28.5 Nurse call

Warning. Use of the nurse call function does not remove the need to monitor both the patient or ventilator at regular intervals.

When connected to a hospital nurse call system the ventilator will generate an activation signal on the following alarm conditions:

Condition 1. Any high priority alarm (Patient & Technical)

Condition 2. A monitor system failure

Condition 3. A total power failure or shutdown of the ventilator.

When the high priority alarm is cleared the activation signal for the nurse call system is cancelled.

Pressing the ventilators ON/OFF button shall deactivate the nurse-call activation signal for conditions 2 and 3.

Note: For alarm condition 3 the duration of the alarm activation signal is approximately 2 to 9 minutes.

28.5.1 Nurse call delay

The delay in activation of the nurse call alarm is 5ms.

28.6 Ethernet

The ethernet port is non-functional in this release of software.

28.7 USB (Data)

The ventilator is supplied with one bi-directional USB 2.0 data port. The port is utilised in the export of patient log, event log, and screen captures, plus in the upgrade of ventilator software.

28.8 USB (Power)

The ventilator is supplied with one USB 2.0 power port. The port is utilised to power USB powered ultrasonic nebuliser. The port is active when the ventilator is turned on.

28.9 External Monitor

The external monitor output allows the ventilator to connect any medical grade monitor that can display XGA outputs at a resolution of 1024 x 768 pixels.

Note: The external monitor must be connected to the VGA output port or DisplayPort output port (depending on model) prior to the ventilator being switched on. The ventilator only checks for external monitors on power up.

Warning. An external monitor should not be connected to the ventilator when being used clinically. The external monitor should only be used for demonstrations or training purposes.

29. Input ports (Electrical)

29.1 SpO₂ and etCO₂

Both SpO₂ and etCO₂ devices are type BF applied parts.

29.2 Flow sensor

The flow sensor is a type BF applied part.

29.3 DC 24V

This port is to allow an external 24V 4A direct power supply to be connected.

Caution: Use only a medical grade 24V DC power supply with a current rating of 4A.

30. Sensor Specifications

Note: Additional information on sensor accuracy can be found with the instructions for use supplied with the sensor.

30.1 Masimo SET®

Patent information . . . www.masimo.com/patents.htm

30.1.1 Functional SpO₂ (%)

Specification Criteria

Display Range 0.0% -100.0%

Calibration Range . . . 70%-100%

Calibration Standard. Invasive Co-oximeter

No motion Accuracy - Infant and Paediatric sensors (rms)..... ≤2.0%

No motion Accuracy - Neonatal sensors (rms). ≤3.0%

Motion Accuracy

(rms). ≤3.0%

Resolution ≤0.1 %

Time to Display. ≤8 seconds

Asystole Detection

Time ≤8 seconds

Delay ≤10 seconds

Response Time ≤20 seconds

Display Update

Frequency ≥ 1 Hz

Average Time

(seconds) 2-4, 4-6, 8, 10, 12, 14, 16

30.1.2 Pulse rate (BPM)

Specification Criteria

Display Range 25 BPM - 239 BPM

Calibration Range . . . 25 BPM - 239 BPM

Calibration Standard. ECG and Patient Simulator

No motion Accuracy

(rms). ≤ 3.0 BPM

Motion Accuracy

(rms). ≤ 5.0 BPM

Resolution ≤ 1 BPM

Time to Display. ≤8 seconds

Asystole Detection

Time ≤8 seconds

Delay ≤10 seconds

Response Time ≤20 seconds

Display Update

Frequency ≥ 1 Hz

30.1.3 Perfusion index (%)

Specification Criteria

Display Range 0.02% - 20.0%

Calibration Range . . . 0.10% - 20.0%

Calibration Standard . Patient Simulator

Resolution $\leq 0.01\%$

Time to Display

Asystole Detection

Time ≤ 8 seconds

Delay ≤ 10 seconds

Response Time ≤ 20 seconds

Display Update

Frequency ≥ 1 Hz

30.1.3.1 Sensor Wavelength range

Masimo sensor Wavelength range = 653-905nm

Masimo sensor Output power ≤ 15 mW

30.1.4 Accuracy notes

1. The Masimo SET technology with Masimo sensors has been validated for no motion accuracy in human blood studies on healthy adult male and female volunteers with light to dark skin pigmentation in induced hypoxia studies in the range of 70-100% SpO₂ against a laboratory CO-Oximeter and ECG monitor. This variation equals ± 1 standard deviation. Plus or minus one standard deviation encompasses 68% of the population.

2. The Masimo SET technology with Masimo sensors has been validated for motion accuracy in human blood studies on healthy adult male and female volunteers with light to dark skin pigmentation in induced hypoxia studies while performing rubbing and tapping motions, at 2 to 4 Hz at an amplitude of 1 to 2 cm and a non-repetitive motion between 1 to 5 Hz at an amplitude of 2 to 3 cm in induced hypoxia studies in the range of 70-100% SpO₂ against a laboratory CO-Oximeter and ECG monitor. This variation equals ± 1 standard deviation, which encompasses 68% of the population.

3. The Masimo SET technology has been validated for low perfusion accuracy in bench top testing against a Biotek Index 2™ simulator and Masimo's simulator with signal strengths of greater than 0.02% and transmission of greater than 5% for saturations ranging from 70 to 100%. This variation equals ± 1 standard deviation. Plus or minus one standard deviation encompasses 68% of the population.

4. The Masimo SET Technology with Masimo Neo sensors has been validated for neonatal motion accuracy in human blood studies on healthy adult male and female volunteers with light to dark skin pigmentation in induced hypoxia studies while

performing rubbing and tapping motions, at 2 to 4 Hz at an amplitude of 1 to 2 cm and a non-repetitive motion between 1 to 5 Hz at an amplitude of 2 to 3 cm in induced hypoxia studies in the range of 70-100% SpO₂ against a laboratory CO-Oximeter and ECG monitor. This variation equals ± 1 standard deviation. Plus or minus one standard deviation encompasses 68% of the population. 1% has been added to the results to account for the effects of fetal hemoglobin present in neonates.

5. The Masimo SET technology with Masimo sensors has been validated for pulse rate accuracy for the range of 25 - 239 BPM in bench top testing against a Biotek Index 2™ simulator. This variation equals ± 1 standard deviation. Plus or minus one standard deviation encompasses 68% of the population.

6. See sensor directions for use (DFU) for complete application information. Unless otherwise indicated, reposition reusable sensors at least every 4 hours and adhesive sensors at least every 8 hours.

7. Sensor accuracy specified when used with Masimo technology using a Masimo patient cable for LNOP sensors, RD SET sensors, the LNCS sensors, or the M-LNCS sensors. Numbers represent Arms (RMS error compared to the reference). Because pulse oximeter measurements are statistically distributed, only about two-thirds of the measurements can be expected to fall within a range of \pm Arms compared to the reference value. Unless otherwise noted, SpO₂ accuracy is specified from 70% to 100%. Pulse Rate accuracy is specified from 25 to 240 bpm.

8. Masimo M-LNCS, LNOP, RD SET, and LNCS sensors types have the same optical and electrical properties and may differ only in application type (adhesive/non-adhesive/hook & loop), cable lengths, optical component locations (top or bottom of sensor as aligned with cable), adhesive material type/size, and connector type (LNOP 8 pin modular plug, RD 15 pin modular plug, LNCS 9 pin, cable based, and M-LNCS 15 pin, cable based). All sensor accuracy information and sensor application instructions are provided with the associated sensor directions for use.

30.1.5 Environmental

30.1.5.1 Operating Conditions

Incandescent Light
 Intensity. 100 k Lux (Sunlight)
 Fluorescent Light
 Intensity. 10 k Lux
 Fluorescent Light
 Frequency 50, 60 Hz ± 1.0 Hz
 Temperatures @
 ambient humidity 5°C to 40°C
 Humidity 15% to 95%, non-condensing
 Pressure 500 to 1060 mbar

30.1.5.2 Storage Conditions

Temperature@
 ambient humidity -40°C to 70°C
 Humidity 15% to 95%, non-condensing

30.1.5.3 Implied license statement

Possession or purchase of this device does not convey any express or implied license to use the device with un-authorized sensors or cables which would, alone or in combination with this device, fall within the scope of one or more of the patents relating to this device.

30.2 MicroPod™

Patent information . . . US Patents:
 www.covidien.com/patents
 CO₂ Units mmHg or kPa or Vol%
 CO₂, etCO₂ Range . . 0-150 mmHg
 CO₂ Waveform
 Resolution 0.1 mmHg
 EtCO₂ Resolution . . . 1 mmHg
 CO₂ Accuracy* 0-38 mmHg: ± 2 mmHg
 39-150 mmHg: ± (5% of expected reading in mmHg + [0.08 x (expected reading in mmHg – 39mmHg)])**

Accuracy in the presence of interfering gases The accuracy specification is as described below in the presence of interfering gases.

0-38 mmHg: ± (2 mmHg + 4% of the expected reading in mmHg)

39-150 mmHg: ± (9% of expected reading in mmHg + [0.08 x (expected reading in mmHg – 39mmHg)])

Respiration Rate
 Range 0-150 bpm

Respiration Rate
 Accuracy The accuracy test is described in the SLE6000 service manual.
 0-70 bpm: ±1 bpm
 71-120 bpm: ±2 bpm
 121-150 bpm: ±3 bpm

Drift of measurement accuracy Regarding drift, please note that the periodic auto zero function compensates for drifts between components, changes in ambient temperature, and barometric conditions. This automatic process eliminates variances that might otherwise cause measurement drift. Therefore the module does not exhibit drift.

Flow Rate 50 (tolerance -7.5, +15) ml/min, flow measured by volume

Waveform Rise Time	
10% to 90%	1.72 seconds
Waveform Sampling .	20 samples/s
Initialization Time . . .	40 s (typical, includes power-up and initialization time)
* In cases where the requirements of ISO 80601-2-55 are more stringent than the accuracy indicated by the table above, the MicroMediCO2 complies with the more stringent requirements.	
**For breath rates above 80 bpm, accuracy is 4 mmHg or ±12 % of reading (whichever is greater) for etCO ₂ values exceeding 18 mmHg.	
Peak picking	The module selects the peak etCO ₂ value in a twenty second window and this is displayed in the monitored values panel.
Calibration Interval . .	Initially calibrate after 1,200 operating hours, then once a year or after 4,000 operating hours, whichever comes first. The initial calibration should not occur before 720 hours of use. If the initial calibration is done before 720 hours of use, the module will reset to require its next calibration after 1200 hours, instead of after 4000 hours.
Servicing	After 30,000 operating hours, certain components of the capnography module need servicing.
System Response Time	
etCO ₂	6.83 seconds
Compensation	BTPS (standard correction used by MicroPod™ capnography during all measurement procedures for body temperature, pressure, and saturation)

30.2.1 Alarm limits

Low etCO ₂	0-145 mmHg
High etCO ₂	5-150 mmHg

30.2.2 Measurement formats

The MicroPod™ provides CO₂ data in the following units:

- mmHg.
- % volume
- kPa

30.2.3 Calculation methods for Capnography

Capnography is a non-invasive method for monitoring the level of carbon dioxide in exhaled breath (EtCO₂) to assess a patient's ventilatory status.

Microstream™ capnography modules uses Microstream™ non-dispersive infrared (NDIR) spectroscopy to continuously measure the amount of CO₂ during every breath, the amount of CO₂ present at the end of exhalation (EtCO₂), the amount of CO₂ present during inhalation (FiCO₂), and the Respiratory Rate.

Infrared spectroscopy is used to measure the concentration of molecules that absorb infrared light. Because the absorption is proportional to the concentration of the absorbing molecule, the concentration can be determined by comparing its absorption to that of a known standard.

30.2.4 Environmental

30.2.4.1 Operating Conditions

Operating Temperature	0°C to 40°C
Operating Pressure .	57kPa to 106kPa (430 mmHg to 795 mmHg)
Operating Altitude . .	-381m to 15,240m (-1250 feet to 50,000 feet)
Altitude change rate	500ft/min (152m/min) maximum or ambient pressure change of 2.4 mmHg/min maximum.
Operating Humidity .	10% to 95% non-condensing

Note: When using module with a ventilator, under high over pressures close to 10kPa (100cmH₂O), the module may enter into a blockage mode in order to protect the module from damage.

30.2.4.2 Storage Conditions

Storage & Transport	
Temperature	-40°C to 70°C.
Storage & Transport	
Humidity	10% to 95% non-condensing
Storage & Transport	
Pressure	57kPa to 106kPa (430 mmHg to 795 mmHg)
Storage & Transport	
Altitude	-1250 feet to 50,000 feet (-381m to 15,240m)

30.2.4.3 Trademarks

Microstream™, MicroPod™, FilterLine™ are trademarks of a Medtronic company.

31. Alarms

The SLE6000 incorporates an intelligent alarm system that priorities the alarm messages, deals with muting of some of the alarms and enables 5 levels of sound adjustments from 20% to 100%.

31.1 Alarm Prioritization

The alarm signals generated by the alarm system are priority encoded, where the high priority alarm signal conveys a higher level of urgency than the medium or low priority alarm signals.

The medium priority alarm signal conveys a higher level of urgency than the low priority alarm signal.

Upon generation of an alarm a message indicating the type of alarm is displayed to the user.

Simultaneously an audible alarm of the correct priority level is sounded. When changing modes, for any alarm that have been triggered the alarm volume level is set to its minimum setting, for a period of 10 seconds. After the 10 seconds has expired the alarm loudness will returns to the user set value.

The operator can inactivate nuisance generation of auditory alarms for maximum period of 2 minutes. The operator can adjust the loudness of the alarm.

Note: In the event of a mains power fail situation there is no change in operation of the alarm system or settings.

31.1.1 Alarm Characteristics

The ventilator produces three types of alarm signals: high, medium and low priority depending on the alarm condition.

The High priority alarm signal consists of 10 pulses. A sequence of 5 pulses repeated once followed by a 10 second gap before restarting.

The Medium priority alarm signal consists of 3 pulses followed by a 20 second gap.

The Low priority alarm signal consists of 2 pulses, alarm is not repeated.

31.1.2 Alarm sounder volume

For maximum volume setting.

High priority alarm: 70 dBA

Medium priority alarm: 70 dBA

Low priority alarm: 70 dBA

31.1.3 Alarm log

The ventilator stores the last 1000 alarm messages in the alarm log. When a new alarm is generated the oldest alarm message is discarded.

The alarm log is retained after powering down the unit or after a total loss of power.

31.2 Alarm Indicators characteristics

Each alarm priority signal is accompanied by an visual alarm, where red colour is used to indicate high priority alarm, amber colour is used to indicate medium priority alarm and cyan colour is used to indicate low priority. The high, medium and low priority alarms have the characteristics detailed below.

Alarm Category	Indicator Colour	Flashing Frequency	Duty Cycle
High priority	Red	1.9 Hz	30% on
Medium priority	Yellow	0.5 Hz	30% on
Low priority	Cyan	Constant (On)	100% on

A		High Pressure Threshold Exceeded.	203
A new oxygen cell is required.	215	High Pulse Rate	226
Alarm system failure	197,	High Respiratory Rate.	214
	217,	High SpO2	226
	218	High Tidal volume	213
Apnoea	213,		
	214	I	
		Internal communication fault	216
		Invalid CO2 Value	229
B		L	
Battery fault	207	Leaking Fresh Gas. Check patient circuit.	208
Battery low.	208	Low CO2	231
Blocked Fresh Gas. Check patient circuit.	208	Low etCO2	230
Breath Not Detected.	213	Low Oxygen Level.	216
		Low Perfusion Index (SpO2)	232
C		Low PIP	204
Calibrate Flow Sensor.	211	Low Pressure	204
Check data output	217	Low Pulse Rate	226
CO2 value over-range	229	Low SpO2	226
Continuing Positive Pressure	202	Low SpO2 Signal IQ	232
Controller hardware error	201	Low Tidal volume	212
Controller system error	202		
Cycle Fail.	205	M	
		Main Power Fail.	214
D		Minute volume below low threshold.	213
Defective SpO2 Sensor - 1	225	Monitor communication error	197
Defective SpO2 Sensor - 2	225	Monitor hardware fault	201,
			207
E		Monitor isolated communication error	209
etcCO2 Self Maintenance Mode	233	Monitor isolated system error	209
etCO2 Calibration Is Due	233		
etCO2 initializing	233	N	
etCO2 Maintenance Is Due	234	No Adhesive SpO2 Sensor Connected	224
etCO2 Module Fault - 1	227	No Air Supply	207
etCO2 Module Fault - 2	227	No etCO2 Breath	230
etCO2 Module Fault - 3	228	No etCO2 FilterLine connected	228
etCO2 Module Fault - 4	228,	No etCO2 Module Connected	227
	229	No Gas	202
etCO2 Pump Off	233	No O2 Supply	206
etCO2 Purge	233	No SpO2 Module Connected	223
		No SpO2 Sensor Connected	224
F		O	
Flow Sensor Clipping	211	O2 Calibration Fail	215
Flow sensor is contaminated.	210	O2 over set limit	216
Flow sensor is defective.	210	O2 sensor disconnected	214
Flow sensor is not connected.	210	OxyGenie is not available	216
Flow Sensor Reversed	211	OxyGenie Unexpected reset	217
H		P	
High CO2	230	Power supply error	198
High etCO2	230	Power supply error. Restart ventilator.	199
High etCO2 Spont	231	Power supply fault	199
High Minute Volume	212	Power supply faulty	221
High Oxygen Level.	215	Pressure change detected.	204
High Patient Leak.	212	Pressure sensor fault	205
High Paw	203		
High PEEP	205		
High PIP	203		

Pulse Not Detected (SpO2)	225
Pulse Search	232

R

Replace etCO2 FilterLine	228
--------------------------------	-----

S

SpO2 Hardware Fault - 1	223
SpO2 Hardware Fault - 2	223
SpO2 Hardware Fault - 3	224
SpO2 Sensor Interference Detected	225
SpO2 Sensor Off Patient	225
SpO2/etCO2 Hardware Fault	223, 227
Sub Ambient Pressure - 1	200
Sub Ambient Pressure - 2	200

T

The oxygen cell needs calibrating.	215
Too Much Ambient Light (SpO2)	232
Total power fail	218

U

UI internal communication error	198
Unable to calibrate flow sensor.	211
Unexpected Drop in Delta Pressure	206
Unexpected Drop in Mean Pressure	206
Unexpected Rise in Delta Pressure	206
Unexpected Rise in Mean Pressure	205
User interface has reset	212

V

Ventilator out of calibration	200
-------------------------------------	-----

31.3 Alarm table

Alarm message: Alarm system failure. Remove ventilator from use.	
Alarm condition: Alarm generator error	Alarm type: Technical
Active in all modes	Alarm ranking: 0
Alarm type: Visual and audible	Alarm priority: High
Latching: Yes	Alarm mutable: No
<p>Definition: This alarm is generated whenever the monitor sub system fails to communicate with the alarm controller. The monitor sub system will attempt to communicate 5 times before initiating the alarm.</p> <p>The alarm history will display "0"</p>	
<p>Ventilator action: The ventilator will display this alarm message and sound the backup sounder. The user cannot cancel the backup sounder alarm tone. If a new alarm is generated the visual component of the alarm is cancelled only. On this action the alarm priority changes to 68.</p>	
<p>User action: Transfer the patient to an alternative form of ventilation. Remove ventilator from service. Route ventilator for repair.</p>	

Alarm message: Monitor communication error. Restart ventilator.	
Alarm condition: Monitor failure	Alarm type: Technical
Active in all modes	Alarm ranking: 0
Alarm type: Visual and audible	Alarm priority: High
Latching: Yes	Alarm mutable: No
<p>Definition: This alarm is generated whenever the user interface can no longer communicate to the monitor subsystem.</p>	
<p>Ventilator action: The ventilator will display this alarm message.</p>	
<p>User action:</p> <p>Step 1. Manually ventilate the patient.</p> <p>Step 2. Record the ventilator settings.</p> <p>Step 3. Enter Standby mode and then restart the ventilator.</p> <p>Step 4. Re-enter the mode of ventilation and reset the ventilator settings recorded prior to restart.</p>	
<p>WARNING: If at this point the alarm message "Monitor communication error. Restart ventilator." reappears transfer the patient to an alternative form of ventilation. Withdraw ventilator from use. Route ventilator for repair.</p>	
<p>Step 5. If required re-calibrate the flow sensor.</p> <p>Step 6. If required turn on etCO₂ / SpO₂ monitoring.</p> <p>Step 7. Reconnect the patient to the ventilator.</p> <p>Step 8. Adjust ventilation parameters if required.</p>	

Alarm message: UI internal communication error. Restart ventilator.	
Alarm condition: User interface error (comms)	Alarm type: Technical
Active in all modes	Alarm ranking: 0
Alarm type: Visual and audible	Alarm priority: High
Latching: Yes	Alarm mutable: No
Definition: This alarm is generated whenever the user interface can no longer communicate to the monitor or controller subsystems.	
Ventilator action: The ventilator will display this alarm message.	
User action: Step 1. Manually ventilate the patient. Step 2. Record the ventilator settings. Step 3. Enter Standby mode and then restart the ventilator. Step 4. Re-enter the mode of ventilation and reset the ventilator settings recorded prior to restart.	
WARNING: If at this point the alarm message “UI internal communication error. Restart ventilator.” re-appears transfer the patient to an alternative form of ventilation. Withdraw ventilator from use. Route ventilator for repair.	
Step 5. If required re-calibrate the flow sensor. Step 6. If required turn on etCO₂ / SpO₂ monitoring. Step 7. Reconnect the patient to the ventilator. Step 8. Adjust ventilation parameters if required.	

Alarm message: Power supply error.	
Alarm condition: Power supply communication error	Alarm type: Technical
Active in all modes	Alarm ranking: 1
Alarm type: Visual and audible	Alarm priority: High
Latching: No	Alarm mutable: No
Definition: This alarm is generated whenever the monitor sub system fails to communicate with the power supply.	
Ventilator action: The ventilator will display this alarm message.	
User action: Step 1. Press Reset	
Note: The user can press reset up a maximum of 5 times. After the fifth reset press a new alarm is generated “Power supply fault. Restart ventilator.”. See “Alarm message: Power supply error. Restart ventilator.” on page 199.	

Alarm message: Power supply error. Restart ventilator.	
Alarm condition: Power supply communication error 1	Alarm type: Technical
Active in all modes	Alarm ranking: 2
Alarm type: Visual and audible	Alarm priority: High
Latching: Yes	Alarm mutable: No
Definition: This alarm is generated whenever the “Power supply error” alarm is acknowledged at least 5 times	
Ventilator action: The ventilator will display this alarm message.	
User action: Step 1. Manually ventilate the patient. Step 2. Record the ventilator settings. Step 3. Enter Standby mode and then restart the ventilator. Step 4. Re-enter the mode of ventilation and reset the ventilator settings recorded prior to restart.	
WARNING: If at this point the alarm message “Power supply error Restart ventilator.” re-appears transfer the patient to an alternative form of ventilation. Withdraw ventilator from use. Route ventilator for repair.	
Step 5. If required re-calibrate the flow sensor. Step 6. If required turn on etCO₂ / SpO₂ monitoring. Step 7. Reconnect the patient to the ventilator. Step 8. Adjust ventilation parameters if required.	

Alarm message: Power supply fault. Remove ventilator from use.	
Alarm condition: Power supply faulty	Alarm type: Technical
Active in all modes	Alarm ranking: 3
Alarm type: Visual and audible	Alarm priority: High
Latching: No	Alarm mutable: No
Definition: This alarm is generated whenever the power supply indicates it is in a fault state. See ““Power supply fault” fault table” on page 219.	
A fault code has been returned by the PSU	
Incorrect PSU type.	
One or both batteries are faulty.	
The batteries are imbalanced.	
One or both batteries are under 14.6V.	
One or both batteries are not of the correct type.	
Ventilator action: The ventilator will display this alarm message.	
User action: Transfer the patient to an alternative form of ventilation. Withdraw ventilator from use. Route ventilator for repair.	

Alarm message: Sub Ambient Pressure - 2	
Alarm condition: Sub ambient Phase 2	Alarm type: Patient
Active in all modes	Alarm ranking: 4
Alarm type: Visual and audible	Alarm priority: High
Latching: No	Alarm mutable: No
Definition: When the proximal pressure falls below -2mbar for greater than 50ms a "Sub ambient Pressure" alarm is generated.	
Ventilator action: Ventilator action: When the monitor subsystem detects the proximal pressure falls below -2mbar for greater than 50ms it instructs the controller sub-system to shut off all gasses. If the gas are not cut off during the next 50ms the monitor subsystem intervenes and cuts off the gasses.	
User action: Check Patient. Check Patient circuit. If alarm persists transfer the patient to an alternative form of ventilation. Withdraw ventilator from use. Route ventilator for repair.	

Alarm message: Sub Ambient Pressure - 1	
Alarm condition: Sub ambient Phase 1	Alarm type: Patient
Active in all modes	Alarm ranking: 5
Alarm type: Visual and audible	Alarm priority: High
Latching: No	Alarm mutable: No
Definition: When the proximal pressure falls below -2mbar for less than 50ms a "Sub ambient Pressure" alarm is generated.	
Ventilator action: When the monitor subsystem detects the proximal pressure falls below -2mbar for less than 50ms it instructs the controller sub-system to shut off all gasses. If the gas are not cut off during the next 50ms the monitor subsystem intervenes and cuts off the gasses.	
User action: Check Patient. Check Patient circuit. If alarm persists transfer the patient to an alternative form of ventilation. Withdraw ventilator from use. Route ventilator for repair.	

Alarm message: Ventilator out of calibration. Remove ventilator from use.	
Alarm condition: Monitor memory Fault	Alarm type: Technical
Active in all modes	Alarm ranking: 6
Alarm type: Visual and audible	Alarm priority: High
Latching: No	Alarm mutable: No
Definition: Stored calibration values have been corrupted. This check only done on start-up. The values can only be cleared by turning the ventilator OFF.	
The nature of the alarms can be read in from the alarm history tab (Limit field).	
See ""Ventilator out of calibration" fault table" on page 220.	
Flow calibration values have been corrupted	
Oxygen calibration values have been corrupted	
Pressure offset calibration values have been corrupted	
Pressure gain calibration values have been corrupted	
Pressure time constant calibration values have been corrupted	
Unable to send calibration data to the isolated side	
Ventilator action: The ventilator will display this alarm message.	
User action: Transfer the patient to an alternative form of ventilation. Withdraw ventilator from use. Route ventilator for repair.	

Alarm message: Monitor hardware fault. Remove ventilator from use.	
Alarm condition: ADC VREF specification	Alarm type: Technical
Active in all modes	Alarm ranking: 7
Alarm type: Visual and audible	Alarm priority: High
Latching: No	Alarm mutable: No
<p>Definition: ADC 2V5 REF is out of spec by at least 20%</p> <p>Other ADC errors are also returned in the alarm history tab (Limit field).</p> <p>The values can only be cleared by turning the ventilator OFF.</p> <p>See ““Monitor hardware fault” fault table” on page 221.</p> <p>2V5 REF (This message will trigger this alarm)</p> <p>8V Standby error (This message will not trigger this alarm)</p> <p>5V Sounder error (This message will not trigger this alarm)</p> <p>3V3 error (This message will not trigger this alarm)</p>	
Ventilator action: The ventilator will display this alarm message.	
User action: Transfer the patient to an alternative form of ventilation. Withdraw ventilator from use. Route ventilator for repair.	

Alarm message: Controller hardware error. Restart ventilator.	
Alarm condition: Control hardware fault	Alarm type: Technical
Active in all modes	Alarm ranking: 8
Alarm type: Visual and audible	Alarm priority: High
Latching: Yes	Alarm mutable: No
<p>Definition: A number of controller faults are grouped together under this alarm. The nature of the alarms can be read in from the alarm history tab (Limit field). See ““Controller hardware fault” fault table” on page 221.</p> <p>Fresh gas module self-test has failed</p> <p>Blender module self-test has failed</p> <p>Breath jet module self-test has failed</p> <p>Controller not responding</p> <p>Controller has reset.</p>	
Ventilator action: The ventilator will display this alarm message.	
<p>User action:</p> <p>Step 1. Manually ventilate the patient.</p> <p>Step 2. Record the ventilator settings.</p> <p>Step 3. Enter Standby mode and then restart the ventilator.</p> <p>Step 4. Re-enter the mode of ventilation and reset the ventilator settings recorded prior to restart.</p>	
<p>WARNING: If at this point the alarm message “Controller hardware error. Restart ventilator.” re-appears transfer the patient to an alternative form of ventilation. Withdraw ventilator from use. Route ventilator for repair.</p>	
<p>Step 5. If required re-calibrate the flow sensor.</p> <p>Step 6. If required turn on etCO₂ / SpO₂ monitoring.</p> <p>Step 7. Reconnect the patient to the ventilator.</p> <p>Step 8. Adjust ventilation parameters if required.</p>	

Alarm message: Controller system error. Restart ventilator.	
Alarm condition: Control UI not responding	Alarm type: Technical
Active in all modes	Alarm ranking: 9
Alarm type: Visual and audible	Alarm priority: High
Latching: No	Alarm mutable: No
Definition: The controller subsystem sends life-ticks at regular intervals to the UI. If they are interrupted for more than a prescribed time it is assumed that the controller sub-system is not functioning properly and the "Controller system error. Restart ventilator." alarm is generated. Any system error message received from the controller will also activate this alarm.	
Ventilator action: The ventilator will display this alarm message.	
User action: Step 1. Manually ventilate the patient. Step 2. Record the ventilator settings. Step 3. Enter Standby mode and then restart the ventilator. Step 4. Re-enter the mode of ventilation and reset the ventilator settings recorded prior to restart.	
WARNING: If at this point the alarm message "Controller system error. Restart ventilator" re-appears transfer the patient to an alternative form of ventilation. Withdraw ventilator from use. Route ventilator for repair.	
Step 5. If required re-calibrate the flow sensor. Step 6. If required turn on etCO₂ / SpO₂ monitoring. Step 7. Reconnect the patient to the ventilator. Step 8. Adjust ventilation parameters if required.	

Alarm message: No Gas	
Alarm condition: Gas not connected	Alarm type: Technical
Active in all modes	Alarm ranking: 10
Alarm type: Visual and audible	Alarm priority: High
Latching: No	Alarm mutable: No
Definition: This alarm is generated by the controller subsystem indicating that both air and oxygen supplies have dropped below 2 bar.	
Ventilator action: The ventilator will display this alarm message.	
User action: Transfer the patient to an alternative form of ventilation.	

Alarm message: Continuing Positive Pressure	
Alarm condition: Continuing Pressure	Alarm type: Patient
Active in all modes except O2 therapy	Alarm ranking: 11
Alarm type: Visual and audible	Alarm priority: High
Latching: No	Alarm mutable: Yes
Definition: If the pressure remains more than 5mBar above the user set CPAP level for 4 seconds this alarm is generated. In pure HFO mode this alarm is generated when the measured mean is more than 15mbar above the captured mean or 15mbar above the received alarm threshold.	
Ventilator action: In conventional modes, if the pressure rises more than 5mbar above the user set pressure or the continuing positive pressure condition is recognised then the monitor will raise an alarm and instruct the controller to stop ventilation. If this fails the monitor subsystem intervenes and stops ventilation.	
User action: Check Patient. Check Patient circuit. If alarm persists transfer the patient to an alternative form of ventilation. Withdraw ventilator from use. Route ventilator for repair.	

Alarm message: High Pressure Threshold Exceeded.	
Alarm condition: High pressure	Alarm type: Patient
Active in all modes except O2 therapy	Alarm ranking: 12
Alarm type: Visual and audible	Alarm priority: High
Latching: Yes	Alarm mutable: Yes
Definition: In conventional modes, if the maximum pressure rises more than 5mbar above the high PIP pressure threshold the monitor will raise an alarm and instruct the controller to stop ventilation. If this fails the monitor subsystem intervenes and stops ventilation.	
Ventilator action: If the pressure is 5mbar above the High PIP threshold a command is sent to the controller to cut the gas but maintain the CPAP/PEEP/Mean. If the pressure goes 20 mbar above the High PIP threshold the monitor should cut the all the gas off.	
User action: Check Patient. Check Patient circuit. Adjust ventilatory parameters or High PIP threshold.	

Alarm message: High Paw	
Alarm condition: High Paw	Alarm type: Patient
Active in HFO, HFO+CMV & NHFOV only.	Alarm ranking: 13
Alarm type: Visual and audible	Alarm priority: High
Latching: Yes	Alarm mutable: Yes
Definition: Proximal pressure has gone above the High Paw alarm threshold by no more than 5 mbar.	
Ventilator action: The ventilator will display this alarm message.	
User action: Check Patient. Check Patient circuit. Adjust ventilatory parameters or High Paw threshold.	

Alarm message: High PIP	
Alarm condition: High PIP	Alarm type: Patient
Active in all modes except HFO, NHFOV and O2 therapy.	Alarm ranking: 14
Alarm type: Visual and audible	Alarm priority: High
Latching: Yes	Alarm mutable: Yes
Definition: Proximal pressure has gone above the High PIP alarm threshold by no more than 5 mbar.	
Ventilator action: The ventilator will display this alarm message.	
User action: Check Patient. Check Patient circuit. Adjust ventilatory parameters or High PIP threshold.	

Alarm message: High CPAP	
Alarm condition: High CPAP	Alarm type: Patient
Active in CPAP mode only	Alarm ranking: 15
Alarm type: Visual and audible	Alarm priority: High
Latching: Yes	Alarm mutable: Yes
Definition: Proximal pressure has gone above the High CPAP alarm threshold.	
Ventilator action: The ventilator will display this alarm message.	
User action: Check Patient. Check Patient circuit. Adjust ventilatory parameters or High CPAP threshold.	

Alarm message: Low PIP	
Alarm condition: Low PIP	Alarm type: Patient
Active in all modes except HFO, NHFOV and O2 therapy	Alarm ranking: 16
Alarm type: Visual and audible	Alarm priority: High
Latching: Yes	Alarm mutable: Yes
<p>Definition:</p> <p>For CPAP, CMV, PSV, PTV & SIMV</p> <p>1. Proximal pressure has to rise from below to the above of Low PIP alarm threshold during inspiration period and it has to remain above the threshold for set the inspiration period.</p> <p>For NIPPV and NIPPVtr</p> <p>1. The Low PIP alarm is disabled if the difference between the PIP and PEEP are set to 6mbar or less.</p> <p>2. If the difference between the PIP and PEEP is more than 6 mbar then the following applies</p> <p>a. If RR is 50 BPM or more the alarm would sound after 5 ventilator cycle.</p> <p>b. If RR is less than 50 BPM the alarm would sound after 2 ventilator cycle.</p>	
Ventilator action: The ventilator will display this alarm message.	
User action: Check Patient. Check Patient circuit. Adjust ventilatory parameters or Low PIP threshold.	

Alarm message: Low Pressure	
Alarm condition: Low pressure	Alarm type: Patient
Active in all modes	Alarm ranking: 17
Alarm type: Visual and audible	Alarm priority: High
Latching: Yes	Alarm mutable: Yes
Definition: If the proximal pressure is below the Low PEEP pressure level this alarm is generated	
Ventilator action: If the proximal pressure is below the set Low PEEP pressure level the ventilator will display this alarm message. If the mean pressure drops below zero then the monitor will instruct the controller to stop ventilation. If this fails the monitor subsystem intervenes and stops ventilation.	
User action: Check Patient. Check Patient circuit. Adjust ventilatory parameters or Low PEEP threshold.	

Alarm message: Pressure change detected.	
Alarm condition: Pressure MAX Change	Alarm type: Patient
Active in HFO+CMV only	Alarm ranking: 18
Alarm type: Visual and audible	Alarm priority: High
Latching: Yes	Alarm mutable: Yes
<p>Definition: Upon a change in the ventilator setting the maximum and minimum pressure during inspiratory and expiratory phase is captured.</p> <p>For this alarm to trigger the following conditions must be true:</p> <p>Condition 1:</p> <p>1-The captured expiratory maximum pressure must be less than 10mBar</p> <p>2-The maximum pressure during the inspiration phase differs from the captured value by more than 5mBar.</p> <p>Condition 2:</p> <p>2-The maximum pressure during the expiration phase differs from the captured value by more than 5mBar.</p>	
Ventilator action: If the conditions for scenario 1 or 2 are met the ventilator will display this alarm message.	
User action: User action: Check Patient. Check Patient circuit. Adjust ventilatory parameters or press Auto Set.	

Alarm message: Cycle Fail.	
Alarm condition: Fail to cycle	Alarm type: Patient
Active in all volume modes.	Alarm ranking: 19
Alarm type: Visual and audible	Alarm priority: High
Latching: No	Alarm mutable: Yes
Definition: If Targeted volume is active this alarm would be generated if 2 consecutive breaths show a PEEP and PIP of < 3mbars.	
Ventilator action: The ventilator will display this alarm message.	
User action: Check Patient. Check Patient circuit. Adjust ventilatory parameters.	

Alarm message: Pressure sensor fault. Remove ventilator from use.	
Alarm condition: Pressure drift	Alarm type: Patient
Active in all modes except O2 therapy	Alarm ranking: 20
Alarm type: Visual and audible	Alarm priority: High
Latching: No	Alarm mutable: Yes
Definition: If the readings from the two input pressure transducers differ by more than 5 mbar for more than 0.5 seconds this alarm is generated.	
Ventilator action: The ventilator will display this alarm message.	
User action: Transfer the patient to an alternative form of ventilation. Withdraw ventilator from use. Route ventilator for repair.	

Alarm message: High PEEP	
Alarm condition: PEEP too high	Alarm type: Patient
Active in all modes except HFO, NHFOV and O2 therapy	Alarm ranking: 21
Alarm type: Visual and audible	Alarm priority: High
Latching: No	Alarm mutable: Yes
Definition: Proximal pressure has gone above the High PEEP alarm threshold during the expiratory cycle.	
Ventilator action: The ventilator will display this alarm message.	
User action: Check Patient. Check Patient circuit. Adjust ventilatory parameters.	

Alarm message: Unexpected Rise in Mean Pressure	
Alarm condition: Mean Pressure High	Alarm type: Patient
Active in HFO and NHFO only	Alarm ranking: 22
Alarm type: Visual and audible	Alarm priority: High
Latching: No	Alarm mutable: Yes
Definition: If the mean proximal pressure is above the set mean pressure by more than 5 mbar this alarm is generated.	
Ventilator action: The ventilator will display this alarm message.	
User action: Check Patient. Check Patient circuit. Adjust ventilatory parameters.	

Alarm message: Unexpected Drop in Mean Pressure	
Alarm condition: Mean Pressure Low	Alarm type: Patient
Active in HFO and NHFO only	Alarm ranking: 23
Alarm type: Visual and audible	Alarm priority: High
Latching: No	Alarm mutable: Yes
Definition: If the mean proximal pressure is below the set mean pressure by more than 5 mbar this alarm is generated.	
Ventilator action: The ventilator will display this alarm message.	
User action: Check Patient. Check Patient circuit. Adjust ventilatory parameters.	

Alarm message: Unexpected Rise in Delta Pressure	
Alarm condition: Delta Pressure Rise	Alarm type: Patient
Active in HFO and NHFO only	Alarm ranking: 24
Alarm type: Visual and audible	Alarm priority: High
Latching: No	Alarm mutable: Yes
Definition: If the minimum and maximum of the proximal pressure increases/ decreases by more than 5 mbar compared to the captured value this alarm is raised	
Ventilator action: The ventilator will display this alarm message.	
User action: Check Patient. Check Patient circuit. Adjust ventilatory parameters.	

Alarm message: Unexpected Drop in Delta Pressure	
Alarm condition: Delta Pressure Drop	Alarm type: Patient
Active in HFO and NHFO only	Alarm ranking: 25
Alarm type: Visual and audible	Alarm priority: High
Latching: No	Alarm mutable: Yes
Definition: If the proximal pressure decreases by more than 5 mbar compared to the captured value this alarm is raised	
Ventilator action: The ventilator will display this alarm message.	
User action: Check Patient. Check Patient circuit. Adjust ventilatory parameters.	

Alarm message ranked 26 is no longer used in this version of software

Alarm message: No O2 Supply	
Alarm condition: O2 not connected	Alarm type: Technical
Active in all modes	Alarm ranking: 27
Alarm type: Visual and audible	Alarm priority: High
Latching: No	Alarm mutable: No
Definition: This alarm is generated by the controller subsystem indicating the Oxygen supply has dropped below 2 bar.	
Ventilator action: The ventilator will display this alarm message and continue to operate on the air supply.	
User action: Transfer the patient to an alternative form of ventilation.	

Alarm message: No Air Supply.	
Alarm condition: Air not connected	Alarm type: Technical
Active in all modes	Alarm ranking: 28
Alarm type: Visual and audible	Alarm priority: High
Latching: No	Alarm mutable: No
Definition: This alarm is generated by the controller subsystem indicating the Air supply has dropped below 2 bar.	
Ventilator action: The ventilator will display this alarm message and continue to operate on the oxygen supply.	
User action: Transfer the patient to an alternative form of ventilation.	

Alarm message: Monitor hardware fault. Remove ventilator from use.	
Alarm condition: ADC Voltage spec	Alarm type: Technical
Active in all modes	Alarm ranking: 29
Alarm type: Visual and audible	Alarm priority: High
Latching: No	Alarm mutable: No
Definition: This alarm is generated whenever some of the voltage rails on the monitor board are out of specification (dropped by more than 20%). The error codes can be read in from the alarm history tab (Limit field).	
See ““Monitor hardware fault” fault table” on page 221.	
2V5 REF (This message will not trigger this alarm)	
8V Standby error (This message will trigger this alarm)	
5V Sounder error (This message will trigger this alarm)	
3V3 error (This message will trigger this alarm)	
Ventilator action: The ventilator will display this alarm message.	
User action: Transfer the patient to an alternative form of ventilation. Withdraw ventilator from use. Route ventilator for repair.	

Alarm message: Battery fault. Remove ventilator from use.	
Alarm condition: Power Supply battery integrity	Alarm type: Technical
Active in all modes	Alarm ranking: 30
Alarm type: Visual and audible	Alarm priority: High
Latching: No	Alarm mutable: No
Definition: If the battery is not connected or faulty this alarm is generated	
Ventilator action: The ventilator will display this alarm message. In the event of a mains power fail condition the ventilator will shut down but will provide a flow of fresh gas to assist with spontaneous breathing (1.8 l/ min).	
User action: Transfer the patient to an alternative form of ventilation. Withdraw ventilator from use. Route ventilator for repair.	

Alarm message: Battery low.	
Alarm condition: Power supply less than 10 minutes left to full discharge	Alarm type: Technical
Active in all modes	Alarm ranking: 31
Alarm type: Visual and audible	Alarm priority: High
Latching: No	Alarm mutable: No
Definition: This alarm is generated if there is less than 10 minutes to full battery exhaustion.	
Ventilator action: The ventilator will display this alarm message and continue to operate.	
User action: Transfer the patient to an alternative form of ventilation.	

Alarm message: Battery low.	
Alarm condition: Power supply battery low	Alarm type: Technical
Active in all modes	Alarm ranking: 32
Alarm type: Visual and audible	Alarm priority: Medium
Latching: No	Alarm mutable: Yes
Definition: This alarm is generated if there is less than 25% capacity.	
Ventilator action: The ventilator will display this alarm message and continue to operate.	
User action: Transfer the patient to an alternative form of ventilation.	

Alarm message: Blocked Fresh Gas. Check patient circuit.	
Alarm condition: Block alarm	Alarm type: Patient
Active in all modes	Alarm ranking: 33
Alarm type: Visual and audible	Alarm priority: High
Latching: No, except in O2 therapy	Alarm mutable: No
Definition: This alarm is generated by the controller subsystem indicating that the fresh gas limb of the patient circuit is blocked.	
Ventilator action: The fresh gas pressure is constantly monitored by the controller sub system. This pressure reading is also continually requested by the monitoring subsystem.	
User action: Check Patient circuit.	

Alarm message: Leaking Fresh Gas. Check patient circuit.	
Alarm condition: Leak alarm	Alarm type: Patient
Active in all modes	Alarm ranking: 34
Alarm type: Visual and audible	Alarm priority: High
Latching: No	Alarm mutable: No
Definition: This alarm is generated by the controller subsystem indicating that the fresh gas limb of the patient circuit is leaking.	
Ventilator action: The ventilator will display this alarm message but attainable PEEP and PIP pressures will be reduced.	
User action: Check Patient circuit.	

Alarm message: Monitor isolated communication error. Restart ventilator.	
Alarm condition: Serial communication error	Alarm type: Technical
Active in all modes with a flow sensor connected	Alarm ranking: 35
Alarm type: Visual and audible	Alarm priority: High
Latching: No	Alarm mutable: No
Definition: The internal communication error has occurred within the monitor subsystem.	
Ventilator action: The ventilator will display this alarm message.	
User action: Step 1. Manually ventilate the patient. Step 2. Record the ventilator settings. Step 3. Enter Standby mode and then restart the ventilator. Step 4. Re-enter the mode of ventilation and reset the ventilator settings recorded prior to restart.	
WARNING: If at this point the alarm message “Monitor isolated communication error. Restart ventilator.” re-appears transfer the patient to an alternative form of ventilation. Withdraw ventilator from use. Route ventilator for repair.	
Step 5. If required re-calibrate the flow sensor. Step 6. If required turn on etCO₂ / SpO₂ monitoring. Step 7. Reconnect the patient to the ventilator. Step 8. Adjust ventilation parameters if required.	

Alarm message: Monitor isolated system error. Restart ventilator.	
Alarm condition: Isolate system error	Alarm type: Technical
Active in all modes with a flow sensor connected	Alarm ranking: 36
Alarm type: Visual and audible	Alarm priority: High
Latching: No	Alarm mutable: No
Definition: If the configuration data within the isolated side of the monitor subsystem is corrupted this alarm is generated.	
Ventilator action: The ventilator will display this alarm message.	
User action: Step 1. Manually ventilate the patient. Step 2. Record the ventilator settings. Step 3. Enter Standby mode and then restart the ventilator. Step 4. Re-enter the mode of ventilation and reset the ventilator settings recorded prior to restart.	
WARNING: If at this point the alarm message “Monitor isolated system error. Restart ventilator.” re-appears transfer the patient to an alternative form of ventilation. Withdraw ventilator from use. Route ventilator for repair.	
Step 5. If required re-calibrate the flow sensor. Step 6. If required turn on etCO₂ / SpO₂ monitoring. Step 7. Reconnect the patient to the ventilator. Step 8. Adjust ventilation parameters if required.	

Alarm message: Unable to calibrate flow ADC.	
Alarm condition: Flow ADC unable to calibrate	Alarm type: Technical
Active in all modes with a flow sensor connected	Alarm ranking: 37
Alarm type: Visual and audible	Alarm priority: High
Latching: No	Alarm mutable: No
Definition: During monitor subsystem flow calibration, if the signal levels are out of bounds this alarm is generated.	
Ventilator action: The ventilator will display this alarm message.	
User action: Transfer the patient to an alternative form of ventilation. Withdraw ventilator from use.	

Alarm message: Flow sensor is defective.	
Alarm condition: Flow sensor defect	Alarm type: Technical
Active in all modes with a flow sensor connected	Alarm ranking: 38
Alarm type: Visual and audible	Alarm priority: Medium
Latching: No	Alarm mutable: Yes
Definition: If one of the flow sensor wires break this alarm is generated.	
Ventilator action: The ventilator will display this alarm message.	
User action: Replace flow sensor or the user can continue to use the ventilator in pressure mode by disconnecting the flow sensor and continuing without flow. The TTV control, Flow and volume waveforms and measurements will no longer be present on the screen.	

Alarm message: Flow sensor is contaminated.	
Alarm condition: Flow sensor is contaminated.	Alarm type: Technical
Active in all modes with a flow sensor connected	Alarm ranking: 39
Alarm type: Visual and audible	Alarm priority: Medium
Latching: No	Alarm mutable: Yes
Definition: If the measured flow is greater than 15 l/min for 3.5 seconds this alarm is generated	
Ventilator action: The ventilator will display this alarm message.	
User action: Replace flow sensor or the user can continue to use the ventilator in pressure mode by disconnecting the flow sensor and continuing with out flow. The TTV control, Flow and volume waveforms and measurements will no longer be present on the screen.	

Alarm message: Flow sensor is not connected.	
Alarm condition: Flow sensor not connected.	Alarm type: Technical
Active in all modes with a flow sensor connected	Alarm ranking: 40
Alarm type: Visual and audible	Alarm priority: Medium
Latching: No	Alarm mutable: Yes
Definition: If the flow sensor is not connected or both wires have been broken this alarm is generated.	
Ventilator action: The ventilator will display this alarm message.	
User action: Replace flow sensor or the user can continue to use the ventilator in pressure mode by disconnecting the flow sensor and continuing with out flow. The TTV control, Flow and volume waveforms and measurements will no longer be present on the screen.	

Alarm message: Unable to calibrate flow sensor.	
Alarm condition: Unable to calibrate flow sensor	Alarm type: Technical
Active in all modes with a flow sensor connected	Alarm ranking: 41
Alarm type: Visual and audible	Alarm priority: Medium
Latching: No	Alarm mutable: Yes
Definition: If calibrating flow fails for any reason this alarm is generated.	
Ventilator action: The ventilator will display this alarm message.	
User action: Replace flow sensor or the user can continue to use the ventilator in pressure mode by disconnecting the flow sensor and continuing with out flow. The TTV control, Flow and volume waveforms and measurements will no longer be present on the screen. If alarm repeats transfer the patient to an alternative form of ventilation. Withdraw ventilator from use. Route ventilator for repair.	

Alarm message: Calibrate Flow Sensor.	
Alarm condition: Flow sensor not calibrated	Alarm type: Technical
Active in all modes with a flow sensor connected	Alarm ranking: 42
Alarm type: Visual and audible	Alarm priority: High
Latching: No	Alarm mutable: Yes
Definition: The above alarm is generated whenever the ventilator is turned on or upon the re-connection of the flow sensor.	
Ventilator action: The ventilator will display this alarm message.	
User action: Calibrate the flow sensor.	

Alarm message: Flow Sensor Reversed.	
Alarm condition: Flow Sensor Reversed	Alarm type: Technical
Active in all modes with a flow sensor connected except HFO	Alarm ranking: 43
Alarm type: Visual and audible	Alarm priority: Medium
Latching: No	Alarm mutable: Yes
Definition: If the flow sensor is placed incorrectly in the circuit or the connecting wire is placed 180 degrees out of phase to where it should go this alarm is generated.	
Ventilator action: The ventilator will display this alarm message.	
User action: Re-fit flow sensor	

Alarm message: Flow Sensor Clipping	
Alarm condition: Flow sensor clipped	Alarm type: Technical
Active in all modes with a flow sensor connected except HFO	Alarm ranking: 44
Alarm type: Visual and audible	Alarm priority: High
Latching: No	Alarm mutable: Yes
Definition: If the flow through the flow sensor is greater than 30LPM for several breaths this alarm is generated.	
Ventilator action: The ventilator will display this alarm message.	
User action: Check Patient. Check Patient circuit. Adjust ventilatory parameters.	

Alarm message: User interface has reset. Check Ventilator settings.

Alarm condition: The user interface has been reset	Alarm type: Technical
Active in all modes	Alarm ranking: 45
Alarm type: Visual and audible	Alarm priority: High
Latching: No	Alarm mutable: No
Definition: If the user interface subsystem resets this alarm is generated.	
Ventilator action: The ventilator will display this alarm message.	
User action: Step 1. Check the ventilator settings. Step 2. Press reset to clear alarm message.	
WARNING: If the alarm re-appears transfer the patient to an alternative form of ventilation. Withdraw ventilator from use. Route ventilator for repair.	

Alarm message: High Minute Volume

Alarm condition: High minute volume	Alarm type: Patient
Active in all modes with a flow sensor connected except HFO+CMV. Not available in non-invasive modes and O2 therapy.	Alarm ranking: 46
Alarm type: Visual and audible	Alarm priority: High
Latching: No	Alarm mutable: Yes
Definition: If the minute volume is higher than the user set high minute volume threshold this alarm is generated	
Ventilator action: The ventilator will display this alarm message.	
User action: Check Patient. Check Patient circuit. Adjust alarm threshold.	

Alarm message: High Patient Leak.

Alarm condition: Leak	Alarm type: Patient
Active in all modes with a flow sensor connected except HFO+CMV, non-invasive modes and O2 therapy.	Alarm ranking: 47
Alarm type: Visual and audible	Alarm priority: High
Latching: No	Alarm mutable: Yes
Definition: If the calculated patient leak is above the user set alarm threshold this alarm is generated	
Ventilator action: The ventilator will display this alarm message.	
User action: Check Patient. Check Patient circuit. Adjust alarm threshold.	

Alarm message: Low Tidal volume

Alarm condition: Low tidal volume	Alarm type: Patient
Active in all modes with a flow sensor connected except non-invasive modes and O2 therapy.	Alarm ranking: 48
Alarm type: Visual and audible	Alarm priority: High
Latching: No	Alarm mutable: Yes
Definition: Tidal volumes lower than the user selected threshold would generate this alarm.	
Ventilator action: The ventilator will display this alarm message.	
User action: Check Patient. Check Patient circuit. Adjust alarm threshold.	

Alarm message: High Tidal volume	
Alarm condition: High tidal volume	Alarm type: Patient
Active in all modes with a flow sensor connected except non-invasive modes and O2 therapy.	Alarm ranking: 49
Alarm type: Visual and audible	Alarm priority: High
Latching: No	Alarm mutable: Yes
Definition: Tidal volumes higher than the user selected threshold would generate this alarm.	
Ventilator action: The ventilator will display this alarm message.	
User action: Check Patient. Check Patient circuit. Adjust alarm threshold.	

Alarm message: Low Minute Volume	
Alarm condition: Low minute volume	Alarm type: Patient
Active in all modes with a flow sensor connected except non-invasive modes and O2 therapy.	Alarm ranking: 50
Alarm type: Visual and audible	Alarm priority: High
Latching: No	Alarm mutable: Yes
Definition: If the minute volume is lower than the user-set low minute volume threshold this alarm is generated	
Ventilator action: The ventilator will display this alarm message.	
User action: Check Patient. Check Patient circuit. Adjust alarm threshold.	

Alarm message: Breath Not Detected.	
Alarm condition: Apnoea Breath	Alarm type: Patient
Active in all modes with a flow sensor connected except non-invasive modes and O2 therapy.	Alarm ranking: 51
Alarm type: Visual and audible	Alarm priority: High
Latching: No	Alarm mutable: Yes
Definition: If a breath is not detected within 20 seconds after the ventilator delivers a pressure cycle this alarm will be generated	
Ventilator action: The ventilator will display this alarm message.	
User action: Check Patient. Check Patient circuit. Adjust alarm threshold.	

Alarm message: Apnoea	
Alarm condition: Apnoea volume	Alarm type: Patient
Active in all modes with a flow sensor connected except non-invasive modes and O2 therapy.	Alarm ranking: 52
Alarm type: Visual and audible	Alarm priority: High
Latching: No	Alarm mutable: Yes
Definition: If a flow trigger is not detected within the user set apnoea time this alarm is generated	
Ventilator action: The ventilator will display this alarm message.	
User action: Check Patient. Check Patient circuit. Adjust alarm threshold.	

Alarm message: Apnoea	
Alarm condition: Apnoea pressure	Alarm type: Patient
Active in all modes without a flow sensor connected.	Alarm ranking: 53
Alarm type: Visual and audible	Alarm priority: High
Latching: No	Alarm mutable: Yes
Definition: If a pressure trigger is not detected within the user set apnoea time this alarm is generated.	
Ventilator action: The ventilator will display this alarm message.	
User action: Check Patient. Check Patient circuit. Adjust alarm threshold.	

Alarm message: High Respiratory Rate.	
Alarm condition: High BPM	Alarm type: Patient
Active in invasive CPAP, PTV, PSV, SIMV and non invasive NCPAP dual and single limb. Not available in O2 therapy.	Alarm ranking: 54
Alarm type: Visual and audible	Alarm priority: High
Latching: No	Alarm mutable: Yes
Definition: This alarm is generated when the measured total BPM (RR) is more than the user set threshold.	
Ventilator action: The ventilator will display this alarm message.	
User action: Check Patient. Check Patient circuit. Adjust alarm threshold.	

Alarm message: Main Power Fail.	
Alarm condition: Mains failure	Alarm type: Technical
Active in all modes	Alarm ranking: 55
Alarm type: Visual and audible	Alarm priority: Low
Latching: No	Alarm mutable: Yes
Definition: This alarm is generated when the mains voltage is removed from the ventilator.	
Ventilator action: The ventilator will display this alarm message and switches to the internal power source.	
User action: Restore mains power. Transfer the patient to an alternative form of ventilation.	

Alarm message: O2 sensor disconnected. Please reconnect.	
Alarm condition: Oxygen cell not connected	Alarm type: Technical
Active in all modes	Alarm ranking: 56
Alarm type: Visual and audible	Alarm priority: Medium
Latching: No	Alarm mutable: Yes
Definition: A disconnection of the oxygen cell will generate this alarm.	
Ventilator action: The ventilator will display this alarm message.	
User action: Transfer the patient to an alternative form of ventilation. Withdraw ventilator from use. Route ventilator for repair.	

Alarm message: The oxygen cell needs calibrating.	
Alarm condition: Oxygen cell needs calibrating	Alarm type: Technical
Active in all modes	Alarm ranking: 57
Alarm type: Visual and audible	Alarm priority: Medium
Latching: Yes	Alarm mutable: Yes
Definition: If at any time the measured oxygen is more than 100% this alarm is generated	
Ventilator action: The ventilator will display this alarm message.	
User action: Recalibrate the Oxygen. If the message returns transfer the patient to an alternative form of ventilation. Withdraw ventilator from use. Route ventilator for repair.	

Alarm message: A new oxygen cell is required.	
Alarm condition: Oxygen cell needs replacing	Alarm type: Technical
Active in all modes	Alarm ranking: 58
Alarm type: Visual and audible	Alarm priority: Medium
Latching: No	Alarm mutable: Yes
Definition: If the oxygen cell could not be calibrated during a calibration point this alarm is generated.	
Ventilator action: The ventilator will display this alarm message.	
User action: Transfer the patient to an alternative form of ventilation. Withdraw ventilator from use. Route ventilator for cell replacement.	

Alarm message: O2 Calibration Fail	
Alarm condition: O2 Calibration fail	Alarm type: Technical
Active in all modes	Alarm ranking: 59
Alarm type: Visual and audible	Alarm priority: Medium
Latching: No	Alarm mutable: Yes
Definition: If during 100% oxygen calibration the oxygen cell fails to see 100% oxygen this alarm is generated.	
Ventilator action: The ventilator will display this alarm message.	
User action: Transfer the patient to an alternative form of ventilation. Withdraw ventilator from use.	

Alarm message: High Oxygen Level.	
Alarm condition: Oxygen too high	Alarm type: Technical
Active in all modes	Alarm ranking: 60
Alarm type: Visual and audible	Alarm priority: High
Latching: No	Alarm mutable: Yes
Definition: If the delivered oxygen is higher than the set oxygen level by more than 5% this alarm is generated.	
Ventilator action: The ventilator will display this alarm message.	
User action: Check Patient. Recalibrate the Oxygen. If the message returns transfer the patient to an alternative form of ventilation. Withdraw ventilator from use. Route ventilator for repair.	

Alarm message: Low Oxygen Level.	
Alarm condition: Oxygen too low	Alarm type: Technical
Active in all modes	Alarm ranking: 61
Alarm type: Visual and audible	Alarm priority: High
Latching: No	Alarm mutable: Yes
Definition: If the delivered oxygen is lower than the set oxygen level by more than 5% this alarm is generated.	
Ventilator action: The ventilator will display this alarm message.	
User action: Check Patient. Recalibrate the Oxygen. If the message returns transfer the patient to an alternative form of ventilation. Withdraw ventilator from use. Route ventilator for repair.	

Alarm message: O2 > N%	
Alarm condition: O2 greater then set percentage	Alarm type: Technical
Active in OxyGenie® mode only	Alarm ranking: 62
Alarm type: Visual and audible	Alarm priority: Medium
Latching: No	Alarm mutable: No
Definition: When OxyGenie® is active the user can set a delivered oxygen level above which they want to be notified, default of 60, alarm delay is the same as SpO2 alarm delay. N = User set percentage.	
Ventilator action: The ventilator will display this alarm message.	
User action: Check patient for change of underlying condition causing increased requirement for oxygen, consider adjuring ventilator parameters. Check patient circuit for leak.	

Alarm message: Internal communication fault. Remove ventilator from use.	
Alarm condition: Can Display Congestion	Alarm type: Technical
Active in all modes	Alarm ranking: 63
Alarm type: Visual and audible	Alarm priority: High
Latching: No	Alarm mutable: No
Definition: If the data cannot be sent to the user interface subsystem this alarm is generated.	
Ventilator action: The ventilator will display this alarm message.	
User action: Transfer the patient to an alternative form of ventilation. Withdraw ventilator from use.	

Alarm message: OxyGenie is not available.	
Alarm condition: PCLC failure	Alarm type: Technical
Active in all modes	Alarm ranking: 64
Alarm type: Visual and audible	Alarm priority: High
Latching: No	Alarm mutable: No
Definition: The PCLC sub-system sends life-ticks at regular intervals to the monitor. If the above life ticks are interrupted for more than a prescribed time it will be assumed that the PCLC sub-system is not functioning properly.	
Ventilator action: The ventilator will display this alarm message.	
User action: Manual titration/adjustment of oxygen is required. Route ventilator for repair when convenient	

Alarm message: Check data output.	
Alarm condition: MO hardware fault	Alarm type: Technical
Active in all modes	Alarm ranking: 65
Alarm type: Visual and audible	Alarm priority: Medium
Latching: No	Alarm mutable: No
Definition: ESMO not responding. The ESMO sub-system is to send life-ticks at regular intervals to the monitor. If the above life ticks are interrupted for more than a prescribed time it will be assumed that the ESMO sub-system is not functioning properly	
Ventilator action: The ventilator will display this alarm message. On pressing reset the alarm message becomes a status message that will remain visible whilst the ESMO is not responding.	
User action: With an external monitor device connected. Press the reset button and then check the external monitors is still receiving data. If no data is being received disconnect the monitoring device. Ventilation functionality is not affected. If the status message does not self-cancel and remains present until the patient session has ended, route ventilator for repair. Without an external monitor device connected. Press the reset button. Ventilation functionality is not affected. If the status message does not self-cancel and remains present until the patient session has ended, route ventilator for repair.	

External sensor alarms
All external sensor alarms (etCO ₂ and SpO ₂) are ranked 66 when active. See "Sensor Alarms" on page 222.

Alarm message: OxyGenie Unexpected reset	
Alarm condition: PCLC has reset	Alarm type: Technical
Active in all modes when Auto-O₂ licence is present	Alarm ranking: 67
Alarm type: Visual and audible	Alarm priority: Medium
Latching: No	Alarm mutable: Yes
Definition: The UI checks the status of the PCLC, if the PCLC resets the UI will report this, the PCLC will be in manual mode on reset	
Ventilator action: The ventilator will display this alarm message.	
User action: OxyGenie® has been set to manual due to a reset, reactivate OxyGenie® to continue automatic adjustment of O₂. Before re-initiating OxyGenie®, check that the O₂ setting reflects the patient's current clinical condition to ensure that the control algorithm responds appropriately. If the alarm persists, manual titration/adjustment of oxygen is required and route ventilator for repair when convenient	

Alarm message: Alarm system failure. Remove ventilator from use.	
Alarm condition: Alarm generator error	Alarm type: Technical
Active in all modes	Alarm ranking: 68
Alarm type: Visual and audible	Alarm priority: High
Latching: Yes	Alarm mutable: No
Definition: The ventilator will display this alarm message and sound the backup sounder. The user cannot cancel the backup sounder alarm tone. If a new alarm is generated the visual component of the alarm is cancelled only.	
Ventilator action: The ventilator will display this alarm message.	
User action: Transfer the patient to an alternative form of ventilation. Withdraw ventilator from use. Route ventilator for repair.	

Alarm message: Alarm system failure. Remove ventilator from use.	
Alarm condition: Backup sounder fault	Alarm type: Technical
Active in all modes	Alarm ranking: 69
Alarm type: Visual and audible	Alarm priority: High
Latching: Yes	Alarm mutable: No
Definition: This alarm is generated whenever the UI detects failure of the backup speaker. The alarm can be only cleared by turning the ventilator OFF.	
Ventilator action: The ventilator will display this alarm message.	
User action: Transfer the patient to an alternative form of ventilation. Withdraw ventilator from use. Route ventilator for repair.	

Alarm Sound: Total power failure	
Alarm condition: Total power failure	Alarm type: Technical
-	Alarm ranking: -
Alarm type: Audible only	Alarm priority: High
Definition: When all internal power is exhausted this alarm is sounded.	
Ventilator action: The ventilator will sound this alarm until the unit is turned off or the alarm power supply is exhausted.	
User action: Transfer the patient to an alternative form of ventilation.	

31.4 "Power supply fault" fault table

Displayed alarm N°	One or both batteries are not of the correct type	One or both batteries are under 14.6V.	The batteries are imbalanced	One or both batteries are faulty.	Incorrect PSU type	A fault code has been returned by the PSU
1						X
2					X	
3					X	X
4				X		
5				X		X
6				X	X	
7				X	X	X
8			X			
9			X			X
10			X		X	
11			X		X	X
12			X	X		
13			X	X		X
14			X	X	X	
15			X	X	X	X
16		X				
17	X					X
18	X				X	
19		X			X	X
20		X		X		
21		X		X		X
22		X		X	X	
23		X		X	X	X
24		X	X			
25		X	X			X
26		X	X		X	
27		X	X		X	X
28		X	X	X		
29		X	X	X		X
30		X	X	X	X	
31		X	X	X	X	X
32	X					
33	X					X
34	X				X	

Displayed alarm N°	One or both batteries are not of the correct type	One or both batteries are under 14.6V.	The batteries are imbalanced	One or both batteries are faulty.	Incorrect PSU type	A fault code has been returned by the PSU
35	X				X	X
36	X			X		
37	X			X		X
38	X			X	X	
39	X			X	X	X
40	X		X			
41	X		X			X
42	X		X		X	
43	X		X		X	X
44	X		X	X		
45	X		X	X		X
46	X		X	X	X	
47	X		X	X	X	X
48	X	X				
49	X	X				X
50	X	X			X	
51	X	X			X	X
52	X	X		X		
53	X	X		X		X
54	X	X		X	X	
55	X	X		X	X	X
56	X	X	X			
57	X	X	X			X
58	X	X	X		X	
59	X	X	X		X	X
60	X	X	X	X		
61	X	X	X	X		X
62	X	X	X	X	X	
63	X	X	X	X	X	X

31.5 “Ventilator out of calibration” fault table

Displayed alarm N°	Unable to send calibration data to the isolated side	Pressure time constant calibration values have been corrupted.	Pressure gain calibration values have been corrupted	Pressure offset calibration values have been corrupted	Oxygen calibration values have been corrupted	Flow calibration values have been corrupted
1						X
2					X	
3					X	X
4				X		
5				X		X
6				X	X	
7				X	X	X
8			X			
9			X			X
10			X		X	
11			X		X	X
12			X	X		
13			X	X		X
14			X	X	X	
15			X	X	X	X
16		X				
17	X					X
18	X				X	
19		X			X	X
20		X		X		
21		X		X		X
22		X		X	X	
23		X		X	X	X
24		X	X			
25		X	X			X
26		X	X		X	
27		X	X		X	X
28		X	X	X		
29		X	X	X		X
30		X	X	X	X	
31		X	X	X	X	X
32	X					
33	X					X

Displayed alarm N°	Unable to send calibration data to the isolated side	Pressure time constant calibration values have been corrupted.	Pressure gain calibration values have been corrupted	Pressure offset calibration values have been corrupted	Oxygen calibration values have been corrupted	Flow calibration values have been corrupted
34	X				X	
35	X				X	X
36	X			X		
37	X			X		X
38	X			X	X	
39	X			X	X	X
40	X		X			
41	X		X			X
42	X		X		X	
43	X		X		X	X
44	X		X	X		
45	X		X	X		X
46	X		X	X	X	
47	X		X	X	X	X
48	X	X				
49	X	X				X
50	X	X			X	
51	X	X			X	X
52	X	X		X		
53	X	X		X		X
54	X	X		X	X	
55	X	X		X	X	X
56	X	X	X			
57	X	X	X			X
58	X	X	X		X	
59	X	X	X		X	X
60	X	X	X	X		
61	X	X	X	X		X
62	X	X	X	X	X	
63	X	X	X	X	X	X

31.6 “Controller hardware fault” fault table

Displayed alarm N°	Controller reset	Controller not responding	Breath jet module	Blender module	Fresh gas module
1					X
2				X	
3				X	X
4			X		
5			X		X
6			X	X	
7			X	X	X
8		X			
9		X			X
10		X		X	
11		X		X	X
12		X	X		
13		X	X		X
14		X	X	X	
15		X	X	X	X
16	X				
17	X				X
18	X			X	
19	X			X	X
20	X		X		
21	X		X		X
22	X		X	X	
23	X		X	X	X
24	X	X			
25	X	X			X
26	X	X		X	
27	X	X		X	X
28	X	X	X		
29	X	X	X		X
30	X	X	X	X	
31	X	X	X	X	X

31.7 “Monitor hardware fault” fault table

Displayed alarm N°	3V3 error	8V standby error	8V standby error	VREF error
1				X
2			X	
3			X	X
4		X		
5		X		X
6		X	X	
7		X	X	X
8	X			
9	X			X
10	X		X	
11	X		X	X
12	X	X		
13	X	X		X
14	X	X	X	
15	X	X	X	X

32. Sensor Alarms

32.1 Alarm Priorities

Standard priorities for the external sensors when both etCO₂ and SpO₂ sensors are connected.

When one alarm is presented to the user (according to their respective priorities) from each external sensors. The priorities are as follows:

- Priority 1. SpO₂ system alarm
- Priority 2. SpO₂ patient alarm
- Priority 3. etCO₂ system Alarm
- Priority 4. etCO₂ patient Alarm

In general a SpO₂ alarm has a higher priority than etCO₂ alarm.

However, under the following condition the etCO₂ alarm becomes higher priority than spO₂ alarm.

- Priority 1. etCO₂ patient alarm is active
- Priority 2. SpO₂ system alarm is active
- Priority 3. etCO₂ System alarm is not active

32.1.1 Status messages

Only one status message is presented from each sensor with the following priority:

- Priority 1. SpO₂ alarm
- Priority 2. etCO₂ alarm
- Priority 3. SpO₂ status
- Priority 4. etCO₂ status

If etCO₂ alarm has a higher priority than the SpO₂ alarm then the priority would be:

- Priority 1. etCO₂ alarm
- Priority 2. SpO₂ alarm
- Priority 3. etCO₂ status
- Priority 4. SpO₂ status

32.2 SpO₂ monitoring (System alarms)

Alarm message: SpO₂/etCO₂ Hardware Fault	
Alarm condition: Communication error	Alarm type: Technical
Active in all modes: Yes when sensor connected	Alarm ranking: 1
Alarm type: Visual and audible	Alarm priority: Medium
Latching: No	Alarm mutable: Yes
Ventilator action: The ventilator will display this alarm message and show dashes in the monitored parameter display.	
User action: Remove SpO₂/etCO₂ sensors or press “Continue Without external sensors” button.	

Alarm message: No SpO₂ Module Connected	
Alarm condition: Module disconnected	Alarm type: Technical
Active in all modes: Yes when sensor connected	Alarm ranking: 2
Alarm type: Visual and audible	Alarm priority: Medium
Latching: No	Alarm mutable: Yes
Ventilator action: The ventilator will display this alarm message and show dashes in the monitored parameter display.	
User action: Connect SpO₂ sensor or turn OFF SpO₂ monitoring.	

Alarm message: SpO₂ Hardware Fault - 1	
Alarm condition: Module Fault/ Hardware failure	Alarm type: Technical
Active in all modes: Yes when sensor connected	Alarm ranking: 3
Alarm type: Visual and audible	Alarm priority: Medium
Latching: No	Alarm mutable: Yes
Ventilator action: The ventilator will display this alarm message and show dashes in the monitored parameter display.	
User action: Replace sensor cable or remove SpO₂ sensor cable and turn OFF SpO₂ monitoring or press “Continue Without SpO₂ sensor” button.	

Alarm message: SpO₂ Hardware Fault - 2	
Alarm condition: Demo Mode	Alarm type: Technical
Active in all modes: Yes when sensor connected	Alarm ranking: 4
Alarm type: Visual and audible	Alarm priority: Medium
Latching: No	Alarm mutable: Yes
Ventilator action: The ventilator will display this alarm message and show dashes in the monitored parameter display.	
User action: Replace sensor cable or remove SpO₂ sensor cable and turn OFF SpO₂ monitoring or press “Continue Without SpO₂ sensor” button.	

Alarm message: SpO2 Hardware Fault - 3	
Alarm condition: SpO2 module reset	Alarm type: Technical
Active in all modes: Yes when sensor connected	Alarm ranking: 5
Alarm type: Visual and audible	Alarm priority: Medium
Latching: No	Alarm mutable: Yes
Ventilator action: The ventilator will display this alarm message and show dashes in the monitored parameter display.	
User action: Replace sensor cable or remove SpO2 sensor cable and turn OFF SpO2 monitoring or press "Continue Without SpO2 sensor" button.	

Alarm message: No SpO2 Sensor Connected	
Alarm condition: No Sensor Connected	Alarm type: Technical
Active in all modes: Yes when sensor connected	Alarm ranking: 6
Alarm type: Visual and audible	Alarm priority: Medium
Latching: No	Alarm mutable: Yes
Ventilator action: The ventilator will display this alarm message and show dashes in the monitored parameter display.	
User action: Connect SpO2 sensor or turn OFF SpO2 monitoring.	

Alarm message: No SpO2 Cable Connected	
Alarm condition: No Cable Connected	Alarm type: Technical
Active in all modes: Yes when sensor connected	Alarm ranking: 7
Alarm type: Visual and audible	Alarm priority: Medium
Latching: No	Alarm mutable: Yes
Ventilator action: The ventilator will display this alarm message and show dashes in the monitored parameter display.	
User action: Connect SpO2 sensor or turn OFF SpO2 monitoring.	

Alarm message: No Adhesive SpO2 Sensor Connected	
Alarm condition: No Adhesive Sensor Connected	Alarm type: Technical
Active in all modes: Yes when sensor connected	Alarm ranking: 8
Alarm type: Visual and audible	Alarm priority: Medium
Latching: No	Alarm mutable: Yes
Ventilator action: The ventilator will display this alarm message and show dashes in the monitored parameter display.	
User action: Connect Adhesive SpO2 sensor or turn OFF SpO2 monitoring.	

Alarm message: Defective SpO2 Sensor - 1	
Alarm condition: Defective Sensor	Alarm type: Technical
Active in all modes: Yes when sensor connected	Alarm ranking: 9
Alarm type: Visual and audible	Alarm priority: Medium
Latching: No	Alarm mutable: Yes
Ventilator action: The ventilator will display this alarm message and show dashes in the monitored parameter display.	
User action: Replace SpO2 sensor	

Alarm message: Defective SpO2 Sensor - 2	
Alarm condition: Unrecognized sensor	Alarm type: Technical
Active in all modes: Yes when sensor connected	Alarm ranking: 10
Alarm type: Visual and audible	Alarm priority: Medium
Latching: No	Alarm mutable: Yes
Ventilator action: The ventilator will display this alarm message and show dashes in the monitored parameter display.	
User action: Replace SpO2 sensor	

Alarm message: SpO2 Sensor Off Patient	
Alarm condition: Sensor Off Patient	Alarm type: Technical
Active in all modes: Yes when sensor connected	Alarm ranking: 11
Alarm type: Visual and audible	Alarm priority: Medium
Latching: No	Alarm mutable: Yes
Ventilator action: The ventilator will display this alarm message and show dashes in the monitored parameter display.	
User action: Check sensor	

Alarm message: SpO2 Sensor Interference Detected	
Alarm condition: Interference Detected	Alarm type: Technical
Active in all modes: Yes when sensor connected	Alarm ranking: 12
Alarm type: Visual and audible	Alarm priority: Medium
Latching: No	Alarm mutable: Yes
Ventilator action: The ventilator will display this alarm message and show dashes in the monitored parameter display.	
User action: Check sensor	

Alarm message: Pulse Not Detected (SpO2)	
Alarm condition: Pulse Not Detected	Alarm type: Technical
Active in all modes: Yes when sensor connected	Alarm ranking: 14
Alarm type: Visual and audible	Alarm priority: Medium
Latching: No	Alarm mutable: Yes
Ventilator action: The ventilator will display this alarm message and show dashes in the monitored parameter display.	
User action: Check sensor	

32.3 SpO₂ monitoring (Patient alarms)

Alarm message: High SpO₂	
Alarm condition: SpO₂ High	Alarm type: Patient
Active in all modes: Yes when sensor connected	Alarm ranking: 1
Alarm type: Visual and audible	Alarm priority: Medium
Latching: No	Alarm mutable: Yes
The ventilator will display this alarm message and flash the SpO ₂ value in the monitored parameter display.	
User action: Check patient/Check ventilation parameters	

Alarm message: Low SpO₂	
Alarm condition: SpO₂ low	Alarm type: Patient
Active in all modes: Yes when sensor connected	Alarm ranking: 2
Alarm type: Visual and audible	Alarm priority: Medium
Latching: No	Alarm mutable: Yes
The ventilator will display this alarm message and flash the SpO ₂ value in the monitored parameter display.	
User action: Check patient/Check ventilation parameters	

Alarm message: High Pulse Rate	
Alarm condition: Pulse rate high	Alarm type: Patient
Active in all modes: Yes when sensor connected	Alarm ranking: 3
Alarm type: Visual and audible	Alarm priority: Medium
Latching: No	Alarm mutable: Yes
The ventilator will display this alarm message and flash the PR value in the waveform title bar.	
User action: Check patient/Check ventilation parameters	

Alarm message: Low Pulse Rate	
Alarm condition: Pulse rate low	Alarm type: Patient
Active in all modes: Yes when sensor connected	Alarm ranking: 4
Alarm type: Visual and audible	Alarm priority: Medium
Latching: No	Alarm mutable: Yes
The ventilator will display this alarm message and flash the RR value in the waveform title bar.	
User action: Check patient/Check ventilation parameters	

32.4 EtCO₂ monitoring (System alarms)

Alarm message: SpO₂/etCO₂ Hardware Fault	
Alarm condition: Communication error	Alarm type: Technical
Active in all modes: Yes when sensor connected	Alarm ranking: 1
Alarm type: Visual and audible	Alarm priority: Medium
Latching: No	Alarm mutable: Yes
Ventilator action: The ventilator will display this alarm message and show dashes in the monitored parameter display.	
User action: Remove SpO₂/etCO₂ sensors.	

Alarm message: No etCO₂ Module Connected	
Alarm condition: Module disconnection	Alarm type: Technical
Active in all modes: Yes when sensor connected	Alarm ranking: 2
Alarm type: Visual and audible	Alarm priority: Medium
Latching: No	Alarm mutable: Yes
Ventilator action: The ventilator will display this alarm message and show dashes in the monitored parameter display.	
User action: Connect etCO₂ sensor or turn OFF etCO₂ monitoring.	

Alarm message: etCO₂ Module Fault - 1	
Alarm condition: Module malfunction	Alarm type: Technical
Active in all modes: Yes when sensor connected	Alarm ranking: 3
Alarm type: Visual and audible	Alarm priority: Medium
Latching: No	Alarm mutable: Yes
Ventilator action: The ventilator will display this alarm message and show dashes in the monitored parameter display.	
User action: Replace sensor module or remove etCO₂ module and FilterLine™ and turn OFF etCO₂ monitoring or press “Continue Without etCO₂ sensor” button.	

Alarm message: etCO₂ Module Fault - 2	
Alarm condition: Invalid mode	Alarm type: Technical
Active in all modes: Yes when sensor connected	Alarm ranking: 4
Alarm type: Visual and audible	Alarm priority: Medium
Latching: No	Alarm mutable: Yes
Ventilator action: The ventilator will display this alarm message and show dashes in the monitored parameter display.	
User action: Replace sensor module or remove etCO₂ module and FilterLine™ and turn OFF etCO₂ monitoring.	

Alarm message: etCO₂ Module Fault - 3	
Alarm condition: Module reset	Alarm type: Technical
Active in all modes: Yes when sensor connected	Alarm ranking: 5
Alarm type: Visual and audible	Alarm priority: Medium
Latching: No	Alarm mutable: Yes
Ventilator action: The ventilator will display this alarm message and show dashes in the monitored parameter display.	
User action: Replace sensor module or remove etCO₂ module and FilterLine™ and turn OFF etCO₂ monitoring.	

Alarm message: No etCO₂ FilterLine connected	
Alarm condition: FilterLine™ not connected	Alarm type: Technical
Active in all modes: Yes when sensor connected	Alarm ranking: 6
Alarm type: Visual and audible	Alarm priority: Medium
Latching: No	Alarm mutable: Yes
Ventilator action: The ventilator will display this alarm message and show dashes in the monitored parameter display.	
User action: Connect FilterLine™ or turn OFF etCO₂ monitoring or press “Continue Without etCO₂ sensor” button.	

Alarm message: Replace etCO₂ FilterLine	
Alarm condition: Occlusion in gas input line	Alarm type: Technical
Active in all modes: Yes when sensor connected	Alarm ranking: 7
Alarm type: Visual and audible	Alarm priority: Medium
Latching: No	Alarm mutable: Yes
Ventilator action: The ventilator will display this alarm message and show dashes in the monitored parameter display.	
User action: Replace FilterLine™	

Alarm message: etCO₂ Module Fault - 4	
Alarm condition: Temperature out of range	Alarm type: Technical
Active in all modes: Yes when sensor connected	Alarm ranking: 8
Alarm type: Visual and audible	Alarm priority: Medium
Latching: No	Alarm mutable: Yes
Ventilator action: The ventilator will display this alarm message and show dashes in the monitored parameter display.	
User action: Replace sensor module or remove etCO₂ module and FilterLine™ and turn OFF etCO₂ monitoring or press “Continue Without etCO₂ sensor” button.	

Alarm message: etCO2 Module Fault - 5	
Alarm condition: Check Flow	Alarm type: Technical
Active in all modes: Yes when sensor connected	Alarm ranking: 9
Alarm type: Visual and audible	Alarm priority: Medium
Latching: No	Alarm mutable: Yes
Ventilator action: The ventilator will display this alarm message and show dashes in the monitored parameter display.	
User action: Replace sensor module or remove etCO2 module and FilterLine™ and turn OFF etCO2 monitoring or press “Continue Without etCO2 sensor” button.	

Alarm message: CO2 value over-range	
Alarm condition: CO2 value over-range	Alarm type: Technical
Active in all modes: Yes when sensor connected	Alarm ranking: 10
Alarm type: Visual and audible	Alarm priority: Medium
Latching: No	Alarm mutable: Yes
Ventilator action: The ventilator will display this alarm message and show dashes in the monitored parameter display.	
User action: Replace sensor module or remove etCO2 module and FilterLine™ and turn OFF etCO2 monitoring.	

Alarm message: Invalid CO2 Value	
Alarm condition: Invalid CO2 Value	Alarm type: Technical
Active in all modes: Yes when sensor connected	Alarm ranking: 11
Alarm type: Visual and audible	Alarm priority: Medium
Latching: No	Alarm mutable: Yes
Ventilator action: The ventilator will display this alarm message and show dashes in the monitored parameter display.	
User action: Replace sensor module or remove etCO2 module and FilterLine™ and turn OFF etCO2 monitoring.	

32.5 EtCO₂ monitoring (Patient alarms)

Alarm message: No etCO₂ Breath	
Alarm condition: No breath	Alarm type: Patient
Active in all modes: Yes when sensor connected	Alarm ranking: 1
Alarm type: Visual and audible	Alarm priority: High
Latching: No	Alarm mutable: Yes
Ventilator action: The ventilator will display this alarm message and show dashes in the monitored parameter display.	
User action: Check patient, Check FilterLine™. Check ventilation parameters.	

Alarm message: High etCO₂	
Alarm condition: etCO₂ High alarm	Alarm type: Patient
Active in all modes: Yes when sensor connected	Alarm ranking: 2
Alarm type: Visual and audible	Alarm priority: Medium
Latching: No	Alarm mutable: Yes
Ventilator action: The ventilator will display this alarm message and flash the etCO ₂ value in the monitored parameter display.	
User action: Check patient, Check ventilation parameters.	

Alarm message: Low etCO₂	
Alarm condition: etCO₂ Low alarm	Alarm type: Patient
Active in all modes: Yes when sensor connected	Alarm ranking: 3
Alarm type: Visual and audible	Alarm priority: Medium
Latching: No	Alarm mutable: Yes
Ventilator action: The ventilator will display this alarm message and flash the etCO ₂ value in the monitored parameter display.	
User action: Check patient, Check ventilation parameters.	

Alarm message: High CO₂	
Alarm condition: CO₂ High alarm	Alarm type: Patient
Active in all modes: Yes when sensor connected	Alarm ranking: 4
Alarm type: Visual and audible	Alarm priority: Medium
Latching: No	Alarm mutable: Yes
Ventilator action: The ventilator will display this alarm message and flash the CO ₂ value in the monitored parameter display.	
User action: Check patient, Check ventilation parameters.	

Alarm message: Low CO2	
Alarm condition: CO2 Low alarm	Alarm type: Patient
Active in all modes: Yes when sensor connected	Alarm ranking: 5
Alarm type: Visual and audible	Alarm priority: Medium
Latching: No	Alarm mutable: Yes
Ventilator action: The ventilator will display this alarm message and flash the CO2 value in the monitored parameter display.	
User action: Check patient, Check ventilation parameters.	

Alarm message: High etCO2 Spont	
Alarm condition: etCO2 Spont High alarm	Alarm type: Patient
Active in all modes: Yes when sensor connected	Alarm ranking: 6
Alarm type: Visual and audible	Alarm priority: Medium
Latching: No	Alarm mutable: Yes
Ventilator action: The ventilator will display this alarm message.	
User action: Check patient, Check ventilation parameters.	

33. Sensor Status messages

33.1 SpO₂ Status messages

Status message: Too Much Ambient Light (SpO ₂)	
Condition: Too Much Ambient Light	Message type: Technical
Active in all modes: Yes when sensor connected	Message ranking: 1
Message type: Visual	Message priority: Low
Latching: No	Message mutable: N/A
Ventilator action: The ventilator will display this message.	
User action: Check sensor and reduce ambient light	

Status message: Low Perfusion Index (SpO ₂)	
Condition: Low Perfusion Index	Message type: Technical
Active in all modes: Yes when sensor connected	Message ranking: 2
Message type: Visual	Message priority: Low
Latching: No	Message mutable: N/A
Ventilator action: The ventilator will display this message and flash the PI value in the waveform display.	
User action: Check sensor, Check patient, Check ventilation parameters.	

Status message: Pulse Search	
Condition: Pulse Search	Message type: Technical
Active in all modes: Yes when sensor connected	Message ranking: 3
Message type: Visual	Message priority: Low
Latching: No	Message mutable: N/A
Ventilator action: The ventilator will display this message and flash the SpO ₂ value in the monitored parameter display.	
User action: Check sensor, Check patient, Check ventilation parameters.	

Status message: Low SpO ₂ Signal IQ	
Condition: Low Signal IQ for more than 30 seconds	Message type: Technical
Active in all modes: Yes when sensor connected	Message ranking: 4
Alarm type: Visual	Message priority: Low
Latching: No	Message mutable: N/A
Ventilator action: The ventilator will display this message and show dashes in the monitored parameter display.	
User action: Check sensor	

33.2 EtCO₂ Status messages

Status message: etCO ₂ initializing	
Condition: Start-up	Message type: Technical
Active in all modes: Yes when sensor connected	Message ranking: 1
Message type: Visual	Message priority: Low
Latching: No	Message mutable: N/A
Ventilator action: The ventilator will display this message and show dashes in the monitored parameter display.	
User action: Allow sensor module to start.	

Status message: etCO ₂ Purge	
Condition: Purge active	Message type: Technical
Active in all modes: Yes when sensor connected	Message ranking: 2
Message type: Visual	Message priority: Low
Latching: No	Message mutable: N/A
Ventilator action: The ventilator will display this message and show dashes in the monitored parameter display.	
User action: Allow sensor to complete purge cycle.	

Status message: etCO ₂ Self Maintenance Mode	
Condition: Self maintenance mode	Message type: Technical
Active in all modes: Yes when sensor connected	Message ranking: 3
Message type: Visual	Message priority: Low
Latching: No	Message mutable: N/A
Ventilator action: The ventilator will display this message and show dashes in the monitored parameter display.	
User action: Allow sensor to complete self maintenance mode.	

Status message: etCO ₂ Pump OFF	
Condition: Pump off	Message type: Technical
Active in all modes: Yes when sensor connected	Message ranking: 4
Message type: Visual and audible	Message priority: Low
Latching: No	Message mutable: N/A
Ventilator action: The ventilator will display this message and show dashes in the monitored parameter display.	
User action: Turn pump ON if required.	

Status message: etCO ₂ Calibration Is Due	
Condition: Calibration is due	Message type: Technical
Active in all modes: Yes when sensor connected	Message ranking: 5
Message type: Visual	Message priority: Low
Latching: No	Message mutable: N/A
Ventilator action: The ventilator will display this message and show dashes in the monitored parameter display.	
User action: None.	

Status message: etCO2 Maintenance Is Due	
Condition: Maintenance is due	Message type: Technical
Active in all modes: Yes when sensor connected	Message ranking: 6
Message type: Visual	Message priority: Low
Latching: No	Message mutable: N/A
Ventilator action: The ventilator will display this message and show dashes in the monitored parameter display.	
User action: None.	

34. Cleaning and disinfection

The cleaning and disinfection instructions are for SLE6000's external surfaces and the detachable components of the SLE6000 that are required to be cleaned and disinfected after each patient use.

Note: All other accessories not listed here can be cleaned in accordance with local hospital guideline.

Note: For the etCO₂ MicroPod™ module and the uSpO₂ cable (Masimo SET®) refer to the instructions for use supplied with the respective device.

Components that can be in the gas pathway and can become contaminated are:

- Exhalation block
- Silencer
- Gas jet ports
- Occlusion valve

The ventilator's external surface includes the back surface of the ventilator, the screen, the metal plate at the bottom of the ventilator, the metal cover and the moulded case.

Detachable components are: the exhalation block and silencer.

34.1 Instructions

Before cleaning or disinfecting the exterior of the ventilator the following tasks should be performed:

- 1 Disconnect the mains cable from the mains supply.
- 2 Remove the patient circuit and bacterial filters. Discard any single use items as per appropriate hospital authority guidelines. Reusable items should be processed as per appropriate hospital authority guidelines and the manufacturers' instructions.
- 3 Disconnect the gas supplies from the wall outlets.
- 4 Disconnect the Oxygen and Air hoses from the ventilator and cap the inlet ports.
- 5 Open the side flap.

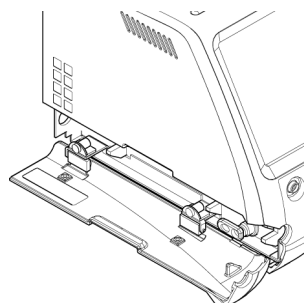

- 6 Unlock the exhalation block by turning the clamp through 90 degrees until it is horizontal.

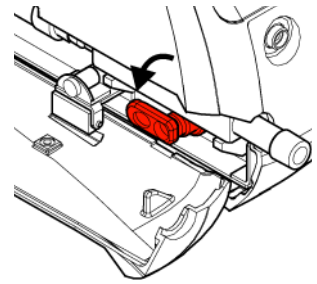

- 7 Gently pull away the exhalation block and silencer from the gas ports.

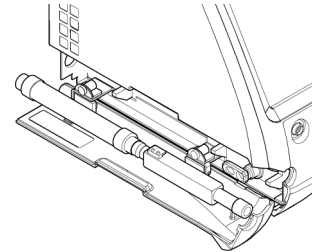

- 8 Separate the silencer and exhalation block.

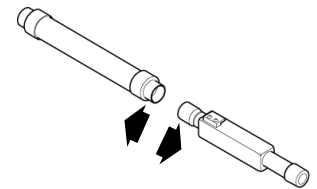

34.2 External surface cleaning instructions

- 1 Obtain three clean, disposable, absorbent non-shedding cloths.
- 2 Prepare a mild purpose detergent solution/ hand hot water in a clean container.
- 3 Wipe the ventilator' external surface using mild general purpose detergent solution/hand hot water with the first cloth.
- 4 If detergent was used for step 3, remove the detergent from the ventilator' external surface using the second cloth with water only.
- 5 Wipe the ventilator's external surface dry using the third cloth.

34.3 External surface disinfection instructions

- 1 Obtain two clean, disposable, absorbent non-shedding cloths.
 - 2 Pour Alcohol (70% isopropanol) in a container.
 - 3 Dampen one of the cloths in the Alcohol (70% isopropanol).
 - 4 Wipe the ventilator's external surface with the alcohol-wetted cloth.
 - 5 Wipe the ventilator's external surface dry using the second cloth.
- OR
- 6 Wipe the ventilator's external surface using Alcohol (70% isopropanol) wipes.
 - 7 Allow to dry.

34.4 Exhalation block cleaning instructions

Note: For use of automatic washers please follow hospital guidelines.

- 1 Prepare a mild purpose detergent solution/ hand hot water in a clean container.
- 2 Wash the exhalation block in the mild general purpose detergent solution / hand hot water.
- 3 Rinse with sterile water.
- 4 Allow to dry.
- 5 Check that the pressure relief valve ball rattle when the exhalation block is shaken. If not rewash and ensure any residue is removed that may be sticking the balls in place.

34.5 Exhalation block disinfection instructions

- 1 Pour Alcohol (70% isopropanol) in a container, enough to submerge the exhalation block in it.
- 2 Immerse the exhalation block in Alcohol (70% isopropanol) for 30seconds.
- 3 Allow to dry for an hour.
- 4 Autoclave with pure dry saturated steam at 134°C at 320kPa with a minimum holding time of 3 minutes or 121°C at 210kPa with a minimum holding time of 15 minutes.

34.6 Reusable Silencer disinfection instructions

- 1 Steam disinfect with pure dry saturated steam at 134°C at 320kPa with a minimum holding time of 3 minutes or 121°C at 210kPa with a minimum holding time of 15 minutes

Note: The silencer can be steam disinfected up to 25 times. Mark the silencer with a suitable marker after each steam disinfection cycle to indicate the number of cycles completed.

34.7 Gas jet ports disinfection

- 1 Obtain two clean, disposable, absorbent non-shedding cloths.
- 2 Pour Alcohol (70% isopropanol) in a container.
- 3 Dampen one of the cloths in the Alcohol (70% isopropanol).
- 4 Wipe the two jet ports with the alcohol-wetted cloth.
- 5 Wipe the dry using the second cloth.

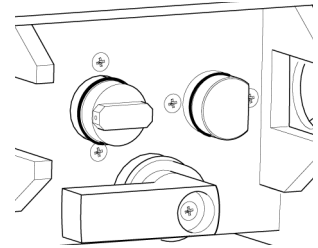

34.8 Occlusion valve

If the occlusion valve which is internally mounted is deemed to have been contaminated it can only be cleaned by a service technician as it requires ventilator disassembly.

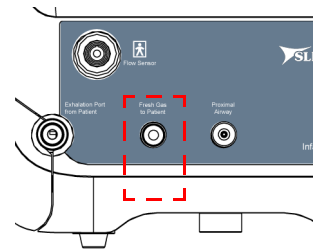

34.9 Cleaning of main air intake filter.

- 1 Remove the fan filter guard (1). No tool required.

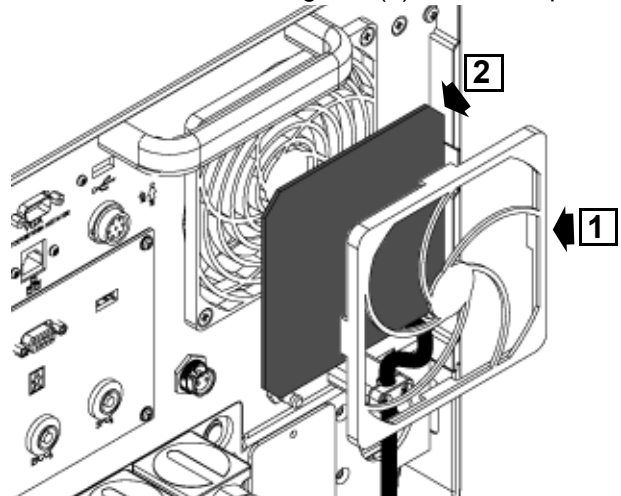

- 2 Remove the filter (2).
- 3 Wash the filter (2) in clean water.

Warning. Do not wring or deform the filter as this will cause it to loose its shape.

- 4 Dry the filter (2) between paper towels until no moisture is left.
- 5 Replace the filter (2) and filter guard (1).

35. EMC compliance

Note: The emissions characteristics of this equipment make it suitable for use in industrial areas and hospitals (CISPR 11 class A). If it is used in a residential environment (for which CISPR 11 class B is normally required) this equipment might not offer adequate protection to radio-frequency communication services. The user might need to take mitigation measures, such as relocating or re-orienting the equipment.

The SLE6000 was tested to IEC 60601-1-2:2014 complies to the following in relation to Electromagnetic disturbances with no deviations.

Based on the stated intended environment, the ventilator has been classified as Group 1, Class A.

35.1 Emissions test compliance levels

CISPR16-2-1:2008 +A1:2010 +A2:2013

Mains terminal disturbance voltages

- 240Vac at 50Hz
- 110Vac at 60Hz
- 100Vac at 60Hz

CISPR16-2-3 :2010 +A1:2010

Electromagnetic radiation disturbances - electric field

- 30 MHz to 1 GHz - Vertical - 240Vac 50Hz
- 30 MHz to 1 GHz - Horizontal - 240Vac 50Hz
- 30 MHz to 1 GHz - Vertical - 110Vac 60Hz
- 30 MHz to 1 GHz - Horizontal - 110Vac 60Hz
- 30 MHz to 1 GHz - Vertical - 100Vac 60Hz
- 30 MHz to 1 GHz - Horizontal - 100Vac 60Hz

IEC61000-3-2:2014

Harmonic current emissions

- 230Vac at 50Hz
- 110Vac at 60Hz
- 100Vac at 60Hz

IEC61000-3-3:2013

Voltage fluctuations and flicker

- 230Vac at 50Hz
- 110Vac at 50Hz
- 100Vac at 50Hz

35.2 Immunity tests compliance levels

IEC61000-4-2:2008

Electrostatic discharge

- Air discharge at 8kV and 15 kV
- Contact discharge at 8kV
- Indirect discharge at 8kV

IEC61000-4-3:2006 +A1:2007 +A2:2010

Radiated RF electromagnetic fields

- 80 - 2700 MHz in all planes

Proximity fields from RF wireless equipment

- TETRA 400 (380-390 MHz)
- GMRS 460 and FRS460 (430-470 MHz)
- LTE bands 13 and 17 (704-787 MHz)
- GSM 800/900, TETRA 800, iDEN 820, CDMA 850, LTE Band 5 (800-960 MHz)
- GSM1800, CDMA 1900, DECT, LTE Bands 1, 3, 4 & 15, UMTS (1700-1990 MHz)
- Bluetooth, WLAN 802.11b/g/n, RFID 2450, LTE Band 7 (2400-2570 MHz)
- WLAN 802.11a/n (5100-5700 MHz)

IEC61000-4-4:2012

Electrical fast transients and bursts

- 2 kV AC input 240Vac 50Hz
- 2 kV AC input 110Vac 60Hz
- 2 kV AC input 100Vac 60Hz

IEC61000-4-5:2014

Surges

- AC input 240Vac 50Hz
- AC input 110Vac 60Hz
- AC input 100Vac 60Hz

IEC61000-4-6:2013

Conducted disturbances induced by RF fields

- 3 Vrms 240Vac 50Hz
- 3 Vrms 110Vac 60Hz

IEC61000-4-8:2009

Power frequency magnetic fields

- 30 A/m 240Vac 50Hz
- 30 A/m 110Vac 60Hz

IEC61000-4-11:2004

Volt age dips and short interruptions

- AC input 240Vac 50Hz
- AC input 110Vac 60Hz
- AC input 100Vac 60Hz

35.3 Warnings - EMC

1. Use of this equipment adjacent to or stacked with other equipment should be avoided because it could result in improper operation. If such use is necessary, this equipment and the other equipment should be observed to verify that they are operating normally.
2. Use of accessories, transducers and cables other than those specified or provided by the manufacturer of this equipment could result in increased electromagnetic emissions or decreased electromagnetic immunity of this equipment and result in improper operation.
3. Portable RF communications equipment (including peripherals such as antenna cables and external antennas) should be used no closer than 30 cm (12 inches) to any part of the SLE6000, including cables specified by the manufacturer. Otherwise, degradation of the performance of this equipment could result.

35.4 Cautions - EMC

1. Only use the cables listed in chapter "Consumables & Accessories" on page 280 for connection to accessories or transducers.

36. Pneumatic unit diagram

36.1 HFO capable pneumatic unit

Below is a schematic representation of the pneumatic unit of the ventilator.

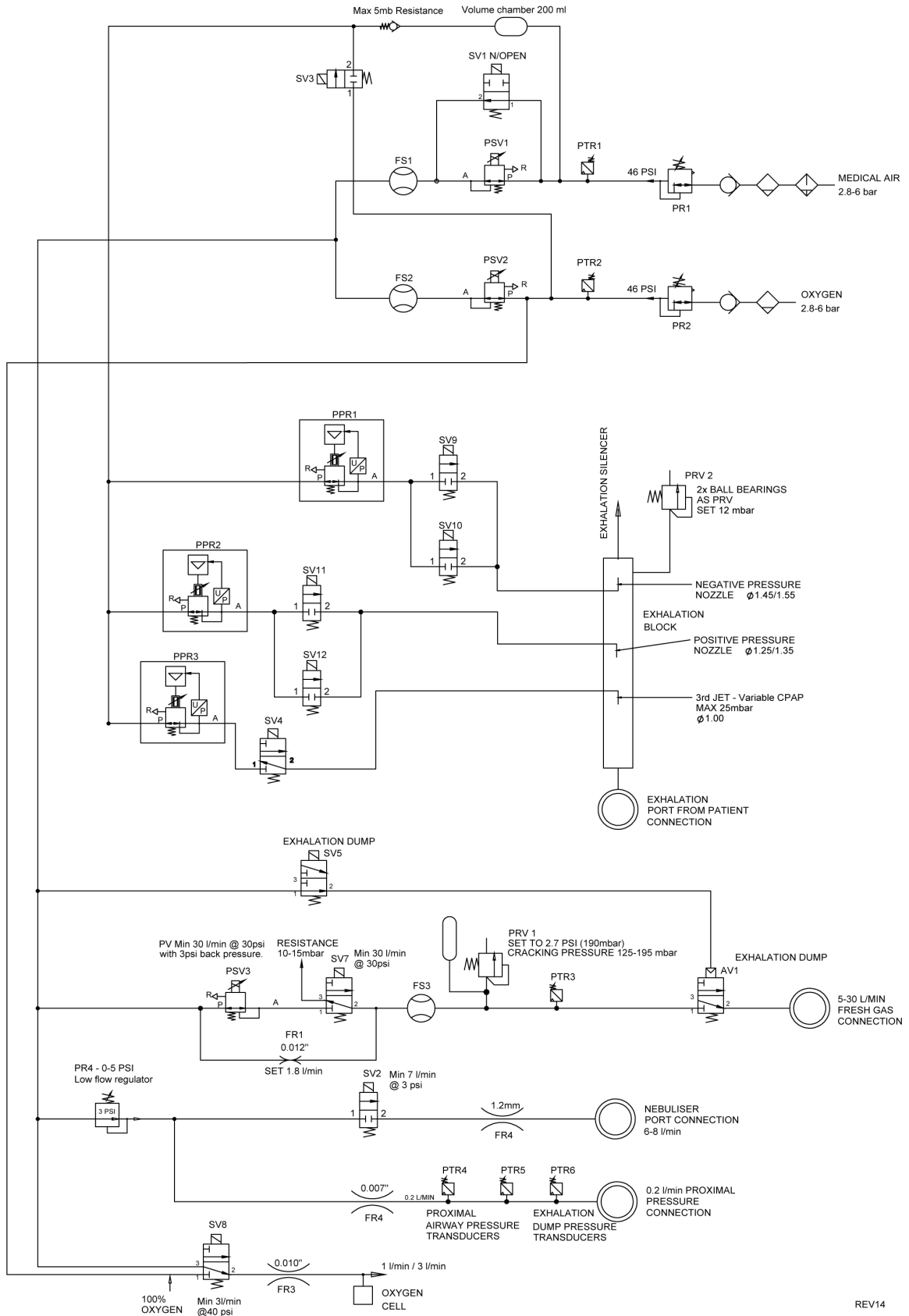

36.2 Conventional pneumatic unit

Below is a schematic representation of the pneumatic unit of the ventilator.

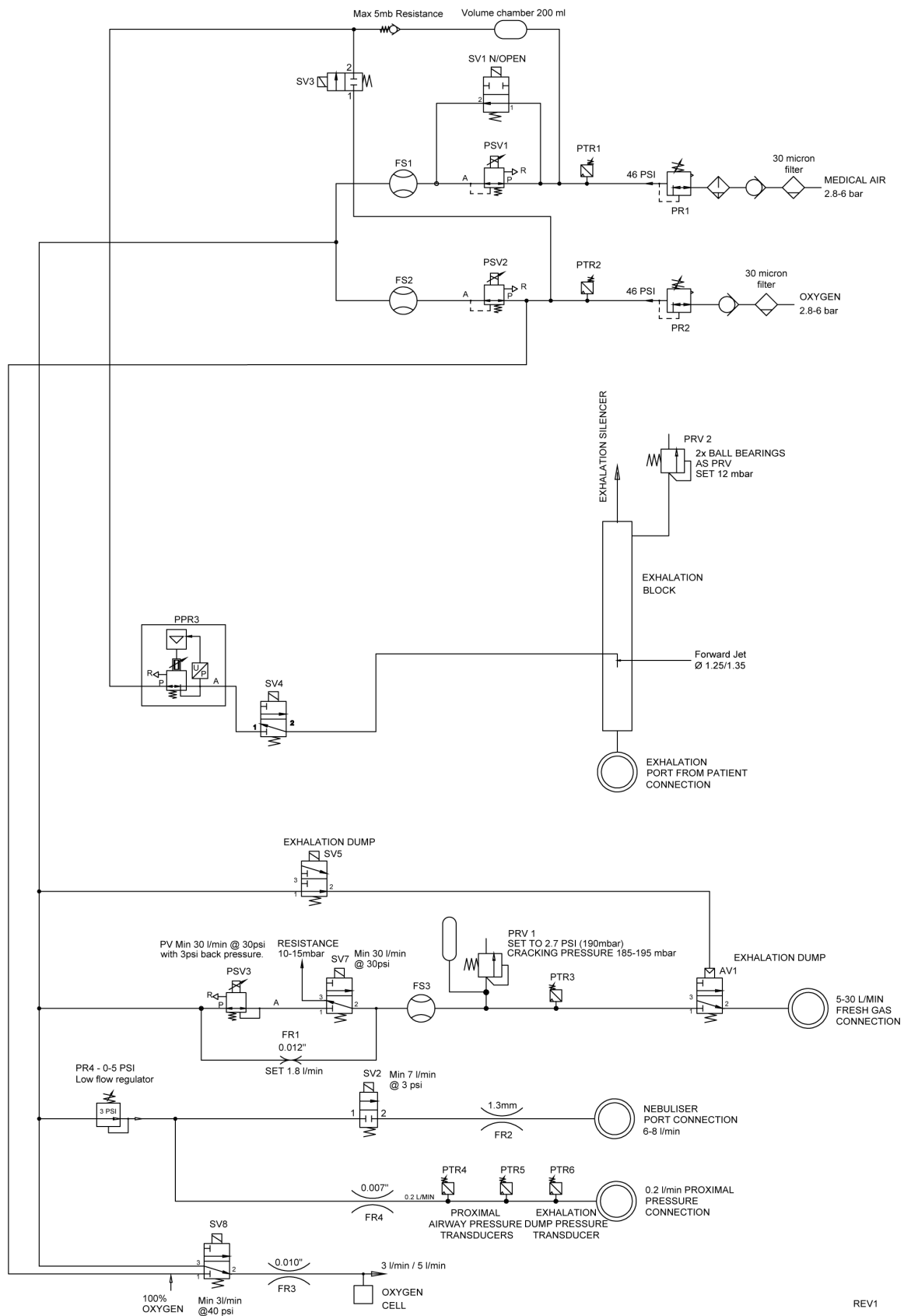

36.3 Patient circuit pneumatic diagrams

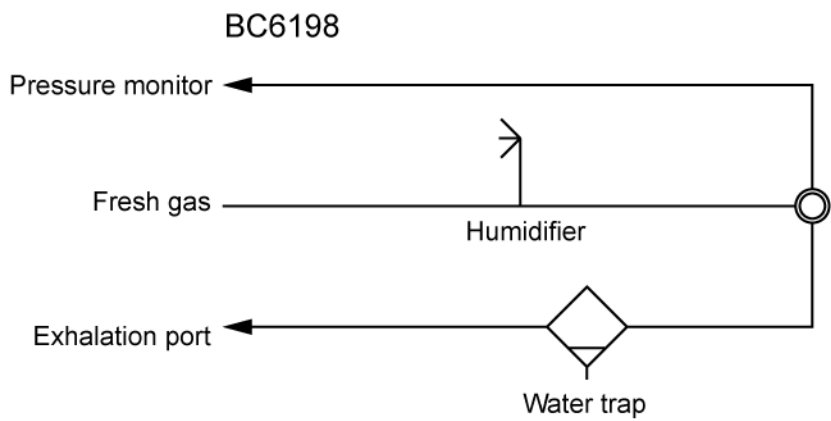
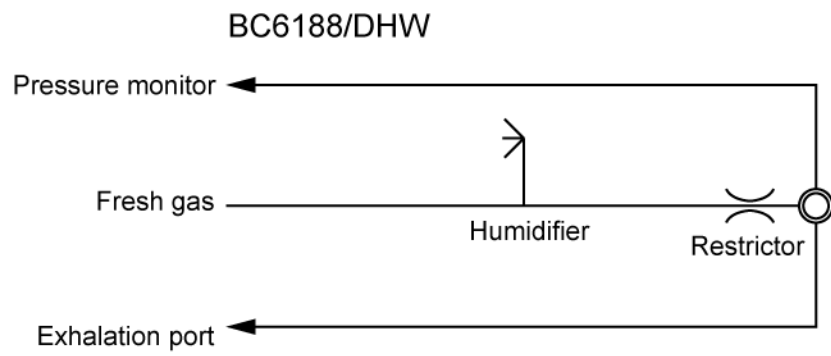
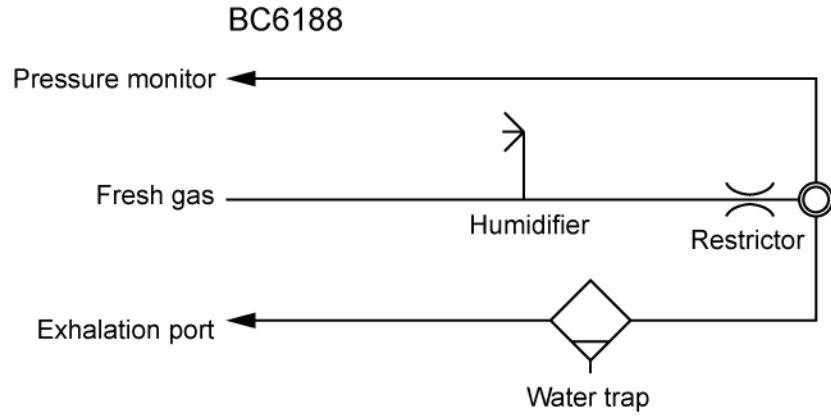

37. Software version identification

Below is a chart that allows the user to identify the software version installed on the ventilator.

System Version	V2.0.97	V2.0.98
Subsystems		
GUI software	2.0.36	2.0.36
User Preferences	2.0.14	2.0.14
UI Bios (Ventilator Serial N°: 6XX01XXXXX, 6XX02XXXXX & 6XX03XXXXX)	V3.23#4	V3.23#4
UI Bios (Ventilator Serial N°: 6XX04XXXXX)	S1.63.4.0	S1.63.4.0
MMS software	2.0.54	2.0.54
MMS hardware	2 or C5	2 or C5
PCLC software	2.0.20	2.0.20
Controller software	217	217
Controller hardware	3	3
Monitor – Isolated SW	112	112
Monitor – Non Isolated	225	225
Monitor hardware	3	3
ESMO software MO	2.0.13	2.0.13
ESMO software ES	2.0.7	2.0.7
ESMO hardware	3,4	3,4
PSU software	1.0.3	1.0.3
PSU hardware	4.1	4.1
Alarm monitor software	1.4.0	1.4.0
Alarm UI software	1.4.0	1.4.0
Languages	2.0.29	2.0.29
Operating System Version (Ventilator Serial N°: 6XX01XXXXX, 6XX02XXXXX & 6XX03XXXXX)	2.0.2	2.0.2
Operating System Version (Ventilator Serial N°: 6XX04XXXXX)	3.0.3	3.0.4
System Update	2.1.4	2.1.4
Engineering Utility	2.0.16	2.0.16
Screen Calibration Utility	1.1.1	1.1.1

Caution. If the user finds a mis-match of subsystem versions please do not use the ventilator and refer it to a qualified service technician.

Troubleshooting



38. Troubleshooting Chart

38.1 Ventilation Related Problems

Warning: In all alarm conditions check the patient first.

Symptom	Possible Cause	Remedy
Alarm Message: Blocked Fresh Gas. Check patient circuit.	Fresh gas supply tube blocked or kinked.	Check the fresh gas supply line and rest of the patient circuit. 10mm circuit fitted but ventilator invasive mode set to 15mm patient circuit.
Alarm Message: Leaking Fresh Gas. Check patient circuit.	Patient circuit leaking fresh gas.	Check the fresh gas supply line and rest of the patient circuit plus water trap. 15mm circuit fitted but ventilator invasive mode set to 10mm patient circuit.
Alarm Message: Continuing positive pressure.	Constriction of proximal airway line.	Remove constriction.
Alarm Message: High Pressure threshold exceeded.	Waveform has crossed high pressure alarm threshold.	Check ventilator pressures. Check the patient circuit.
Alarm Message: Cycle Fail.	Waveform has crossed cycle fail alarm threshold.	Check ventilator pressures. Check the patient circuit and water trap.
Alarm Message: Low Pressure.	Waveform has crossed low pressure alarm threshold.	Check ventilator pressures. Check the patient circuit and water trap. Adjust alarm threshold.
Alarm Message: Unexpected rise in mean pressure.	The mean pressure has increased by more than 5mbar.	Check ventilator pressures. Check the patient circuit. Press autoreset to for new alarm thresholds.
Alarm Message: Unexpected drop in mean pressure.	The mean pressure has decreased by more than 5mbar.	Check ventilator pressures. Check the patient circuit and water trap. Press autoreset to for new alarm thresholds.
Alarm Message: Unexpected rise in delta pressure.	The maximum pressure has increased by more than 5mbar.	Check ventilator pressures. Check the patient circuit. Press autoreset to for new alarm thresholds.

Symptom	Possible Cause	Remedy
Alarm Message: Unexpected Drop in Delta Pressure.	The maximum pressure has decreased by more than 5mbar.	Check ventilator pressures. Check the patient circuit and water trap. Press autose to for new alarm thresholds.
Alarm Message: Flow sensor is contaminated.	Flow sensor has become encrusted with secretions.	Remove sensor from patient circuit. Fit new flow sensor and calibrate. Refit sensor into patient circuit. If no replacement sensor available press "Continue without flow" and set breath trigger sensitivity.
Alarm Message: High Minute Volume.	The minute volume trend has crossed the high minute volume alarm threshold.	Check ventilator pressures. Check the patient circuit. Set new alarm threshold.
Alarm Message: Low Minute Volume.	The minute volume trend has crossed the low minute volume alarm threshold.	Check ventilator pressures. Check the patient circuit. Set new alarm threshold.
Alarm Message: High Patient Leak.	The calculated percentage of patient leak has crossed the alarm threshold.	Check the patient circuit. Set new alarm threshold.
Alarm Message: Low Tidal Volume.	The tidal volume waveform has crossed the low tidal volume alarm threshold.	Check the patient. Check the patient circuit and water trap. Set new alarm threshold.
Alarm Message: Apnoea.	A breath has not been detected by the ventilator.	Set new breath detection threshold or breath trigger sensitivity. Check the patient circuit.
Alarm Message: Breath Not Detected.	ET tube blocked or disconnected.	Check the patient for air entry. Check the patient circuit.
Preview mode cancels.	The preview mode self cancels after 120 seconds if no button presses are made.	Re-select preview mode.

38.2 Ventilator Related Problems

Warning: In all alarm conditions check the patient first.

Symptom	Possible Cause	Remedy
Ventilator screen remains blank on power up. Power button halo is green.	Display failure.	Refer ventilator to qualified service personnel.
Ventilator screen blank with alarm tone being generated. Ventilator continuing to ventilate.	Display failure.	Remove patient to alternative form of ventilation, then remove ventilator from service. Refer ventilator to qualified service personnel.
Ventilator screen blank. Power button halo is Off . Continuous alarm tone being generated.	Complete power failure.	Remove patient to alternative form of ventilation, then remove ventilator from service.
Touchscreen buttons do not operate as expected.	Touching the screen at two points. Touchscreen out of alignment.	Touch the screen at one point only Refer ventilator to qualified service personnel.
Touchscreen buttons do not operate.	Touchscreen failure.	Remove patient to alternative form of ventilation, then remove ventilator from service. Refer ventilator to qualified service personnel.
Total power fail alarm active (Audible only) after turning off the ventilator.	Power button not re-pressed on power down.	Re-press button fully to cancel alarm.
Alarm Message: No Gas.	Air and Oxygen supplies not connected to ventilator. Air and Oxygen supply failed.	Check Air and Oxygen supplies/connections. If generated whilst connected to a patient, remove patient to alternative form of ventilation.
Leaking fresh gas alarm with CPAP/PEEP/Mean at zero and PIP/Delta P at zero. Alarm Message: Leaking Fresh Gas. Check patient circuit.	Air and Oxygen supply failed.	If generated whilst connected to a patient, remove patient to alternative form of ventilation. Check Air and Oxygen supplies/connections.

Symptom	Possible Cause	Remedy
Low pressure alarm with CPAP/PEEP/Mean at zero and PIP/Delta P at zero. Alarm Message: Low Pressure.	Air and Oxygen supply failed.	If generated whilst connected to a patient, remove patient to alternative form of ventilation. Check Air and Oxygen supplies/connections.
Alarm Message: No O2 Supply.	Oxygen supply not connected to ventilator. Oxygen supply failed.	Check Oxygen supply/connections. If generated whilst connected to a patient, remove patient to alternative form of ventilation.
No Air supply alarm. Alarm Message: No Air Supply.	Air supply not connected to ventilator. Air supply failed.	Check Air supply / connections. If generated whilst connected to a patient, remove patient to alternative form of ventilation.
Battery fault alarm. Alarm Message: Battery Fault.	The internal battery has failed or the power supply has developed a fault.	Remove ventilator from service. Note alarm message and refer ventilator to qualified service personnel.
Battery Low alarm. Alarm Message: Battery Low. (Medium priority)	Battery has reached 25% charge level.	Restore mains power. If mains power cannot be restored, remove patient to alternative form of ventilation. Note alarm message and refer ventilator to qualified service personnel.
Battery Low alarm. Alarm Message: Battery Low. (High priority)	Battery has reached 10 minute operation.	Restore mains power. If mains power cannot be restored, remove patient to alternative form of ventilation. Note alarm message and refer ventilator to qualified service personnel.
Pressure sensor drift alarm. Alarm Message: Pressure sensor fault remove ventilator from use.	A pressure sensor transducer has failed an internal system check.	Remove ventilator from service. If generated whilst connected to a patient, remove patient to alternative form of ventilation Note alarm message and refer ventilator to qualified service personnel.

Symptom	Possible Cause	Remedy
Alarm Message: Faulty Flow Sensor.	A flow sensor heated wire has broken.	Remove sensor from patient circuit. Discard the flow sensor. Fit new flow sensor and recalibrate. Refit sensor into patient circuit. If no replacement sensor available press "Continue without flow" and set breath trigger sensitivity. If message continues, remove patient to alternative form of ventilation, then remove ventilator from service. Note alarm message and refer ventilator to qualified service personnel.
Alarm Message: Connect Flow Sensor.	Flow sensor cable not connected to ventilator. If sensor connected, both heated wires broken.	Connect flow sensor cable and recalibrate flow sensor. Refit sensor into patient circuit. If to be used without sensor press "Continue without flow" and set breath trigger sensitivity. Remove sensor from patient circuit. Discard the flow sensor. Fit new flow sensor and recalibrate. Refit sensor into patient circuit. If no replacement sensor available press "Continue without flow" and set breath trigger sensitivity.
Alarm Message: Calibrate Flow Sensor.	New sensor connected to ventilator.	Carry out calibration routine. Fit sensor into patient circuit.
Alarm Message: User interface has reset. Confirm settings	Internal hardware reset has occurred.	Remove ventilator from service. If generated whilst connected to a patient, remove patient to alternative form of ventilation Note alarm message and refer ventilator to qualified service personnel.
Alarm Message: O2 sensor disconnected. Please reconnect..	The oxygen sensor cell has become disconnected.	Remove patient to alternative form of ventilation, then remove ventilator from service. Note alarm message and refer ventilator to qualified service personnel.
Calibrate Oxygen cell alarm. Alarm Message: The Oxygen Cell needs calibrating.	The oxygen sensor has registered >100% oxygen concentration.	Recalibrate O2 sensor. If sensor at fault a new oxygen cell alarm will be generated. If this messages appears remove patient to alternative form of ventilation, then remove ventilator from service. Note alarm message and refer ventilator to qualified service personnel.

Symptom	Possible Cause	Remedy
Oxygen calibration failure. Alarm Message: O2 Claibration Fail	During the oxygen sensor calibration the ventilator could not achieve a reading of 100% oxygen.	Remove patient to alternative form of ventilation, then remove ventilator from service. Note alarm message and refer ventilator to qualified service personnel.
Monitor/Display Comms fail alarm. Alarm Message: Internal communication fault. Remove ventilator from use.	A hardware/software fault has developed within the ventilator.	Remove patient to alternative form of ventilation, then remove ventilator from service. Note alarm message and refer ventilator to qualified service personnel.
High or low pressure alarm with fresh gas cut off. Pressure spike of 20mbar or greater followed by no fresh gas. Alarm Message: High Pressure threshold exceeded. or Low Pressure.	A hardware fault has developed within the pneumatic unit of the ventilator.	a) Check the alarm thresholds are set correctly. b) Press the Reset button to restart ventilation. If the pressure spike is generated the ventilator will cut all gases again. c) Remove the patient immediately to an alternative form of ventilation. d) Remove the ventilator from service and refer ventilator to qualified service personnel.

38.3 Sensor Related Problems

Warning: In all alarm conditions check the patient first.

etCO2 sensor

Symptom	Possible Cause	Remedy
Alarm Message: Replace etCO2 filterline	Blocked filterline	First disconnect and reconnect the FilterLine™. If the message still appears, disconnect and replace the FilterLine™. Once a working FilterLine™ is attached to the module, the pump will automatically resume operation.

This page is intentionally left blank.

PPM & Functional testing



39. Planned preventative Maintenance (PPM)

Warning. Planned preventative Maintenance of this ventilator should only be carried out by a SLE trained hospital engineer or an SLE service engineer.

39.1 PPM schedule

Year	Use PPM Kit A	Use PPM kit B*
1	A	
2	A	
3	A	
4	A	
5	A	
6	A	B*
7	A	
8	A	
9	A	
10	A	

*Note: Kit B shall be used at 6 years or 30,000 hours, which ever is sooner. The time in hours should be taken from the hour counter mounted in the rear of the pneumatic chassis.

The hour counter only records the time the ventilator is in operation i.e. turned on.

39.2 PPM kits

The SLE6000 has two PPM kits, A & B.

39.2.1 Kit A

Kit contains the following.

Oxygen sensor cell	Qty. 1
Conical filter	Qty. 2
Duckbill valve	Qty. 2
Duckbill washer	Qty. 2
“O” rings	Qty. 2
Orifice block “O” rings	Qty. 2
Particulate filters 5µm	Qty. 2

39.2.2 Kit B

Proportional valve kit (3 valves) Qty. 1

High speed valve assembly Qty. 1

Each PPM kit will require the installation of the above parts and a re-calibration.

39.3 Kit part numbers

Kit A N9610/A

Kit B N9610/B

Note: A service manual is available for use by qualified engineers who have been trained by SLE on this product.

The service manual contains full illustrated parts list, circuit diagrams, pneumatic diagrams and calibration procedure for the ventilator.

Contact SLE or your distributor for further information.

39.4 Mains cable replacement

Warning. The replacement of the mains cable should only be carried out by a SLE trained hospital engineer or an SLE service engineer.

Remove the two screws (A) to release the clamp (B).

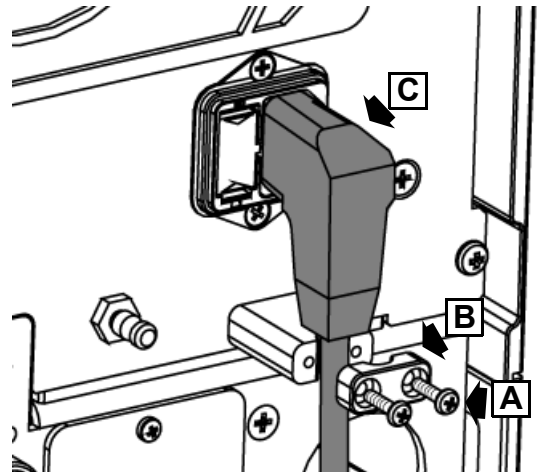

Remove the mains cable (C).

Only replace the cable with one of the following cables available from SLE:

Mains cable 3M long UK 3 pin plug. P/Nº:M0255/095

Mains cable 3M long Shuko plug. P/Nº:M0255/096

Mains cable 3M long NEMA plug. P/Nº:M0255/097

39.5 MicroPod™ PPM

A calibration should be performed after the initial 1,200 hours of use, and following that calibration once a year or every 4,000 operating hours, whichever comes first.

After 30,000 operating hours, certain components of the capnography module need servicing. Only a trained technician can provide this service. Consult SLE or your distributor for more information.

The ventilator will display from the etCO₂ sensor tab the following information:

- Date of last calibration
- Date of next calibration
- Date of next service

Note: A service manual is available for use by qualified engineers who have been trained by SLE on this product.

Order SM38 issue 5 or higher

The service manual contains the calibration procedure for the MicroPod™.

Calibration of the MicroPod™ requires the use of a calibration Gas.

Contact SLE or your sales distributor for further information.

40. Ventilator Functional testing

Functional testing can be performed if the user wants to check the operation of the alarms or the basic performance of the ventilator.

Functional testing is broken down into two sections, alarm testing and performance testing.

40.1 Alarm testing



The alarm test routine allows the user to test the essential performance of the following alarms:

Alarm type	Alarm message
High Oxygen	High oxygen level
Low Oxygen	Low oxygen level
PEEP alarm	CPAP to high/ PEEP to high
Obstruction alarm	Blocked fresh gas
Partial occlusion alarm	Continuing positive pressure
Expired volume alarm	Tidal volume above high threshold
Low volume alarm	Minute volume below low threshold
Power supply failure alarm	Main power fail
Loss of gas supply alarm	No air supply No O ₂ supply
High Pressure alarm	High pressure threshold exceeded

- 1 Use the standard ventilator set up as described in “Ventilator basic setup” on page 42.
- 2 Connect a full patient circuit and test lung.

Warning: The patient circuit used for functional testing must not be used for patient ventilation.

- 3 Select and enter CMV mode.
- 4 Ensure that the oxygen system has completed its calibration.

40.1.1 High Oxygen/Low Oxygen/Loss of gas supply alarm test

- 1 Set the O₂ control to 21%.
- 2 Disconnect the Air supply. (The ventilator will now switch to 100% oxygen).
- 3 The loss of air supply alarm will now trigger (Message “No Air Supply”).
- 4 Allow the O₂ measured value to reach 100%.
- 5 Reconnect the Air supply.

- 6 The High oxygen alarm (Message "High Oxygen level") will be triggered.
- 7 Set the O2 control to 25%.
- 8 Disconnect the oxygen supply. (The ventilator will now switch to 100% air).
- 9 The loss of oxygen supply alarm will now trigger (Message "No O2 supply").
- 10 Disconnect the air supply
- 11 The loss of gas supply alarm will now trigger (Message "No Gas").
- 12 Reconnect both gases.

40.1.2 Obstruction alarm - Blocked fresh gas

- 1 Still in CMV mode remove the inspiratory supply line and obstruct the "Fresh gas to Patient" port.
- 2 Press the reset button until the "Blocked fresh Gas" alarm appears.
- 3 Reconnect the inspiratory supply line and reset all alarm messages.

40.1.3 Partial occlusion alarm - Continuing positive pressure

- 1 Change mode to CPAP
- 2 Gently constrict the exhalation limb tube to increase the measured pressure to just under the high PIP alarm threshold. Ensure that the pressure waveform does not cross the High PIP alarm threshold.
- 3 The partial occlusion alarm will now trigger, (Message "Continuing positive pressure") and the gases will be cut.

Note: The CPAP to high alarm will be triggered first but will then be overridden by the Continuing positive pressure alarm

- 4 Release the constriction from the exhalation limb tube.

40.1.4 High Pressure alarm - High pressure threshold exceeded

- 1 Block the proximal airway line by creating a folding the line over.
- 2 The pressure waveform should increase above the high PIP alarm threshold.
- 3 The high pressure alarm will now trigger, (Message "High Pressure Threshold Exceeded").

40.1.5 Expired volume alarm - Tidal volume above/below threshold

- 1 Change mode to HFO.
- 2 Set the ΔP to 80 mbar.
- 3 Open the alarm panel.
- 4 Reduce the upper Vte alarm threshold to below the measured value.
- 5 Wait for approximately 20 seconds and the high expired volume alarm will now trigger, (Message "Tidal volume above high threshold").
- 6 Return the high alarm threshold to 30 ml.
- 7 Reset any alarm messages.
- 8 Increase the lower Vte alarm threshold to above the measured value.
- 9 Wait for approximately 20 seconds and the low expired volume alarm will now trigger, (Message "Tidal volume below low threshold").
- 10 Return the low alarm threshold to 0 ml.
- 11 Reset any alarm messages.

40.1.6 Volume alarm - Minute volume above/below threshold

- 1 Reduce the upper Vmin alarm threshold to below the measured value.
- 2 Wait for approximately 20 seconds and the high minute volume alarm will now trigger, (Message "Minute volume above high threshold").
- 3 Return the high alarm threshold to 18 l.
- 4 Increase the lower Vmin alarm threshold to above the measured value.
- 5 Wait for approximately 20 seconds and the low minute volume alarm will now trigger, (Message "Minute volume below low threshold").
- 6 Return the low alarm threshold to 0 l.

40.1.7 Power supply failure alarm - Main power fail and battery check

- 1 Disconnect the mains power by removing the plug from the supply socket.
- 2 The power supply failure alarm will now trigger, (Message "Main power fail").
- 3 Check that the AC symbol is no longer present, symbol located next to battery icon.
- 4 Reconnect the mains power by inserting the plug into the supply socket.
- 5 The alarm message will cancel.

- 6 Check that the AC symbol is present, symbol located next to battery icon.
- 7 Ensure that the ventilator continues to operate normally.
- 8 Ensure a battery percentage is displayed.
- 9 Change mode to CMV.

Warning: If any of the above test fail do not use the ventilator but withdraw it from service and refer it to qualified service personnel for repair/re-calibration.

40.2 Performance testing.

The performance test is divided into two steps, conventional and oscillatory.

40.2.1 Conventional



- 1 Remove the flow sensor from the ET manifold and occlude the ET manifold.
- 2 Disconnect the flow sensor and press "Continue without flow sensor".
- 3 Set the following:
RR 30 BPM
Ti 1 second
PEEP 0 mbar
PIP 15 mbar
- 4 Confirm that the measured PIP is 15 mbar \pm 1 mbar.
- 5 Confirm that the measured PEEP is 0 mbar \pm 1 mbar.

40.2.2 Oscillatory



- 1 Change mode to HFO.
- 2 Set the following:
Frequency 5 Hz
I:E ratio 1:1
MAP 0 mbar
 Δ P 20 mbar
- 3 Confirm that the measured MAP is 0 mbar + 1 mbar.
- 4 Set the Δ P to 150 mbar
- 5 Confirm that the measured MAP is 0 mbar + 5 mbar.
- 6 Set the Δ P to 180 mbar
- 7 Confirm that the measured Δ P is >150 mbar.
- 8 Confirm that the measured MAP is 0 mbar + 12 mbar.
- 9 Set the ventilator to standby
- 10 Remove the test circuit.
- 11 Functional testing is now complete.

41. External sensor functional testing

41.1 Masimo SET®



- 1 Use the standard ventilator set up as described in "Ventilator basic setup" on page 42.
- 2 Connect a full patient circuit and test lung.

Warning: The patient circuit used for functional testing must not be used for patient ventilation.

- 3 Do not connect a flow sensor.

41.1.1 Masimo SET® Functional testing

Note: To test the alarms the user will have to use one of the following sensors Masimo Inf-3 or Masimo Neo-3 or Masimo NeoPt-3.

- 1 Setup the Masimo sensor as described in section '18.2 Masimo SET® Connection' on page 99.
- 2 From the "Utilities" Sensor tab press the SpO₂ button.
- 3 Turn on SpO₂ monitoring.
- 4 Select CMV mode.
- 5 Press "Continue Without Flow sensor" button.
- 6 Reset all alarm messages.
- 7 Press the "Alarm" button and select the "Current" tab.
- 8 The message "Sensor Off patient" should be displayed.
- 9 Disconnect the sensor from the adaptor cable.
- 10 The "No SpO₂ Sensor connected" alarm should appear.
- 11 Reconnect the sensor and the message should return to "Sensor Off patient".

41.1.2 Masimo SET® SpO₂ and PR alarms

- 1 The user should apply the selected sensor to a finger.
- 2 Wait for the ventilator to display the measured SpO₂ reading.
- 3 Enter the alarm panel.
- 4 Increase the SpO₂ low alarm threshold above the measured SpO₂ value.
- 5 Wait for the SpO₂ low alarm to be triggered.

- 6 Reset the Low Threshold below the measured value.
- 7 Decrease the SpO₂ high alarm threshold above the measured SpO₂ value.
- 8 Wait for the SpO₂ high alarm to be triggered.
- 9 Reset the Low Threshold below the measured value.
- 10 Reset all alarm messages.
- 11 Press the "Layout" button.
- 12 Select "Waveforms" and press Edit.
- 13 Set the SpO₂ waveform to ON and press the confirm button.
- 14 Increase the PR low alarm threshold above the measured PR value displayed in the waveform title bar.
- 15 Wait for the PR low alarm to be triggered.
- 16 Reset the Low Threshold below the measured value.
- 17 Decrease the PR high alarm threshold above the measured PR value.
- 18 Wait for the PR high alarm to be triggered.
- 19 Reset the Low Threshold below the measured value.
- 20 The SpO₂ alarms test are now complete.

41.2 MicroPod™

- 1 Use the standard ventilator set up as described in “Ventilator basic setup” on page 42.
- 2 Connect a full patient circuit and test lung.



- 9 Reset the Low Threshold below the measured value.
- 10 Reset all alarm messages.
- 11 The etCO₂ alarm test is now complete.

Warning: The patient circuit used for functional testing must not be used for patient ventilation.

- 3 Do not connect a flow sensor.

41.2.1 MicroPod™ Functional testing

Note: To test the alarms the user will have to use a compatible FilterLine™.

- 1 Setup the MicroPod™ as described in section '18.11 EtCO₂ monitoring (MicroPod™)' on page 104.
- 2 From the “Utilities” Sensor tab press the etCO₂ button.
- 3 Turn on etCO₂ monitoring.
- 4 Select CMV mode.
- 5 Press “Continue Without Flow sensor” button.
- 6 Reset all alarm messages.
- 7 Press the “Alarm” button and select the “Current” tab.
- 8 The message “Sensor Off patient” should be displayed.
- 9 Disconnect the sensor from the adaptor cable.
- 10 The “No SpO₂ Sensor connected” alarm should appear.
- 11 Reconnect the sensor and the message should return to “Sensor Off patient”.

41.2.2 MicroPod™ etCO₂ alarm

- 1 The user should blow into the filter line.
- 2 Continue to blow until the ventilator displays the measured etCO₂ reading.
- 3 Enter the alarm panel.
- 4 Increase the etCO₂ low alarm threshold above the measured etCO₂ value.
- 5 Wait for the etCO₂ low alarm to be triggered.
- 6 Reset the Low Threshold below the measured value.
- 7 Decrease the etCO₂ high alarm threshold above the measured etCO₂ value.
- 8 Wait for the etCO₂ high alarm to be triggered.

This page is intentionally left blank.

Installation instructions

“Unpacking.” on page 260

“Medicart assembly” on page 261

“Ventilator unpacking” on page 262

“Ventilator assembly to Medicart” on page 263

“Mains cable attachment” on page 264

“Pre-use functional test.” on page 264

“Ventilator configuration” on page 264



42. Installation instructions

The following installation instructions allow the user to assemble the ventilator and functionally test the ventilator.

Warnings:

The ventilator should be commissioned only by qualified service personnel.

Warnings:

A complete ventilator-trolley shipping carton weighs approximately 60kg and requires 2 person lifting.

The Ventilator carton weighs approximately 25 kg and removal from the shipping carton requires 2 person lifting.

The ventilator weighs 22kg ±0.5kg. Failure to secure the ventilator to the trolley can cause the ventilator to fall off when in transit.

Failure to secure the mains inlet cable to the ventilator can cause the mains to be disconnected whilst in use.

Failure to secure either the mains cable or the ventilator, places the machine in an unsafe state, and the ventilator should not be used until these two items are rectified.

The following is the order for installation.

- A. Unpacking
- B. Trolley assembly.
- C. Ventilator mounting.
- D. Ventilator setup.

Note: The ventilator is supplied with a commissioning procedure in the accessories box.

42.0.1 Tools required for trolley assembly

5mm A/F Allen key	Qty. 1
3mm A/F Allen key	Qty. 1
Pozi drive screwdriver	Qty. 1

42.1 Unpacking.

1. Place the shipping carton on a flat surface with access to all sides.



2. Open the top of the shipping carton and remove the packing strips (A, B & C), this is to allow access to the lifting handle for the ventilator carton.

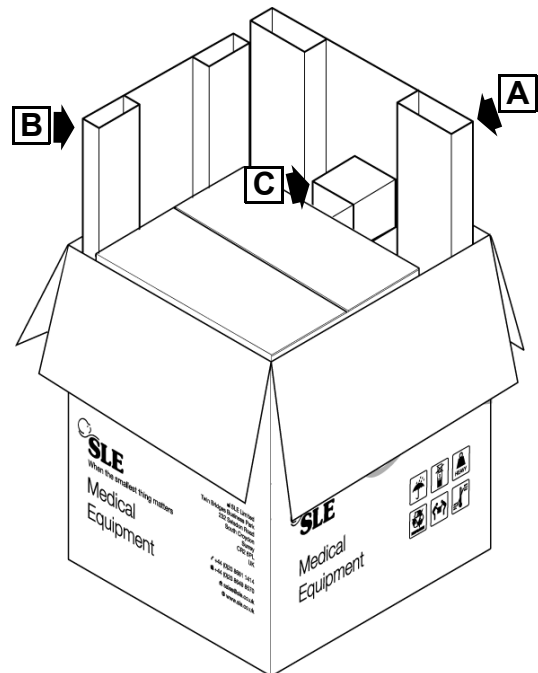

Note: The packing strip (C) may be replaced by a humidifier heater base.

Note: Accessory bags may be inserted into the voids.

3. Remove the ventilator carton by using the lifting handles.



Note: This step requires two person lifting from points D and E.

4. Remove the Medicart carton from the base of the box.

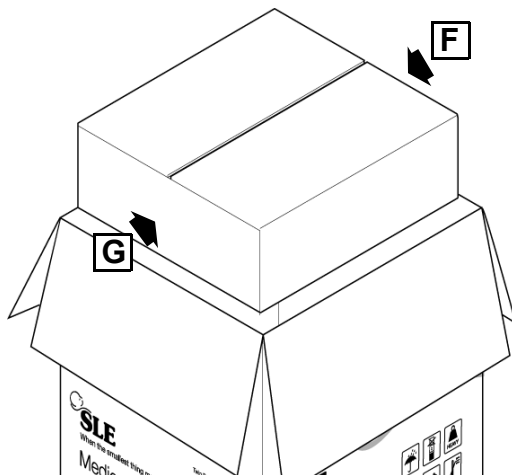

Note: This step requires two person lifting from points F and G.

5. The next stage is to assemble the Medicart.

42.2 Medicart assembly

42.2.1 Medicart kit contents

Top plate assembly	Qty. 1
Support column	Qty. 1
Base plate with castors	Qty. 1
Hose hook	Qty. 1
Humidifier mount	Qty. 1
Screws M6 button head	Qty. 6
Washers	Qty. 6
Screws M6 Countersunk head ..	Qty. 10

42.2.2 Assembly

1. Attach support column to wheel base using 6 button head screws and spring washers. Ensure the basket support (A) faces the towards the locking castors (B) of the base.

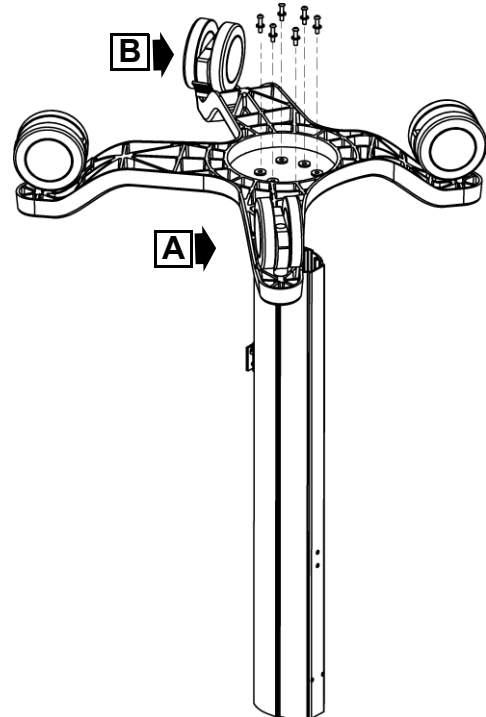

Note: This step requires two person assembly.

2. Rotate the base and column and lock the front wheels. Attach top plate (C) to the centre column using 6xM6 countersunk screws (D).

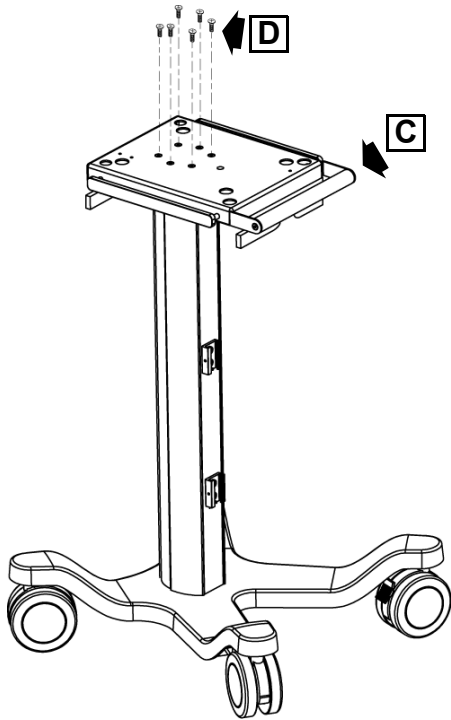

3. Attach hook (E) to the column with 2xM6 countersunk screws. Slide the basket (F) into the lower accessory mount, an optional set screw is supplied for locking.

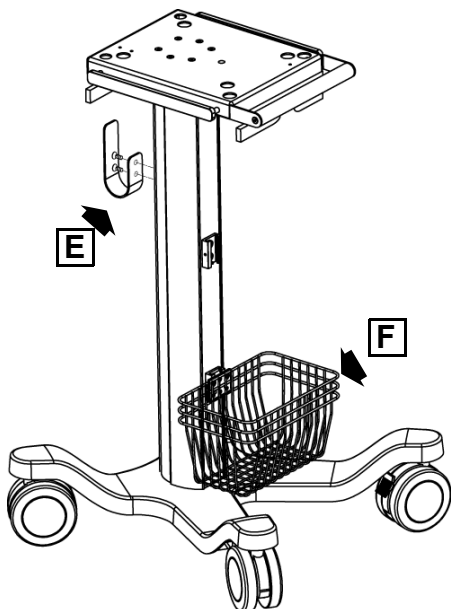

42.3 Ventilator unpacking

1. Place the ventilator carton on a flat stable surface.



2. Remove the packing tape securing the top flaps and open the flaps fully.

3. Remove the accessories (A) packed in the two pockets of the large insert.

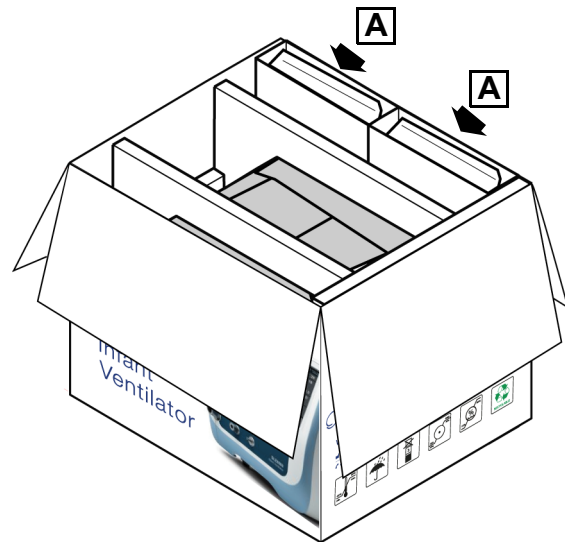

4. Remove the upper foam insert (B) and the two cardboard inserts (C & D).

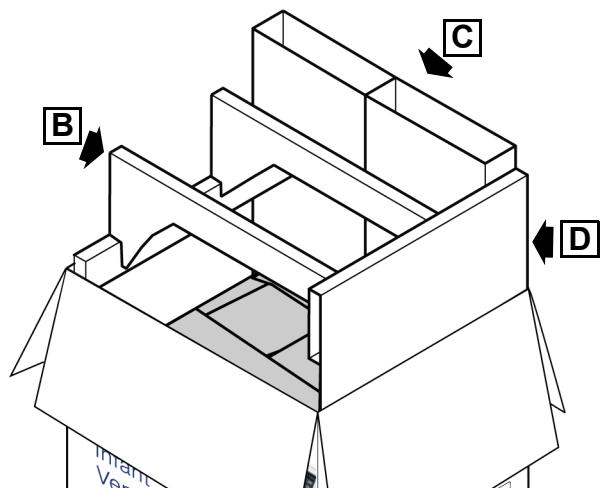

5. Lift the ventilator out of the base foam pad using the rear lift point (E) and the front lift point (F). The front lift point (F) is the scoop at the front of the ventilator which is partly covered by the support foam.

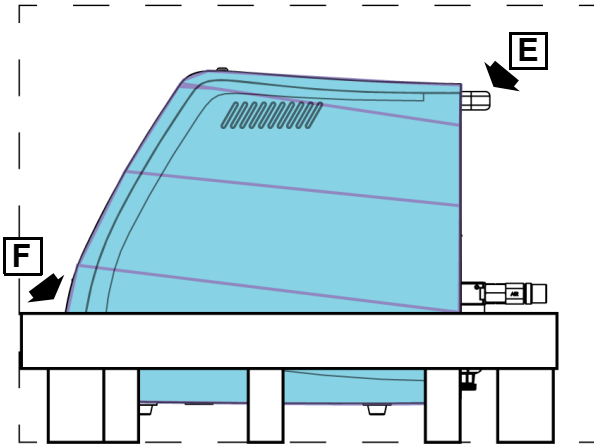

6. Place the ventilator on a stable flat surface and remove the protective film. Remove the two red protective caps (G).

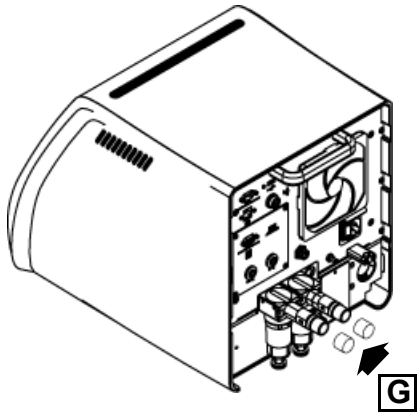

The ventilator is now ready to be mounted to the Medicart. If the ventilator is not to be mounted on a Medicart then advance to section 42.6 "Mains cable attachment" .

Note: Retain the packaging for future use.

42.4 Ventilator lifting points

The following are the lifting points for the ventilator.

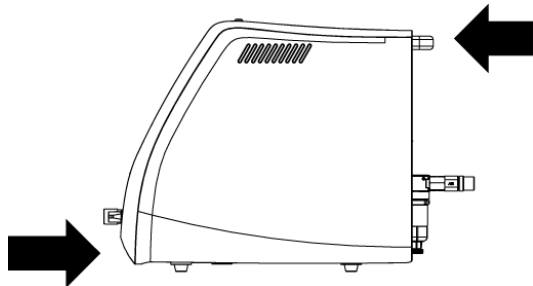

The front scoop and the rear handle.

42.5 Ventilator assembly to Medicart

Place the ventilator on the Medicart.

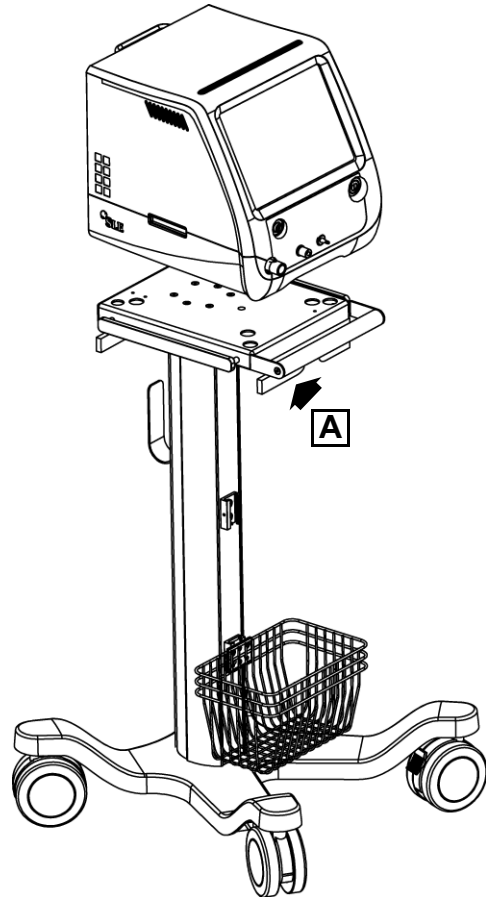

Ensure that all the feet protrude through base tray holes. Secure the ventilator by using the captive screw (A) located on the underside of the base plate.

42.6 Mains cable attachment

The mains cable need to secured via the attached clamp..

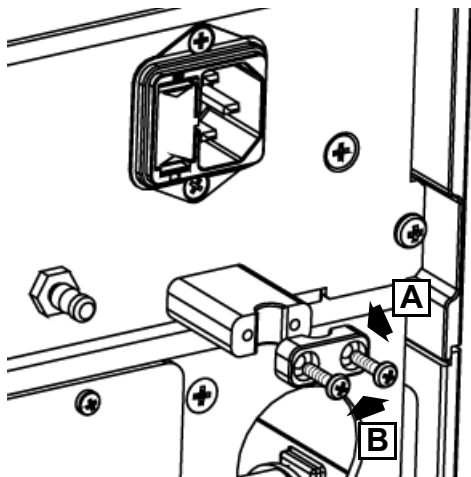

Note: The mains lead is found in the accessories pack supplied with the ventilator

Remove the cable clamp (A) by removing the two screws (B).

Insert the mains cable (C) into the inlet socket.

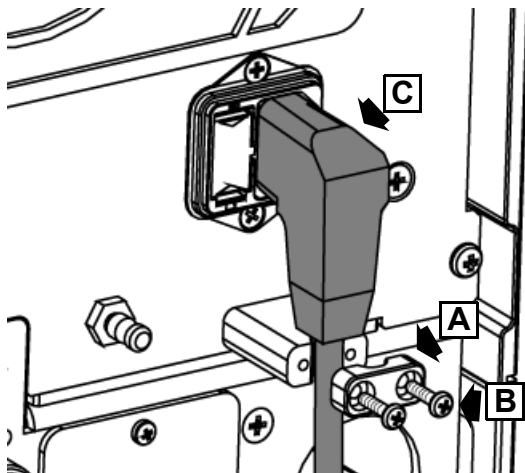

Secure the cable by refitting the cable clamp (A) using the two screws (B).

42.7 Pre-use functional test.

Carry out the “Ventilator basic setup” on page 42 and the “Functional testing (Invasive dual limb)” on page 45.

42.8 Ventilator configuration

The ventilator is shipped with factory defaults as listed in the technical specification. The user can configure the ventilator by setting the user defined features from the user preference application. See “User preferences” on page 266.

User preferences

“Accessing user preferences” on page 266

“Parameters tab” on page 266

“Ventilation tab” on page 267

“Alarms tab” on page 267

“Interface tab” on page 268

“Regional tab” on page 268

“Save / Quit tab” on page 268



43. User preferences

This section describes all the features of the user preference interface.

Note: User preferences can only be selected from “Standby mode”.

43.1 Accessing user preferences

To access user preferences select “Utilities” or “Calibration/Utilities” > “System” > “User preferences”.

The user preferences number pad will be displayed.



Enter the default code of 0420 and press the confirm button. The user will now be presented with the user preferences “Parameters” tab as the default.

43.1.1 Parameters tab

Form this tab the user can select the following:

- Parameters - Setting user defaults for power up.
- Ventilation - Setting of ventilation pre-sets
- Alarms - Setting of alarm defaults.
- Interface - Setting of interface defaults.
- Regional - Setting on Language and units.
- Save/Quit - Save settings and factory reset.

43.1.1.1 Parameters

From this panel the following can be set.

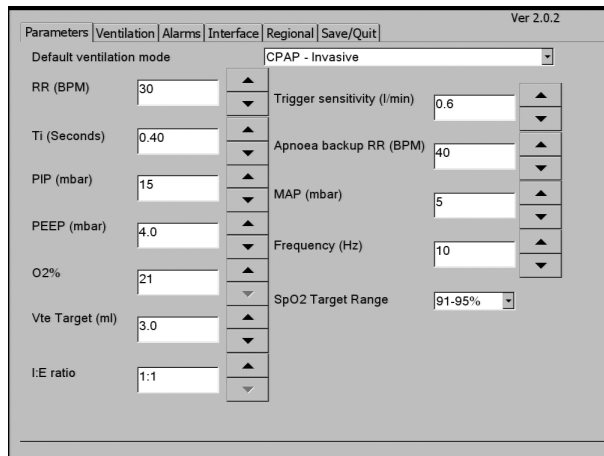

Default ventilation mode.

RR (BPM) Range 1 to 150 BPM¹
Default 30 BPM

Ti (seconds) Range 0.1 to 3 seconds²
Default 0.4 seconds

PIP (mbar) Range 0 to 65 mbar³
Default 15 mbar

PEEP (mbar) Range 0 to 35 mbar⁴
Default 4 mbar

O2% Range 21 to 100 %
Default 21%

VTe Target (ml) Range 2 to 300 ml
Default 3 ml

I:E ratio 1:1, 1:2 & 1:3
Default 1:1

Trigger sensitivity (l/min) 0.2 to 20 l/min
Default 0.6 l/min

Apnoea backup RR (BPM) 1 to 150 BPM
Default 40 mbar

MAP (mbar) 2 to 45 mbar
Default 5 mbar

Frequency (Hz) 3 to 20 Hz
Default 10 Hz

SpO₂ target range 90-94%
91-95% Default
92-96%
94-98%

Note¹: This parameter is limited by the set Ti.
Note²: This parameter is limited by the set RR.
Note³: This parameter is limited by the set PEEP.
Note⁴: This parameter is limited by the set PIP.

43.1.2 Ventilation tab

The ventilation tab sets the preference for features available in a ventilatory mode.

Manual breath maximum hold - Set Ti, 5 seconds and 10 seconds. (Default set Ti)

Manual sigh maximum hold - Set Ti, 5 seconds and 10 seconds. (Default set Ti)

O2 Boost⁵ - ON or OFF (Default OFF)

O2 Suction⁵ - ON or OFF (Default OFF)

Pre-Set O2 for O2 Boost or O2 Suction - 100% or adjustable from 1 to 10% (Default 5%)

Note⁵: Only one function can be enabled. If the user turns on one function then tries to turn on the other the first active function is automatically turned OFF.

43.1.3 Alarms tab

The alarm tab sets the preference for default limits for the displayed alarms available in a ventilatory mode.

High RR (BPM) - Range 0 to 150 BPM (Default 100 BPM).

High minute volume Conventional (ml) - Default 18000 ml.

Low minute volume Conventional (ml) - Default 0 ml.

High minute volume HFO (ml) - Default 18000 ml.

Low minute volume HFO (ml) - Default 0 ml.

Apnoea time (sec) - Range 5 to 60 sec (Default 15sec).

High SpO₂ - Range 6 to 99 % (Default 99%) limited by Low SpO₂ value.

Low SpO₂ - Range 5 to 98 % (Default 89%) limited by High SpO₂ value.

High Pulse rate (BPM) Range 31 to 235 BPM (Default 180 BPM) limited by Low Pulse rate value.

Low Pulse rate (BPM) Range 30 to 234 BPM (Default 100 BPM) limited by High Pulse rate value.

High etCO₂ (mmHg) Range 10 to 95 mmHg (Default 50 mmHg) limited by Low etCO₂ value.

Low etCO₂ (mmHg) Range 5 to 90 mmHg (Default 20 mmHg) limited by High etCO₂ value.

43.1.4 Interface tab

The interface tab sets the user interface preferences for features available in a ventilatory mode.

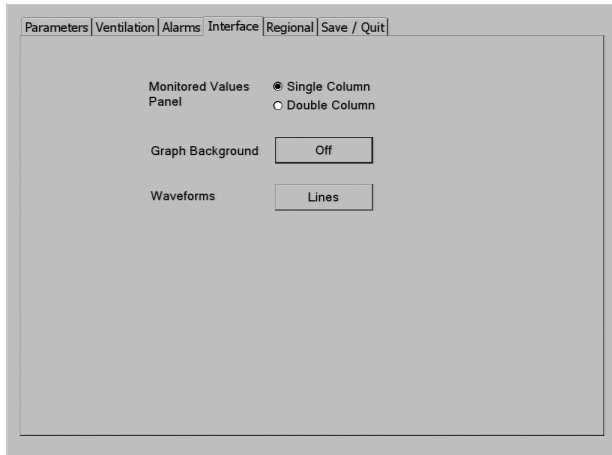

Monitored values panel Single column or Double column (Default Single column)

Graph background - OFF or ON (Default OFF)

Waveforms - Lines or filled in (Default lines)

43.1.5 Regional tab

The interface tab sets the user interface preferences for features available in a ventilatory mode.

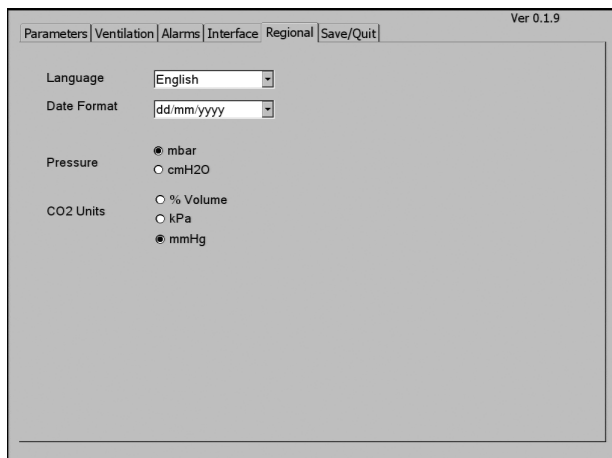

Language - English (Default English)

Available languages:

- French
- Spanish
- German
- Italian
- Dutch
- Polish
- Russian
- Portuguese
- Turkish
- Japanese
- Greek

- Chinese
- Ukrainian
- Swedish.

Note: Only for the Chinese language when selected a new feature becomes available. The new feature is to disable “Continue without flow sensor” button for the “Flow sensor not connected” alarm condition.

Date Format - dd/mm/yyyy or mm/dd/yyyy (Default dd/mm/yyyy)

Pressure - mbar or cmH2O (Default mbar)

CO2 Units - % Volume, kPa or mmHg.

43.1.6 Save / Quit tab

The Save / Quit tab allows the user to save or discard change to the user preferences.

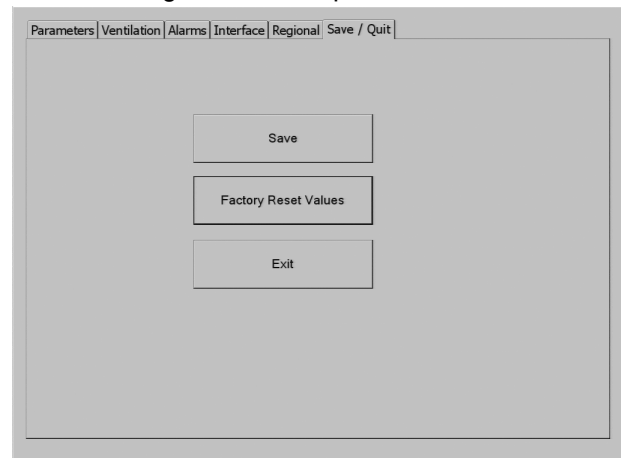

The user is presented with three options.

Save

Factory reset values

Exit

Pressing Save will record the changes to system memory. Press OK to return to the main menu.

Pressing Factory reset values will reset the ventilator to factory defaults but not record the changes to system memory. The user should press either the OK or SAVE button to record the changes to system memory.

Pressing EXIT will end the user preference session. The user will have to press and hold the power button for 15 seconds to cycle the power.

Caution. Pressing the exit button without saving will discard all changes made in this session. The user will have no option but to cycle power and repeat the process.

Event and patient log software



44. SLE 6000 Event and Patient Log viewer software

Caution: SLE 6000 Event and patient log software is intended for research purposes only. SLE 6000 Event and patient log software must not be used for clinical purposes including diagnosis or patient monitoring.

Caution: Ensure exported ventilation data is protected in accordance with local laws and regulations. Refer to institutional controls and processes to store, safeguard and protect the exported ventilation data and files.

44.1 Minimum system requirements

Operating system...	Windows 7
CPU.....	Pentium or compatible, 300MHz
Memory	128 MB
Hard drive.....	2 GB
Media	CD-ROM drive or USB port
Display	Super VGA (800 × 600)
Input device(s).....	Keyboard, mouse
.Net Framework.....	version 3.5

44.1.1 Memory stick requirements

Type	USB2
Size	Minimum 1Gb

44.2 Installation of software

Insert the SLE USB memory stick supplied with the ventilator into the host computer.

When the AutoPlay window appears select "Open folder to view files".

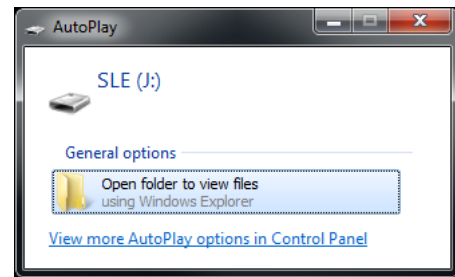

Open the folder Setup Wizard.

Select the file "SetupLogViewer.msi".

Right click the set up wizard "SetupLogViewer.msi" and select "Install".

Set up wizard for Log Viewer opens. Press "Next" in the set up wizard

Press "Next" in Select Installation folder dialogue

Press "Next" in the Confirm Installation dialogue

Close the installer

A shortcut "Log Viewer" is automatically installed in user's desktop.

44.3 Downloading the Patient log or Event log

The process for downloading the log files is the same for Patient or Event log.

The Patient log process is shown below.

Turn on the ventilator and allow it to enter Standby mode.

Insert a USB memory stick into the data port at the rear of the ventilator.

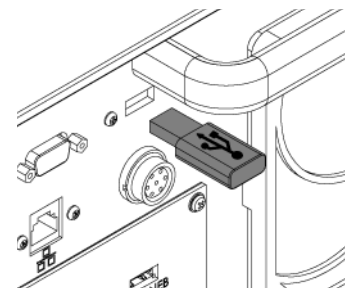

Activate the Utilities tabs (1) and select the Data tab (2).

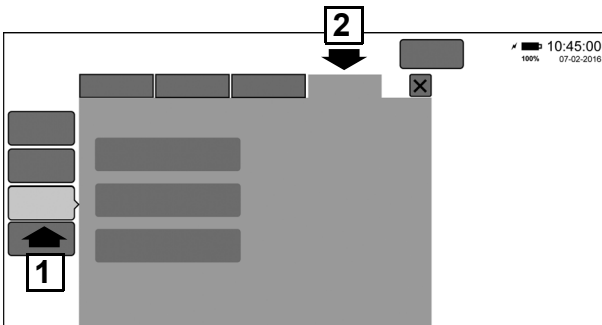

Select the Patient Log button

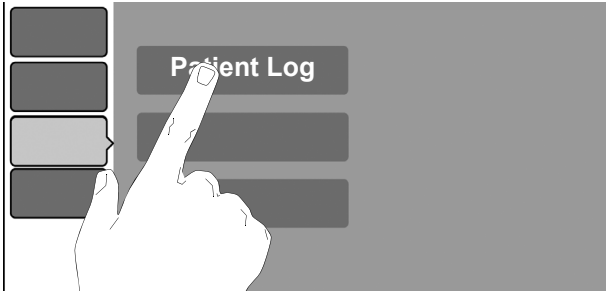

On selection of the Patient log button the “Start Export” button becomes active. Press the button to start the export to the USB memory stick.

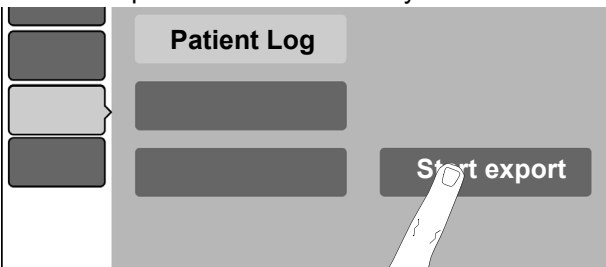

The ventilator will display a progress bar during the export process. Also displayed is a cancel button that allows the user to terminate the export process.

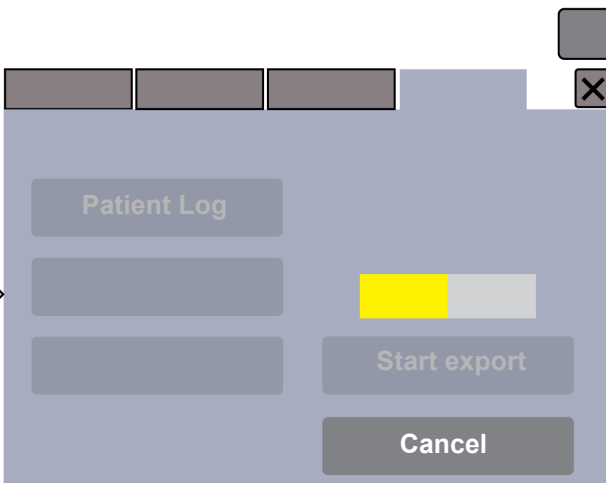

When complete the ventilator will indicate that the data export was OK.

Remove the USB memory stick from the ventilator.

44.4 Export file formats

The SLE6000 creates a folder with a identification number that is unique that ventilator.

Example: Ventilator ID 1001453795

Within the folder the user will find a number of files. Each file is prefixed with the date followed by serial code and then file type.

Example: 16_03_31_192222_RealtimeLog.dat

The patient log generates 3 files:

1. 16_03_31_192222_Realtimelog.dat
2. 16_03_31_192225_AlarmsLog.txt
3. 16_03_31_192335_TrendsDataLog.dat

The event log generates 2 files:

1. 16_03_31_192345_SystemLog.evt
2. 16_03_31_192225_DebugLog.evt

Note: The ventilator does not overwrite any existing files but creates new files with a different serial code.

The ventilator will check the USB memory stick for enough free space for the new export files. If not enough free space is available the ventilator will display the following message “The USB stick does not have enough free space. Minimum XMB free space needed”.

Note: If the user also exports the screen captures these will be located within the same folder.

**File name:
16_04_01_193759_ScreenCapture_01.bmp**

44.4.1 File types

The ventilator creates three file types, .dat .evt and .txt. The .dat and .evt files can only be read by the supplied viewer software. the .txt file can be read by most desk top publishing or spreadsheet programs.

44.4.1.1 RealtimeLog

File type: 16_03_31_192222_RealtimeLog.dat

The RealtimeLog captures the real time waveform data for pressure, flow, volume and CO2 (CO2 not implemented in this release of software).

44.4.1.2 AlarmsLog

File type: 16_03_31_192225_AlarmsLog.txt

The AlarmsLog captures all alarm conditions.

44.4.1.3 TrendsDataLog

File type:16_03_31_192335_TrendsDataLog.dat

The TrendsDataLog contains the following trend data

- 1) PIP
- 2) PEEP
- 3) MAP
- 4) CPAP
- 5) DeltaP
- 6) Vte
- 7) Vte Spont
- 8) Vmin
- 9) %VminSpont
- 10) RR
- 11) RR Spont
- 12) Triggers
- 13) CO₂
- 14) SpO₂
- 15) Resistance
- 16) Compliance
- 17) DCO₂
- 18) Pulse Rate
- 19) SIQ
- 20) Reference O₂
- 21) Set FiO₂
- 22) Current measured O₂

44.4.1.4 SystemLog

File type:16_03_31_192345_SystemLog.evt

The SystemLog captures all the user interaction with the ventilator.

Including the SpO₂ target range.

44.4.1.5 DebugLog

File type:16_03_31_192225_DebugLog.evt

The DebugLog captures all the software messages. This feature is for service personnel only.

44.4.1.6 Log records

Each log can store 64,000 records apart from the AlarmsLog which is limited to 1000. When any log becomes full the oldest log entry is deleted and all current log entries move down to make room for the new log entry.

44.5 Log Viewer Features

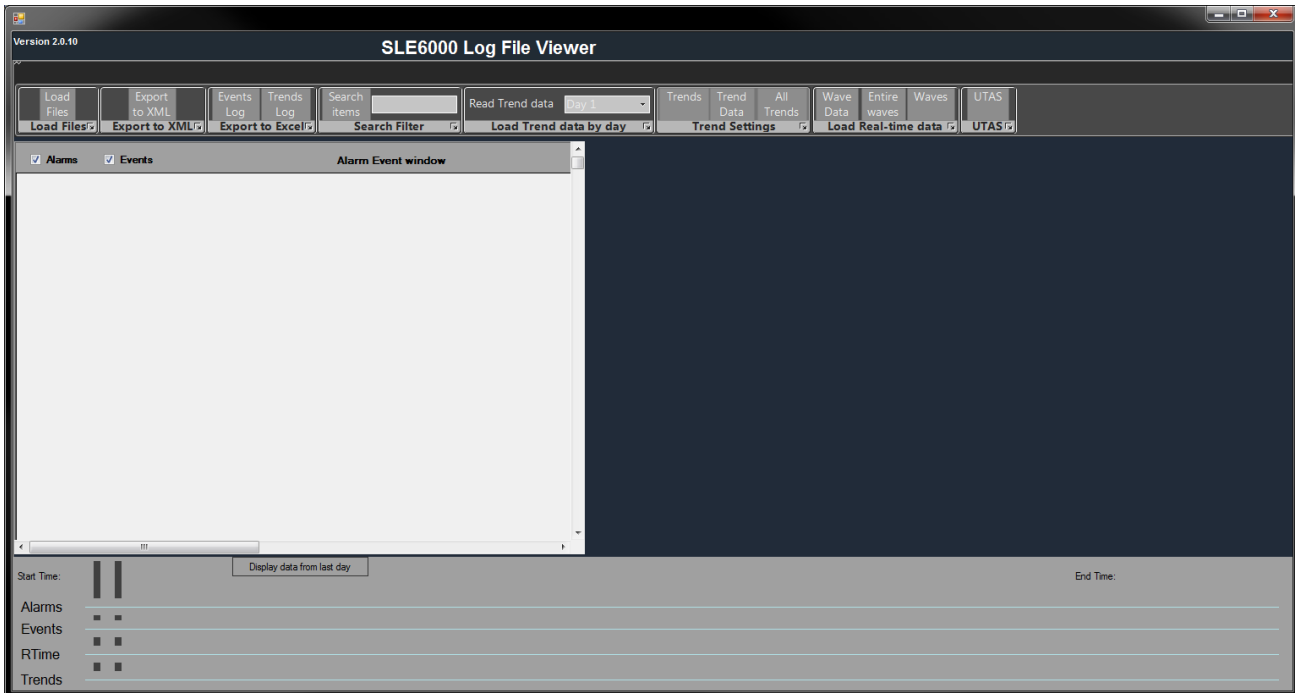

44.5.1 Load Files

This button is used to load the events log ("SystemLog.evt"), alarms log("AlarmsLog.txt") and Trends log ("TrendsDataLog.dat").

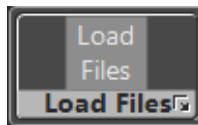

Press "Load files" button, and select files to be opened. To select multiple files, press "Ctrl" button in the keyboard and select all three files (SystemLog.evt, AlarmsLog.txt and TrendsDataLog.dat) to be opened.

Within around 30 - 60secs events and alarms will be loaded and displayed in the "Alarm Event window" (window in the left side of the application).

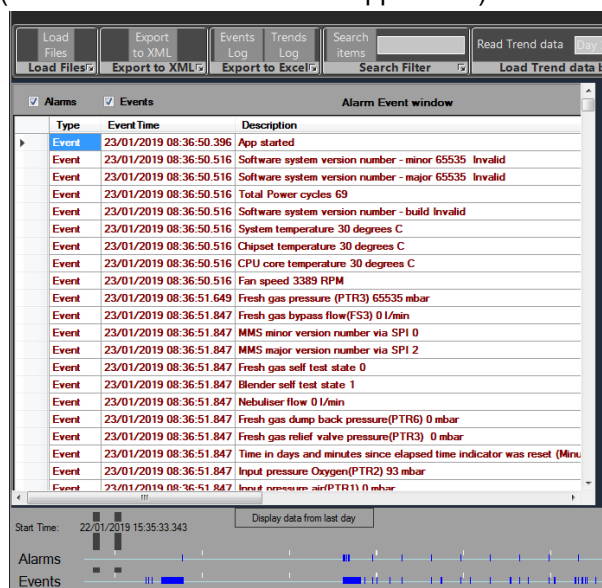

Also the start time, end time and date time ticks will be marked in the Timeline (which is at the very bottom of the application).

Date time ticks will be marked for Alarms, Events and Trends in solid blue colour

44.5.2 Export to XML

This feature saves the Alarms and Event as a XML file.

Press "Export to XML" button. Give a filename and save as (*.xml)



44.5.3 Export to Excel

44.5.3.1 Events Log / Trends Log

Press either the "Events Log" or "Trends Log" button to save the data as an Excel file.

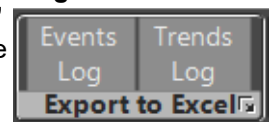

Note: To change the second column in excel sheet to display correct date time, you will need to change the default format of the excel column.

Perform the following steps in exported excel.

Choose whole of second column

"EventTime" (click a cell in second column press Ctrl+ space bar)

Right click select "Format Cells".

Choose "Custom" and type in as "dd/mm/yyyy hh:mm:ss.000" in the "Type" field of excel sheet, and press "OK".

44.5.4 Search Filter

This feature is to search entries in Alarm Event window.

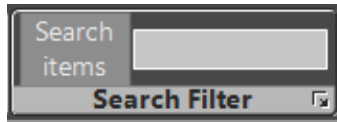

Type (for e.g.: "PIP") in Search filter textbox. Press "Search items" button.

All entries with text "PIP" will be displayed in Alarm Event window

44.5.5 Load Trend data by day

Log Viewer application is ready to read and display

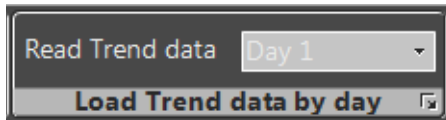

the Trend data, once the date time ticks are marked in the Timeline for Trends.

Choose any day by pressing the "Read Trend data" drop down box (for e.g.: Day 14). Or type manually the day as "Day 14"

Wait around 60s (might take little longer depending on the size of loaded data. Trend data is logged every second for the whole day. When the wait cursor turns to default mouse cursor, "Trends / Real-time window" will be opened in right side of the application with Trends data for the chosen day (e.g.: Day 14).

To open another day of trend data, repeat the above steps.

44.5.6 Trends Settings

44.5.6.1 Trends button

Press "Trends" button in the "Trend Settings" panel.

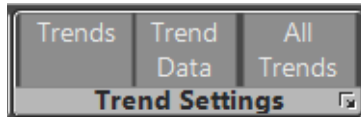

Trends edit panel will be displayed; where up to 6 trend parameters can be selected by pressing drop-down box.

Default parameters:

- Display 1: O2
- Display 2: MAP
- Display 3: Vmin
- Display 4: SpO2
- Display 5: PEEP
- Display 6: PIP

Press "OK" button in the Trends edit panel. It might take few seconds to display the Trends waveform
Pressing the play icon "▶" in the menu bar, plays the trends waveform.

The speed of the trend waveform can be adjusted by scrolling the "Playback Speed" scroll bar in the menu.

Waveform play can be stopped at any time by pressing the icon "||"

Waveforms can be scrolled to the desired date-time by adjusting the "Position" scroll bar.

Waveform screen can be hidden by pressing the "Hide Trend" button at the top right corner

"Hide Trend" button will only be available when the trend waveforms are shown.

44.5.6.2 Trend Data button

If after viewing trends and returning to the data view, this button will re-display the trend data in its numerical table if it not visible.

44.5.7 All Trends

"All Trends" button in Trend Settings panel loads upto 14 days trends and export to excel in one button click (thus removing the manual process of selecting each day of trend, loading the data and then exporting to excel.

Caution: All Trends export can take a very long time from few seconds to 30 minutes or more (depending on how long the ventilator was running)

44.5.8 Load Real-time Data

44.5.8.1 Wave Data

The Wave Data button will load the real-time wave date using a 30 second sampling rate.



44.5.8.2 Entire Waves

The Wave Data button will load the real-time wave date using a 50 millisecond sampling rate.

Caution: An Entire waves load will take approximately 10 minutes.

44.5.8.3 Waves

Waves edit panel will be displayed; where up to 6 waveforms can be selected by pressing drop-down box.

Default parameters:

- Display 1: Pressure wave
- Display 2: Flow wave
- Display 3: Volume wave
- Display 4: EtCO₂ wave
- Display 5: SpO₂ wave
- Display 6: Off

Press "OK" button in the Wave edit panel.

Pressing the play icon "▶" in the menu bar, plays the trends waveform.

The speed of the trend waveform can be adjusted by scrolling the “Playback Speed” scroll bar in the menu.

44.5.9 “UTAS” option

This is a password protected feature not for general use.



44.5.10 Timeline

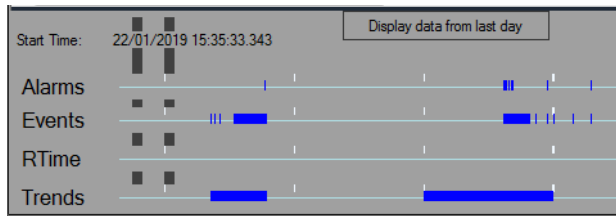

At the bottom of the application, there is a bar showing the Start time and End time of the exported data (which is 14 days of data).

There are two vertical lines in the timeline (called left cursor and right cursor)

Alarms, Events and Trends data will be shown in solid blue colour in the timeline, so the user can drag these cursors to the blue coloured region. And Alarms and Events (and trends if loaded) will be automatically updated based on the left and right cursor positions.

First time, click on the left cursor and drag the cursor.

44.5.11 Display data from last day

Press this button in Time line to display events, alarms and trends in the last day (14th day).

This page is intentionally left blank.

45. Training (User)

SLE provide user training courses for the SLE6000 infant ventilator.

End-User Training

SLE, or their Distributor, offers clinical support to all users of SLE ventilators. This is always coordinated through the local Sales Specialist or Distributor to ensure effective use of your time. Over the course of the ventilator installation, a specialist will ensure that users receive in-depth training on SLE products.

On-Going Training

Once the ventilator has been installed and commissioned, SLE or your local Distributor's clinical support staff, will spend time in the NICU, with the medical and nursing staff, to answer any questions that may arise and offer further support.

Specialist in vivo Workshops

SLE supports clinician-led ventilation seminars; the seminars are aimed at consultant level Neonatologists and Paediatric Intensivists.

In some countries SLE will sponsor a clinical expert to present a seminar using a prepared animal lung to demonstrate lung recruitment. This is usually aimed at Registrars, House Officers and senior nursing staff.

Additionally, SLE runs a series of in vivo ventilation workshops around the world each year. These courses are intended for clinicians and focuses on lung protective strategies. Using an in vivo model, these seminars are hands-on and include both conventional and high-frequency oscillation ventilation.

Please contact SLE Ltd.

Please ask for "End user training"

Telephone: **+44 (0)20 8681 1414**

Fax: **+44 (0)20 8649 8570**

E-mail: **sales@sle.co.uk**

46. Training (service)

SLE provide service training courses for the SLE6000 infant ventilator.

The courses cover the servicing and maintenance of hardware and software of the SLE6000 infant ventilator.

Please contact SLE Ltd.

Please ask for "Service training"

Telephone: **+44 (0)20 8681 1414**

Fax: **+44 (0)20 8649 8570**

E-mail: **service@sle.co.uk**

This page is intentionally left blank.

Consumables & Accessories



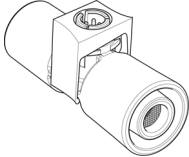
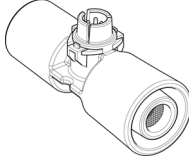
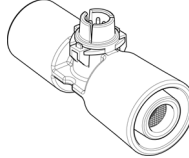

47. Consumables & Accessories



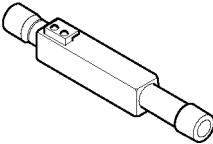
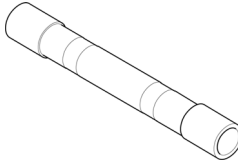
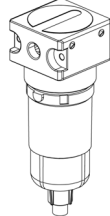

Consumable Items	Image	Part No
10mm Patient Circuit (Single use). Box of 15		BC6188/15
10mm Patient Circuit (Single use) Dual Heated Wire with chamber. Box of 7		BC6188/DHW/07
10mm Patient Circuit (Single use) Dual Heated Wire without chamber. Box of 15		BC6288/DHW/15
Nitric oxide adaptor kit (Single use) for use with BC prefix patient circuit.		BC6110/KIT/5
Dual Exhaust Hose Assembly for nitric oxide scavenging		N4110/10
Flow sensor (autoclavable).		N5402-REV2
Flow sensor (Sterile Single use). Pack of 5		N5302/05
Flow sensor (Sterile Single use). Pack of 50		N5302/50

Warning. Use of cables other than those listed below may result in increased electromagnetic emissions or decreased electromagnetic immunity

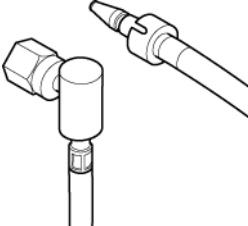
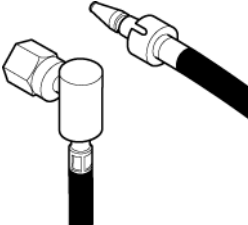
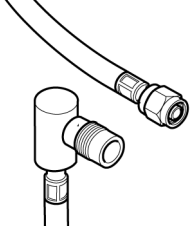
Accessories	Image	Part No
SLE6000 Core Configuration Software Module		Z6000/COR
SLE6000 HFOV (including HFOV VTV) Software Module		Z6000/HFO
SLE6000 Single Limb NIV Software Module		Z6000/SLN
SLE6000 Oxygen Therapy Software Module		Z6000/O2T
SLE6000 VTV (Conventional Ventilation) Software Module		Z6000/VTV
SLE6000 ETCO2 Monitoring Software Module		Z6000/ETC
SLE6000 Masimo SpO ₂ Monitoring Software Module		Z6000/SPO
SLE6000 NIPPV Tr. Software Module		Z6000/NIP
SLE6000 OxyGenie [®] O ₂ Closed Loop Software Module		Z6000/CLP
Flow Sensor connecting cable with anti microbial coating. (1.5 m)		N6656
SLE uSpO ₂ cable (Masimo SET) (Cable 1.8 m) and LNCS sensor sample pack kit		L6000/SP2/KIT
MicroPod™ Microstream™ etCO ₂ module		LETC2/RS03000
MicroPod™ Mounting Kit (Vesa)		LETC2/9279
MicroPod™ Mounting Kit (Clip)		LETC2/9283
MicroPod™ Calibration Software Kit (LEMO connection cable 1 m)		LETC2/9348
Mains cable (1.5m) UK 3 pin plug & 90° IEC connector		M0255/095
Mains cable (1.5 m) Shuko (European) plug & 90° IEC connector		M0255/096
Mains cable (1.5 m) Nema North American) plug & 90° IEC connector		M0255/097
RS232 cable (2 m)		L6000/232/001
VGA video cable (Male to Male) 2m		L6000/VGA/001
Nurse call cable (3 m fully wired)		L6000/NCW/001
Nurse call cable (3 m normally open)		L6000/NCO/001
Nurse call cable (3 m normally closed)		L6000/NCC/001
DC input cable (2 m)		L6000/ODC/001

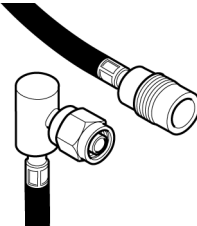
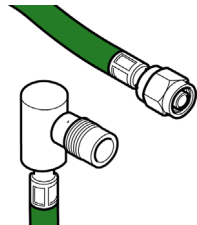
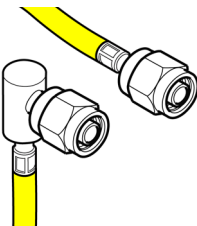
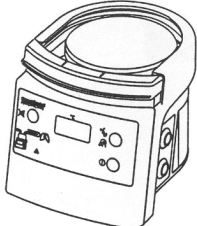
Accessories

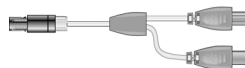
Accessories	Image	Part No
Spare exhalation Block.		N6622
Silencer (Reusable)		N2186/RS
Oxygen water trap assembly		L6000/XWT
Fully automatic water trap bowl.		N9606/01
O ₂ hose, 3 metres length - 90° NIST nut to BS probe. Tube colour white.		N2035/RAC/001
Air hose, 3 metres length - 90° NIST nut to BS probe. Tube colour black.		N2199/RAC/001
O ₂ hose, 3metres length - 90° DISS Male to DISS Female. Tube colour White		N2035/RDS/001

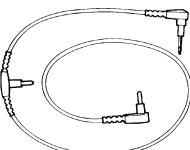
Accessories	Image	Part No
Air hose, 3 metres length - 90° DISS Female to DISS Male. Tube colour Black		N2199/RDS/001
O ₂ hose, 4.3 metres length - 90° DISS Male to DISS female. Tube colour Green		N2035/RAD/GRN
Air hose, 4.3 metres length - 90° DISS Female to DISS Female. Tube colour Yellow		N2199/RAD/YEL
MR850 Humidifier Heater Base. (230V) For UK Only.		N3850/00
MR850 Humidifier Heater Base. (230V)		N3850/01
Heater adaptor for use with Single Use patient circuits & chambers and MR850 Humidifier Heater Base.		N5600
Dual Heater adaptor for use with Single Use patient circuits & chambers and MR850 Humidifier Heater Base.		N5601
MR858 Heater adaptor for use with Re-usable patient circuits & chambers and MR850 Humidifier Heater Base.		N3858
MR860 Dual Temperature Probe (for 850 F&P humidifier).		N3860

Accessories

Accessories	Image	Part No
Test Lung.		N6647
Medicart with two locking castors, basket, hose hook and medi rails.		N6690
Aerogen Solo USB controller Starter Kit - UK		L1025/SLU/0UK
Aerogen Solo USB controller Starter Kit - Northern Europe		L1025/SLU/0NE
Aerogen Solo USB controller Starter Kit - Central Europe		L1025/SLU/0CE
Aerogen Solo USB controller Starter Kit - East Europe		L1025/SLU/0EE
Aerogen Solo USB controller Starter Kit - Southern Europe		L1025/SLU/0SE
Aerogen Solo USB controller Starter Kit - Scandinavia		L1025/SLU/0SC
Aerogen Solo USB controller Starter Kit - Russia & Baltics		L1025/SLU/0RB
Patient Circuit Arm.		N6627/212
Instructions for use for SLE6000. (English)		UM165/UK
Instructions for use for SLE6000. (French)		UM165/FR
Instructions for use for SLE6000. (Spanish)		UM165/ES
Instructions for use for SLE6000. (German)		UM165/DE
Instructions for use for SLE6000. (Italian)		UM165/IT
Instructions for use for SLE6000. (Turkish)		UM165/TR
Instructions for use for SLE6000. (Polish)		UM165/PL
Instructions for use for SLE6000. (Portuguese)		UM165/PT
Instructions for use for SLE6000. (Dutch)		UM165/NL
Instructions for use for SLE6000. (Russian)		UM165/RU
Instructions for use for SLE6000. (Ukrainian)		UM165/UA
Instructions for use for SLE6000. (Greek)		UM165/GR
Instructions for use for SLE6000. (Swedish)		UM165/SE
Instructions for use for SLE6000. (Chinese)		UM165/CN
Instructions for use for SLE6000. (Japanese)		UM165/JP
Service Manual for SLE6000 (English Only)		SM38









48. Glossary







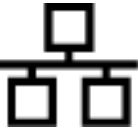
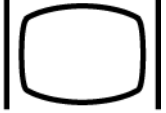



ASCII	(American Standard Code for Information Interchange) is the most common format for text files in computers. Not suitable for non-English letters but suitable for numerics.
O ₂	Oxygen
°C	Degrees Celsius
°F	Degrees Fahrenheit
»	Approximately equal to
bar	Unit of Barometric Pressure
BPM	Breaths Per Minute
BTPS	Body temperature and pressure saturated
C20/C	Ratio of the compliance during the last 20% of the respiratory cycle compared to whole cycle
cm	Centimetre
cmH ₂ O	Centimetres of water
CMV	Continuous Mandatory Ventilation
Compl. or C	Compliance
CPAP	Continuous Positive Airway Pressure
CPU	Central processing unit
DCO ₂	Gas transport coefficient, based on tidal volume and frequency.
DHW	Dual heated wire
dP	Delta Pressure
DPI	Dots per inch
EMC	Electromagnetic Compatibility
ES	External Sensor
ESMO	External Sensor & Monitor
ET	Endotracheal
EtCO ₂	End-tidal CO ₂
GHz	Gigahertz
GMDN	Global Medical Device Nomenclature.

HFOV	High frequency oscillatory ventilation
HFNC	High flow nasal cannulae
Hz	Hertz (Cycles per second)
I:E	Inspiratory: Expiratory Ratio
Insp Time	Inspiratory Time
ISM	Industrial, scientific, and medical
kg	Kilogram
kHz	Kilohertz
LED	Light Emitting Diode
LF	Low Frequency
l/min	Litre per Minute
mbar	Millibar
MHz	Megahertz
MMS	Messaging Management System
ml	Milliliters
ms	Millisecond
Mean P	Mean Pressure
NEEP	Negative End Expiratory Pressure
NIPPV	nasal intermittent Positive Pressure Ventilation
NCPAP	Nasal Continuous Positive Airway Pressure
NHFO	Nasal High Frequency Oscillation
MAP	Mean airway pressure
MO	Monitor output
O ₂ %	Percentage Oxygen
PCLC	Physiological closed loop controller
PEEP	Positive End Expiratory Pressure
PIP	Peak Inspiratory Pressure
POST	Power on self test
PPM	Planned preventative maintenance
PR	Pulse Rate
psi	Pounds per Square Inch
PSU	Power Supply Unit
PTV	Patient Triggered Ventilation
RF	Radio Frequency

RR	Respiratory Rate
Resist. or R	Resistance
RS232C	RS232 is a long established standard for low speed serial data communication, "C" being the current version.
SaO ₂	Saturated arterial oxygen
SIMV	Synchronised Intermittent Mandatory Ventilation
SIQ	Signal Identification and Quality
SpO ₂	Peripheral capillary oxygen saturation
STPD	Standard temperature and pressure dry.
Ti	Inspiratory time
VTV	Volume Targeted Ventilation
tcPCO ₂	Transcutaneous Carbon Dioxide
tcPO ₂	Transcutaneous Oxygen
UI	User interface
USB	Universal Serial Bus
VLBW	Very low birth weight
VGA	Video Graphics Array
Vol. Cont.	Volume Control
Vexp(ml)	Expired Volume Control in millilitres
Vinsp(ml).	Inspired Volume in millilitres
Vmin (l)	Minute Volume in litres
Vt	Tidal volume
Vte	Tidal Volume expiratory







49. SLE6000 markings and symbols
49.1 Description of ventilator markings

	General Warning Symbol
	Caution Symbol
	Warning, Electricity
	Refer to Instruction Manual/Booklet
	Type BF Applied Part Symbol
	Nurse Symbol
	Ethernet port
	VGA port
	Display port







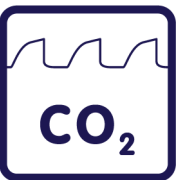

	USB port
	Symbol for Equipotentiality
	Direct Current icon
	Device weight
	On/Off
	CE mark and notified body number
	Serial number
	Manufacturer
	Date of manufacture
	WEEE Symbol







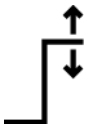

49.2 Description of option markings

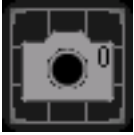







.Located on side of ventilator

	Core software specification and version number software option.
	HFO ventilation software option. HFOV, HFOV+CMV & nHFOV
	Volume Targeted Ventilation software option.
	Non invasive software option. nCPAP & DuoPAP
	Non invasive software option. NIPPV Tr.
	Masimo SpO ₂ monitoring software option.
	Microstream™ etCO ₂ monitoring software option.





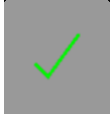

49.3 Description of interface markings.

	Warning Symbol
	Mains power icon
	Direct Current icon
	Battery icon 100%
	Battery icon 0%
	Fuse Symbol
	Audio paused
	Alarm inhibit
	Upper alarm limit





	Lower alarm limit
	Screen capture
	Backspace
	Close
	Scroll up
	Scroll down
	Zoom in (Zoom)
	Zoom out (Zoom)
	Scroll left (Cursor)

	Scroll right (Cursor)
	Scroll left (Scroll)
	Scroll right (Scroll)
	HFO in expiration phase only.
	HFO in inspiration and expiration phase.
	Locked screen
	Play
	Pause
	Confirm

49.4 Description of Micropod™ markings.

	Caution
	Type BF Defibrillator proof protection
	Gas inlet
	Gas outlet
	For prescription use only
	CE mark
	WEEE Symbol

49.5 Description of Packaging markings.

	Stack limit of 3 cartons
	Recyclable carton
	This way up.
	2 person handling.

SLE reserves the right to make changes without prior notice in equipment, publications and prices as may be deemed necessary or desirable.

Revision History

Rev.	Date	Change ref.
1	30/04/18	Initial issue.
2	18/07/18	CR1709
3	16/11/18	CN 101 CR 1746 CR 1800 CR 1801 CR 1802 CR 1824 CR 1858
4	21/11/18	CR 1889
5	14/03/19	CR 1918 Mantis 1768 CR 1951 Mantis 1978 CR 1952 Mantis 2185 CR 1962 Mantis 2203 CR 2316 Mantis 2345 Mantis 2361
6	26/03/19	CR 2368
7	11/06/19	CR 2148
8	08/07/19	CN 139 CR 2428
9	08/11/19	CN 160
10	31/01/20	CN 176
11	19/05/20	CN 181 CR 2788 CR 2806
12	02/07/20	CR 2854 CR 2926 V2.0.98
13	11/02/21	CR 2946 CR 3083 CR 3085 CR 3191 CR 3192
14	26/04/21	CR 3270 CR 3279 CR 3280
15	09/07/21	CR 3357
16	21/04/22	CR 3366 CR 3372 CR 3372

 +44 (0)20 8681 1414

 +44 (0)20 8649 8570

 sales@sle.co.uk

 www.sle.co.uk



SLE Limited
Twin Bridges Business Park
232 Selsdon Road
South Croydon
Surrey
CR2 6PL
UK



When the smallest thing matters